

**PLANT McDONOUGH-ATKINSON  
CCR SURFACE IMPOUNDMENTS  
(CCR UNIT AP-2, COMBINED CCR UNIT AP-3/4)  
COBB COUNTY, GEORGIA  
PART B SECTION 2 – ENGINEERING REPORT**

---

FOR



**Georgia  
Power**

**Revision 01 – November 2020**

Golder Associates Inc.  
5170 Peachtree Road  
Building 100, Suite 300  
Atlanta, GA 30341  
(770) 496-1893



## Executive Summary

Golder Associates Inc. (Golder) has compiled supporting calculations for the closure of inactive CCR Units AP-2 and Combined Unit AP-3/4 for Plant McDonough-Atkinson (Plant McDonough), owned and operated by Georgia Power Company (Georgia Power). This report provides a narrative of the closure design presented in the Closure Plan Drawings in Part A of this permit application under the following main categories:

- Geotechnical Design
- Contact Water Management System
- Final Cover System
- Surface Water Management

This report and the appended detailed calculations are intended to meet the requirements of the Georgia Solid Waste Management Rules for Coal Combustion Residuals (391-3-4-.10) and to support the presented Closure Plan Drawings.

# Table of Contents

<b>1.0</b>	<b>INTRODUCTION</b>	<b>1</b>
<b>2.0</b>	<b>GEOTECHNICAL DESIGN</b>	<b>2</b>
2.1	General	2
2.2	Slope Stability Assessment Methodology	2
2.2.1	Storage Pool Conditions	3
2.2.2	Surcharge Pool Conditions	3
2.2.3	Seismic Loading Conditions	3
2.2.4	Liquefaction Assessment	3
2.3	Slope Stability Assessment Results	4
2.4	Geotechnical Analysis Conclusions	4
<b>3.0</b>	<b>CONTACT WATER MANAGEMENT SYSTEM</b>	<b>5</b>
3.1	Contact Water Generation	5
3.2	Contact Water Management	5
3.2.1	Under Slope Drainage System	5
3.2.2	Toe Drains	6
3.2.3	Contact Water Conveyance and Sump Systems	6
3.3	Contact Water Treatment	6
<b>4.0</b>	<b>FINAL COVER SYSTEM</b>	<b>7</b>
4.1	General	7
4.2	Alternative Final Cover Design	8
4.3	Veneer Stability Analysis	8
4.4	Final Cover Anchor Trench	8
4.5	General	8
4.6	Surface Water Management Analysis	8
<b>5.0</b>	<b>CLOSING</b>	<b>9</b>
<b>6.0</b>	<b>REFERENCES</b>	<b>10</b>

APPENDICES

**APPENDIX A**

Material Properties Calculations Package

**APPENDIX B**

Stability Analysis Figures for

AP-2 and AP-3/4

**APPENDIX C**

Seismic Hazard Calculation Package

**APPENDIX D**

Liquefaction Assessment Calculation Package

**APPENDIX E**

Settlement Analysis Calculation Package

**APPENDIX F**

Under Slope Drainage System

**APPENDIX G**

Alternative Final Cover Evaluation

**APPENDIX H**

Veneer Stability Analyses Calculation Package

**APPENDIX I**

Anchor Trench Calculation Package

**APPENDIX J**

Hydrology and Hydraulic Design for AP-3/4

**APPENDIX K**

Analysis of Permanent Detention Pond 3 Outlet Structure

## 1.0 INTRODUCTION

Golder Associates Inc. (Golder) and Georgia Power Company (Georgia Power) have prepared design calculations to support the design and permitting of CCR Unit AP-2 and Combined Unit AP-3/4 at Plant McDonough-Atkinson (Plant McDonough or “the site”). Plant McDonough is a power generating facility, owned and operated by Georgia Power, and historically operated as a coal fired facility, utilizing coal combustion residual (CCR) surface impoundments for the disposal of CCR material on-site. In 2011, Plant McDonough ceased coal-fired electric generating activities, and subsequently ceased placing CCR in the units, resulting in AP-2, AP-3 and AP-4 becoming inactive CCR surface impoundments prior to closure construction activities. In January 2016, closure activities were initiated for the units, and consisted of closure by removal of CCR for AP-2, and a combination of closure by removal and consolidating and closing in place as a combined unit for AP-3 and AP-4, referred to as Combined Unit AP-3/4.

Closure activities for AP-2 and AP-3/4 were conducted following the closure design presented in the Closure Plan Drawings of Part A of this permit application. The overall closure design objectives consist of the following key aspects:

- A stable containment system under expected final conditions
- Perimeter containment berms that are used to contain the CCR materials once the grades of the closed unit rise above the perimeter berm elevation (AP-3/4)
- A contact water management system to collect water that has contacted CCR material for storage and treatment
- A final cover system to minimize infiltration of surface water into the unit during long term conditions
- A surface water management system used to control runoff from the units and direct it to a detention pond to reduce discharge from the units to levels below existing conditions

The Closure Plan Drawings provides detailed grading and associated details depicting the closure design that are used as a basis for the design approach. Closure design calculations are included as appendices to this report. This document provides a summary of the various calculations and a brief narrative on the design details for each closure design element. Key design elements include the following:

- Geotechnical Design
- Contact Water Collection System
- Final Cover System
- Surface Water Management

Each design element contains several design calculations and these are discussed in more detail in this report.

## 2.0 GEOTECHNICAL DESIGN

### 2.1 General

A key element of the closure design is associated with the geotechnical stability of the closed units both during closure construction and during post closure. There are various elements related to the assessment of the geotechnical stability and performance of the units:

- Geotechnical Material properties
- Global slope stability and settlement of the units under final conditions

This geotechnical design discussion presents Golder's stability evaluation of the containment berms (dikes) surrounding inactive CCR Units AP-2, AP-3, and AP-4 at Plant McDonough related to the requirements in the US EPA's 2015 Final Rule on the Disposal of Coal Combustion Residuals (CCR; EPA Rule) and the State of Georgia Solid Waste Management Rule 391-3-4-.10.

This report presents the calculated geotechnical stability and settlement of the final closure condition of the AP-2 and AP-3/4 units. As previously described, CCR materials have been excavated from within Unit AP-2, and units AP-3 and AP-4 are being closed as Combined Unit AP-3/4 using a combination of closure by removal to consolidate ash into a smaller footprint for capping in place. According to section § 257.73(e) of the rule, stability of earth structures must be assessed under four loading conditions:

- Storage Pool (§ 257.73(e)(i))
- Surcharge Pool (§ 257.73(e)(ii))
- Seismic Loading Conditions (§ 257.73(e)(iii))
- Post-Seismic Liquefaction Conditions (when liquefaction susceptible materials are present; § 257.73(e)(iv)).

Additionally, the integrity of the final cover system has also been evaluated for anchor trench and veneer stability requirements, as further discussed in Section 4.2:

- Veneer Stability Analysis (where applicable, i.e. at the gravel access road locations)
- Anchor Trench Requirements

### 2.2 Slope Stability Assessment Methodology

Stability safety factors were evaluated for each of the loading scenarios using the computer program SLIDE 7.0 Version 7.031 (2018). As required by the EPA rule, a general limit equilibrium (GLE) method (Morgenstern and Price) was used to calculate factors of safety, and the factor of safety is calculated by dividing the resisting forces by the driving forces along the critical slip surface.

Stability was evaluated along three cross-sections for AP-2 and four cross-sections at AP-3/4 as shown in Appendix B. Subsurface stratigraphy at each cross-section was developed from data from historical boring and well records and data collected during Golder's subsurface explorations completed in multiple mobilizations from October 2015 to January 2016. Similarly, geotechnical material properties were developed for the dike, foundation, and impounded materials from the references mentioned herein. The Material Properties Calculation Package (Appendix A) provides details on Golder's geotechnical exploration and evaluation of geotechnical data.

The water levels used in stability analyses are reflective of long-term post-closure conditions.

## 2.2.1 Storage Pool Conditions

Golder modeled the storage pool using the long-term water levels at post-closure conditions. Long-term water levels at AP-2 are below the lowest grade of the impounded area, and any stormwater routed to AP-2 will be pumped out prior to future development backfill conditions; thus, AP-2 will not retain a storage pool. For AP-2 maximum pool storage stability analyses, Golder used long term water levels estimated for AP-2.

Likewise, AP-3/4 will not retain a storage pool. Water levels in AP-3/4 are modelled to drop below the bottom of the impounded ash in the long term due to capping and active and passive dewatering. For conservatism, Golder used the water levels at the end of dewatering for maximum pool storage stability calculations.

## 2.2.2 Surcharge Pool Conditions

For the surcharge pool scenario, Golder considered the impact of the 100-year, 24-hour rain event for Atlanta, GA. This event was calculated to cause a temporary pool of elevation 781.3 ft-msl to develop in AP-2 (Hydrology and Hydraulic Design for AP-2). AP-2 dike stability under surcharge pool was calculated with this pool elevation.

At AP-3/4, the rain event will cause storm water flow in the lined channels on the pond final cover, but will not significantly impact the water level below the final cover. Thus, Golder evaluated the stability of AP-3/4 slopes with channels to the flow depths (fully flowing) as calculated based on the Hydrology and Hydraulic Design for AP-3/4. The table below lists the depth of water considered in channels at each section.

Section	Channel Flow Depth (ft)
3/4A (North)	8.7
3/4A (South)	0.2
3/4B	9.3
3/4D	1.2
3/4J	9.5

## 2.2.3 Seismic Loading Conditions

Factors of safety for stability under seismic loading conditions were calculated based on the earthquake hazard corresponding to a probability of exceedance of 2% in 50 years (2,475 year return period). The Bray and Travararou displacement-based seismic slope stability screening method was used to evaluate the seismic stability. For this method, a pseudo-static coefficient corresponding to an allowable displacement of six inches (15 cm) is applied as a horizontal force in the static stability model. The pseudo-static coefficient for the above stated criteria was calculated to be 0.029g (g = standard gravity). Details on the calculation of the pseudo-static coefficient are available in the Seismic Hazard Calculation Package (Appendix C).

## 2.2.4 Liquefaction Assessment

The CCR Rule specifies a required factor of safety of 1.2 against liquefaction for pond impoundment structures (§ 257.73(e)(iv)). The dikes and foundation soils at the location of the AP-2 and AP-3/4 analysis sections were evaluated for liquefaction susceptibility, and the calculated factors of safety against liquefaction are above 1.2. Details on the calculation of the liquefaction susceptibility are available in the Liquefaction Assessment Calculation Package (Appendix D).

## 2.3 Slope Stability Assessment Results

The table below presents the results of the slope stability analyses for the AP-2 and AP-3/4 dikes. For all cases analyzed, the calculated factors of safety are in excess of those required in Sections § 257.73(e)(i) to (iv) of the CCR Rule. The detailed stability results are presented in Figures 3 through 10 of Appendix B.

Long-Term Post-Closure Stability Analysis Results				
Analysis Case	Max. Storage Pool	Max. Surcharge Pool	Seismic	Post Liquefaction
Rule Section	§ 257.73(e)(i)	§ 257.73(e)(ii)	§ 257.73(e)(iii)	§ 257.73(e)(iv)
Target Factor of Safety	1.5	1.4	1.0	1.2
Cross-Sections	Factor of Safety			
Surface Impoundment AP-2				
2A	1.9	1.9	1.8	Not Applicable
2B	1.9	1.9	1.8	
2C	1.8	1.8	1.7	
Surface Impoundment AP-3/4				
3/4A (North)	2.1	2.1	1.8	Not Applicable
3/4A (South)	1.6	1.6	1.5	
3/4B	2.1	2.1	1.8	
3/4D	1.8	1.8	1.6	
3/4J	2.1	2.1	1.9	

## 2.4 Geotechnical Analysis Conclusions

Golder evaluated the slope stability of dikes surrounding AP-2 and AP-3/4 at Plant McDonough in accordance with the EPA Rule on the Disposal of Coal Combustion Residuals. Specifically, the containment berms (dikes) were evaluated for stability in the four loading scenarios presented in section § 257.73(e) of the EPA Rule:

- Storage Pool (§ 257.73(e)(i))
- Surcharge Pool (§ 257.73(e)(ii))
- Seismic Loading Conditions (§ 257.73(e)(iii))
- Post-Seismic Liquefaction Conditions (when liquefaction susceptible materials are present; § 257.73(e)(iv)).

For each loading case, the cross section analyzed under this study were found to meet the target factor of safety presented in the EPA rule. Additionally, Golder performed veneer stability for the gravel access road on the final cover.

- Settlement Analysis

Long-term settlement potential for AP-3/4 was calculated and used to evaluate the potential for grade reversals or other settlement induced issues. In general, CCR is much less susceptible to long term settlement than typical municipal solid waste (MSW) and Construction & Demolition (C&D) waste masses and as such liner components and drainage grades are less prone to settlement induced issues in CCR closures. The settlement evaluations for



the closed AP-3/4 conditions consider settlement following closure from dewatering of the CCR and indicate that no settlement induced issues are calculated to occur following closure as detailed in Appendix E.

#### ■ Veneer Stability Analysis

Long-term and short-term veneer stability analyses were performed for the critical the access road conditions applicable to AP-3/4, including incorporation of equipment acceleration on the roads and were found to meet the required factors of safety as detailed in Appendix H.

#### ■ Anchor Trench Analysis

Closure cover liner anchorage was evaluated, and 2 ft. deep by 2 ft. wide anchor trenches were evaluated to be adequate for the closure as detailed in Appendix I.

### **3.0 CONTACT WATER MANAGEMENT SYSTEM**

AP-2 has fully removed all CCR materials from the unit during closure and as such does not require long term or post closure contact water management.

A primary objective of the AP-3/4 closure configuration is to limit long term contact of CCR with surface and ground water. This goal is achieved through capping of the CCR unit with a synthetic liner and removal of CCR materials from the topographic low-lying areas of AP-4 to allow for the long term drying of the stored CCR within the closed AP-3/4 unit.

The contact water management system for Combined Unit AP-3/4 provides for a method of controlled collection and treatment of contact water as a result of a series of drains and temporary dewatering wells located along the eastern and southwestern slope areas of AP-3/4.

The temporary dewatering wells are included as part of efforts to help expedite the natural long drying of CCR within the Combined Unit AP-3/4. These dewatering wells are proposed to be operated until such time that the area of influence around each well reaches equilibrium conditions, following which they are schedule to be decommissioned on a well by well basis when no longer needed to accelerate natural drainage.

#### **3.1 Contact Water Generation**

Contact water collected from the closed conditions of AP-3/4 is expected to be a result of the active and passive lowering of water levels within the inactive surface impoundment from its pre-closure conditions. Infiltration through the final cover system is designed to be limited, as discussed in Section 4.0 below.

#### **3.2 Contact Water Management**

Contact water from AP-3/4 is designed to be collected via a combination of the under slope drainage system, existing dam toe drains, and the temporary dewatering wells and forcemain as identified in the Closure Plan Drawings presented in Part A of this permit submittal. The contact water forcemain will convey water to the contact water sump, which along with the under slope drainage system sump will be pumped and undergo water treatment per the facility's water treatment plan.

##### **3.2.1 Under Slope Drainage System**

The under slope drainage system for AP-3/4 is designed for the collection and conveyance of contact water at the eastern slope of the proposed closed design for AP-3/4. Details for the under slope drainage system are located in the Plant McDonough AP-2 and AP-3/4 Closure Plan Drawings (Section 10 of Part A). The under slope drainage system is designed to collect interstitial seepage from the covered CCR mass and serve as the drainage

layer for water that has contacted the CCR. The under slope drainage system consists of a combination of on-slope and toe drainage systems. The on slope collection system consists of 15-ft. wide geocomposite strips located below the lower portions of the soil buttress, and 3-ft. by 3-ft. sand trench drains spaced 25 ft. apart along the outer face of the eastern slope. The on-slope systems are hydraulically connected and convey flows to toe collection trenches with 4-in. or 6-in. nominal diameter HDPE drainage pipes within gravel drainage trenches. The under slope drainage system flows are directed via gravity to the under slope drainage system sump. Detailed calculations for the under slope drainage system are presented in Appendix F.

The in sump pump system for the under slope drainage sump is included in a 24 inch HDPE riser access pipe and outfitted with level monitoring and controls placed at the ground surface. Pumped flows from the under drain sump are directed to the combined AP-3/4 contact water collection sump being constructed within the lower portion of the eastern soil buttress, and then pumped and conveyed to the AP-3/4 water treatment area for treatment and discharge. If in the future flows are limited as expected, Georgia Power Company's long term contact water plans may either continue on-site treatment or potentially transition to a system of storage followed by conveyance to publicly owned treatment works (POTW) for treatment and discharge.

### **3.2.2 Toe Drains**

The original construction of the AP-3 and AP-4 dams included internal drainage with toe drain outlets. The toe drains have historically been monitored with flows collected and directed to the AP-4 pond in recent years. The AP-3 toe drains were confirmed to be dry during the early portions of closure and were abandoned via grouting as part of the AP-3/4 closure efforts.

Existing toe drains for the AP-4 dam are located along the eastern portions of the AP-4 dam and were retrofitted in past efforts by Georgia Power to be collected at a series of sump locations for pumping to AP-4. As part of CCR closure efforts the toe drains to remain and not be over excavated by the lowering of the AP-4 dam will continue to be collected in sumps and directed to the post closure contact water collection sump being constructed at the toe of the eastern portion of the AP-4 slope. Flows into the AP-4 contact water collection sump will be pumped to the water treatment area for treatment prior to discharge through the site's AP-4 NPDES outfall.

The final toe drain locations and configurations are presented in the Closure Design Plans.

### **3.2.3 Contact Water Conveyance and Sump Systems**

Following closure construction activities, the contact water conveyance system is comprised of seven (7) dewatering wells designed to withdraw a combined contact water flow rate of 50 gallons per minute (gpm). Contact water is then routed to the twin eight-inch diameter precast sumps located to the east of the AP-3/4 closure.

## **3.3 Contact Water Treatment**

All contact water collected through the under slope drainage system and contact water conveyance system will be collected at the sump location and routed to the wastewater treatment system located south of Combined Unit AP-3/4. The water treatment facility is located on a built platform over an area of natural high ground to the south of AP-3/4 and adjacent to the closed AP-4 outfall area. Following pumping of CCR contact water into the wastewater treatment system, the treated water is ultimately discharged through the existing permitted NPDES outfall at AP-4.

## 4.0 FINAL COVER SYSTEM

### 4.1 General

AP-2 has fully removed all CCR materials from the unit during closure and as such does not require or include a final cover lining system.

The closure of AP-3/4 has been designed with a final cover system that consists of two options for the final cover system of the unit.

Option 1 consists of a ClosureTurf™ geosynthetic cap system utilizing a variety of infill options dependent on the designed closure area. The ClosureTurf™ final cover system consists of:

- 18-inch thick (min.) layer of compacted CCR or earthen subgrade material
- 40-mil minimum Agru linear low-density polyethylene (LLDPE) geomembrane
  - 40-mil MicroSpike® LLDPE geomembrane is utilized for closure areas with final cover surface slopes of less than 10 degrees (10°); or
  - 50-mil Super Gripnet® LLDPE geomembrane is utilized with spikes down for cover slope areas greater than 10 degrees (10°)
- ClosureTurf™ (combined 8 ounce per square yard (oz/yd<sup>2</sup>) geotextile and engineered turf layer)
- Turf Infill or Overlying Protective Layer Options
  - Sand infill (0.5-inch minimum) typical design; or
  - Sand infill (0.5-inch minimum) with Armorfill E application; or
  - Hydrobinder® infill (0.75 inch minimum); or
  - Rock or Articulated Concrete Block (ACB) armoring overlying a geosynthetic separation and protection layer.

The Super Gripnet® and MicroSpike® will serve as a flexible membrane liner (FML) barrier to infiltration and are designed such that drainage to convey stormwater off of the FML areas is maintained between the geomembrane and the geotextile of the ClosureTurf™ layer.

Option 2 consists of a closure layer as required for CCR unit closures in §257.102(d)(3)(i) which consists of the following layers:

- 18-inch thick infiltration layer of compacted material with a minimum hydraulic conductivity of  $1 \times 10^{-5}$  centimeters per second (cm/s)
- 6-inch vegetative soil layer with grassy vegetation

The 6-inch vegetative layer of Option 2 is designed to support vegetation over the final cover system. Both final cover system options are designed to overlay the full limits of permanently stored CCR and the interior surfaces of the adjacent containment dike berms. Surface water diversion berms consisting of compacted material are graded into the final cap grading side slopes, and are designed to be overlain by the final cover system.

Details of the final cover system options can be found on Sheet 28 “Closure Details” of the Closure Plan Drawings for Plant McDonough (Part A of this Permit Application).

## 4.2 Alternative Final Cover Design

As indicated in Section 4.1, the final cover system designed for AP-3/4 consists of a ClosureTurf™ geosynthetic cap system utilizing a variety of infill options as delineated in the Permit Closure Design Plans. As part of the closure design, Golder completed an evaluation of the percolation potential and liner performance for the final cover system designed for AP-3/4 in comparison to a CCR Unit final cover system (§257.102(d)(3)(i)). The analysis presents estimates and ranges of the anticipated drainage collected from the final cover system as well as percolation estimates through the geomembrane cover. The performance for the designed final cover system, consisting of ClosureTurf™, demonstrates equivalent or superior performance to a traditional soil cover system, as per regulatory requirements (Georgia Solid Waste Management Regulations, Section. 391-3-4-.10(7) and 40 CFR 257.102(d)). Additional detail on the cover equivalency calculations can be found in Appendix G.

## 4.3 Veneer Stability Analysis

Veneer stability analyses were performed for the final cover system at locations where the final cover system is overlain by another material. For the AP-3/4 ClosureTurf™ final cover system, these are the locations of access roads where a nominal 6-inch gravel layer is placed on the top of a separation and cushion geosynthetic over the Closure Turf™. Veneer stability factors of safety were calculated using the Koerner and Soong method (Koerner and Soong 1998). The maximum slope percent of the access road is 10 percent. Veneer stability analysis was conducted assuming the height of the slope to be the difference between the highest elevation and the lowest elevation of the access road. It should be noted that most of the slopes at the closed units will be shorter than the maximum slope, and thus will be less critical than accounted for in this analysis.

Golder analyzed that both static and equipment loading scenarios meet the required factors of safety. Details on the calculation of the veneer stability analyses and veneer stability analysis methodology, as well as loading specifications are included in the Veneer Stability Analysis Calculation Package (Appendix H).

## 4.4 Final Cover Anchor Trench

The ClosureTurf™ final cover system is designed to cover the AP-3/4 waste limits following consolidation and capping of the CCR material. Appendix I presents the calculated requirements for runout length and anchor trench width and depth for appropriate protection against being compromised by wind and water. An anchor trench with 2 ft depth and 2 ft width is calculated to be adequate for the range of proposed anchorage conditions.

Surface Water Management

## 4.5 General

The surface water management system for combined unit AP-3/4 includes several controls for limiting peak stormwater discharge flows from the closed CCR unit, including attenuation storage in the three (3) designed stormwater retention ponds, minimizing erosion from high velocity flow, and conveying stormwater safely below access roads and other structures. Golder has developed a comprehensive calculation package for the stormwater management system as outlined in Section 5.2 below that consists of a series of ditches, ponds, and culverts.

## 4.6 Surface Water Management Analysis

Appendix J includes a comprehensive surface water management calculation for the closed Unit AP-3/4 conditions. The calculation package estimates run-off for a variety of storm events, ranging from the 2-year, 24-

hour storm event to the 1,000-year, 24-hour storm events under final development conditions for the unit to the stormwater management system's three stormwater retention ponds. Type II rainfall distribution was used for all modeling efforts, and all structures were ultimately designed based on the discharge from the 100-year, 24-hour storm event.

Details of the hydrologic analysis are included in the calculation narrative provided in Appendix J. Three separate watersheds were delineated to route to Detention Pond 1, Detention Pond 2, and Detention Pond 3 located around the outer extents of the closed unit. Terraces and perimeter channels are designed to convey stormwater from the closed CCR unit surface, and are designed to maintain sufficient freeboard under the design storm; these are designed as either HydroTurf or riprap lined channels. Similarly, Armorflex articulated concrete block (ACB) lined downslope groin channels are designed to convey stormwater from the perimeter at the northeast and southeast down to Retention Pond 2. Stilling basins are designed to dissipate energy from flow traveling along the north and south downslope channels (Table 13 of Appendix J). Culverts for road and berm crossings have also been designed and are summarized in Table 15 in the calculation package included in Appendix J.

The detention ponds were also analyzed based on the proposed design for each storm event. The three retention ponds were designed to provide run-off storage capacity, as well as for the attenuation of floods. Detention Pond 1 was designed with an outfall structure to convey stormwater to Detention Pond 2. Detention Ponds 2 and 3 were designed with outfall structures for stormwater discharge. Maximum outflows from Detention Ponds 1, 2, and 3 are estimated to be 12 cfs, 30 cfs, and 9 cfs respectively for the 100-year, 24-hour design storm.

In August 2020, the outlet structure for Detention Pond 3 was further evaluated with regards to outflow and time required to drain the contributing watershed areas following a rain event. Detention Pond 3 is intended to serve as an attenuation pond in order to route surface water following a rain event away from the capped unit, and during normal conditions does not contain surface water. Based on this analysis, presented in Appendix K of this Engineering Report, the low level outlet configuration has been modified to include six 3-inch low level orifice outlets to serve in combination with the upper two stage overflow weirs in the Pond 3 outlet structure. This modification was evaluated to provide for a combination of controlled stormwater conveyance attenuation and control to protect downstream infrastructure, and resulting in drainage times under 1 day for all storm events up to and including the 100-year, 24-hour storm event. The outlet design is included in the Closure Plan Drawings in Part A Section 9 of this Permit Application.

## 5.0 CLOSING

This engineering design report provides a summary of key calculations for the design of the final closure for Plant McDonough's AP-2 and Combined Unit AP-3/4 Inactive CCR Impoundments. Appendices to this report include calculations as discussed herein.

**GOLDER ASSOCIATES INC.**



Gregory L. Hebler, PE  
Principal and Practice Leader



Lizmarie Steel, PE  
Senior Project Engineer

## 6.0 REFERENCES

- Bray, J. D., and Travasarou, T. 2007. Simplified Procedure for Estimating Earthquake-Induced Deviatoric Slope Displacements. *Journal of Geotechnical and Geoenvironmental Engineering*, Vol. 133, No. 4, pp. 381-392.
- Bray, J.D., and Travasarou, T. 2009. Pseudostatic Coefficient for Use in Simplified Seismic Slope Stability Evaluation. *Journal of Geotechnical and Geoenvironmental Engineering*, Vol. 135, No. 9: pp. 1336-1340.
- Koerner, R.M. and Soong, T.Y., 1998, March. Analysis and design of veneer cover soils. In proceedings of the Sixth international Conference on geosynthetics (pp. 1-26).
- Qian, X., Koerner, R. M., Gray, D. H., *Geotechnical Aspects of Landfill Design and Construction*, Prentice Hall, New Jersey, US, 2002. Rocscience (2016), SLIDE Version 7.017.
- USEPA (2015), Hazardous and Solid Waste Management System; Disposal of Coal Combustion Residuals From Electric Utilities, § 40 CFR Parts 257 and 26.

**APPENDIX A**

**Material Properties Calculations  
Package**



**SUBJECT: Geotechnical Material Property Package**  
**Project Number: 1777449**  
**Project Name: Plant McDonough Surface Impoundment Units AP-1, AP-2, and AP-3/4 Closure**  
**Prepared by: JGM** **Checked by: LJ / LS**  
**Date: Jul 2018** **Reviewed by: GLH**

## 1.0 OBJECTIVE

Estimate strength parameters for coal combustion residuals (CCR) in-situ soils and soil fill at Ash Ponds 1, 2, 3, and 4 (AP-1, AP-2, AP-3 and AP-4) located at Georgia Power Company's (GPC) Plant McDonough-Atkinson (Plant McDonough) in Cobb County, GA.

Materials types considered include the following:

- Sluiced CCR
- Stacked / Compacted CCR
- Fill Soils
- Upper Residuuum
- Lower Residuuum

## 2.0 METHOD

Material parameters used in analyses were estimated based on a combination of the following:

- Information collected during Golder's geotechnical investigation in October and November 2015, and Golder's supplemental January 2016 investigation. The field investigation included: cone penetration testing (CPT), standard penetration testing (SPT), fixed piston tube sampling, vane shear testing (VST), and groundwater monitoring data;
- Correlations of strength parameters from CPT data (Lunne et al, Conetec, Robertson, Mayne)
- Geotechnical laboratory testing (Direct Shear, Triaxial, Plasticity, Proctor Compaction, Particle Size, Permeability, etc.);
- Correlations of strength parameters from SPT N-values, plasticity indices, and published values (Mesri and Shahien Plasticity correlations, Peck et al. and Meyerhof, etc.);
- Empirical relationships and/or typical ranges of values for the applicable materials; and,
- Golder's professional experience.

Golder also analyzed data provided in AMEC's 2010 report titled "Report of Dam Safety Assessment of Coal Combustion Surface Impoundments, Plant McDonough, Smyrna, GA." Golder found this data to be consistent with data collected during Golder's various site investigations. Interpretation and analysis of data for each soil type is summarized in the subsequent sections.

### 2.1 Abbreviations / Symbols:

$\phi$ = friction angle	deg = degrees
$\phi'$ = effective friction angle	psi = pounds per square inch
$\phi_r$ = residual friction angle	psf = pounds per square foot
c = cohesion	pcf = pounds per cubic foot
c' = effective cohesion	tsf = tons per square foot
$S_u$ = undrained shear strength	SPT = Standard Penetration Test
$\gamma$ = unit weight	CPT = cone penetration test
$\gamma_{sat}$ = saturated unit weight	SCPT = seismic cone penetration test
CCR = coal combustion residuals	VST = vane shear test
SCS = Southern Company Services	ft-msl = feet above mean sea level (elevation)
GPC = Georgia Power Company	ft-bgs = feet below ground surface (depth)
	AP = ash pond





**SUBJECT: Geotechnical Material Property Package**  
**Project Number: 1777449**  
**Project Name: Plant McDonough Surface Impoundment Units AP-1, AP-2, and AP-3/4 Closure**  
**Prepared by: JGM** **Checked by: LJ / LS**  
**Date: Jul 2018** **Reviewed by: GLH**

### 3.0 CCR MATERIAL GEOTECHNICAL DESIGN PROPERTIES (PONDS 1, 3, & 4)

#### Objective

Develop geotechnical design parameters for the soils and Coal Combustion Residual (CCR) materials at AP-1 and AP-3 and AP-4 at GPC's Plant McDonough.

#### Lab Testing

Soil samples were collected via standard penetration testing (SPT) from October 26 through 29, 2015 and sent to Golder's geotechnical laboratory for analysis. Additional samples collected from SPT and fixed piston tube methods were collected during the January 2016 supplemental CCR investigations. Borings adjacent to the following CPTs were completed within the AP-3/4 area: CPT-18, -19, -30, and -36, PZ-02, and partial depth borings (CPT-28, 32, 33, and 39) in Dry Stack Investigation Area #1, and two partial depth borings (CPT-41 and 42) within Dry Stack Investigation Area #2 on Ash Pond #4.

Laboratory properties of CCR samples tested are summarized in the table below. Further laboratory information can be found in the attached documents.

Summary of Geotechnical Testing Data - Material Properties CCR (AP-3 & AP-4)					
Property	No. of Data Points	Min	Max	Avg	Med
Water Content (%)	12	21.4	82.8	43.0	42.9
Gravel (%)		0.0	3.2	0.4	0.0
Sand (%)		1.4	52.2	17.0	15.1
Fines (%)		44.6	98.6	83.0	84.9
Clay-Sized Particles (%)	8	8.0	30.0	19.1	16.8
Liquid Limit (LL) (%)	2 (10 NP)	33.5	35.6	34.5	--
Plastic Limit (PL) (%)		30.0	32.0	31.0	--
Plasticity Index (PI)		3.5	3.6	3.5	--
Max Dry Density (pcf)	2	85.0	87.4	86.2	--
Optimum Moisture (%)		23.8	26.6	25.2	--

#### Calculated & Measured Unit Weight

Saturated unit weight was calculated based on in-situ moisture content and specific gravity for six samples of sluiced CCR collected in borehole PZ-02 and was directly measured in two undisturbed Shelby tube samples collected in boreholes CPT-18 and CPT-19.

The water content of CCR samples taken below the water table and assumed saturated conditions were used to calculate saturated unit weights. From laboratory testing and Golder's extensive experience with CCR, a specific gravity between 2.15 was assumed for the calculations of samples for which specific gravity had not been directly measured. The formula below was used to calculate the saturated unit weights.

$$\gamma_{sat} (pcf) = [G_s * \left(\frac{1}{1 + G_s * w}\right)] * [62.4 * (1 + w)]$$



**SUBJECT: Geotechnical Material Property Package**  
**Project Number: 1777449**  
**Project Name: Plant McDonough Surface Impoundment Units AP-1, AP-2, and AP-3/4 Closure**  
**Prepared by: JGM** **Checked by: LJ / LS**  
**Date: Jul 2018** **Reviewed by: GLH**

Where:

- w = water content of sample
- G<sub>s</sub> = Specific gravity of ash solids (2.15 to 2.45)
- 62.4 pcf = unit weight of water

Using calculated unit weights, unit weights measured in undisturbed samples, and Golder's experience with CCR material, a total unit weight of 90 pcf was selected for sluiced CCR. A total unit weight of 110 pcf was selected for stacked CCR based on proctor test results and Golder's experience. A summary of the calculated and measured saturated unit weight ranges and a summary of selected unit weight values are listed below.

Summary of Calculated & measured Unit Weight Sluiced Ash					
Property	No. of Data Points	Min	Max	Avg	Med
Calc & Meas Sat Unit Weight (pcf)	8	88.2	108.0	98.0	98.1

Selected Representative Unit Weights (pcf)	
Uncompacted, Saturated	90
Stacked / Compacted, Saturated	110

### Strength Data

Strength parameters for CCR were evaluated based on Golder's in-situ investigation (CPT and BHs) and are summarized in the table below. Strength parameters were selected for AP-1, AP-3 and AP-4 for Sluiced and Stacked conditions. In AP-3 and AP-4, sluiced ash is identified as material deposited below an elevation of 840 ft-msl, or 6 feet below the dam crest elevation.

Unit weights and CPT strength data in the sluiced CCR show an increasing trend with regard to increased stress/depth below elevation 840. Strength trends in the sluiced ash do not appear to be affected by the weight of stacked ash on top of the sluiced ash. This independent behavior suggests a structure formed in the sluiced ash preventing stacked ash operations from consolidating the sluiced ash. That is, stresses imposed by the stacked ash were not large enough to affect the strength of the structured sluiced ash. Therefore, vane shear tests in the sluiced ash were normalized by vertical effective stresses calculated by neglecting the stacked ash material (material above elevation 840).

Drained friction angles of 24 and 30 degrees (Figures 1, 2 and 3) were selected for the Sluiced and Stacked CCR, respectively. The selected compacted CCR friction angle is based on the average correlated friction angle from CPT (33.5° and 35.2°, respectively for AP-3 and AP-4) and the lab test results from direct shear and triaxial testing (29-30 degrees). Peak strengths from lab testing indicate appropriate conservatism of the selected friction angle for stability analyses. For the drained condition and the vertical stress range tested, the CCR is best modeled without a cohesion parameter, according to the laboratory results, noting that apparent cohesion will exist due to capillarity in partially saturated samples.

An undrained strength represented with a friction angle of 12.4 degrees and cohesion of 0.05 tsf was selected for the sluiced CCR based on the lowest total strength envelope from CU test, correlated CPT values (Figure 4 and 5), and vane shear results. Frictional parameters were selected for the stacked CCR based on fitting the lower bound correlated undrained shear strength (from CPT) with depth (Figures 4 and 6). Friction angle of 24° and cohesion value of 0.18 tsf was selected.

In some cases, CCR is susceptible to liquefaction. For analyses requiring a post-liquefied or post-earthquake strength, a stress ratio ( $S_u/\sigma'_v$ ) of 0.08 with a minimum undrained shear strength of 0.05 tsf was selected based on Golder's experience.



**SUBJECT: Geotechnical Material Property Package**  
**Project Number: 1777449**  
**Project Name: Plant McDonough Surface Impoundment Units AP-1, AP-2, and AP-3/4 Closure**  
**Prepared by: JGM** **Checked by: LJ / LS**  
**Date: Jul 2018** **Reviewed by: GLH**

Summary of Geotechnical Strength Data						
AP-3 CCR- Stacked (Above Elev. 840 ft-msl)						
Property		No. of Data Points	Min	Max	Avg	Median
Drilling	SPT N (bpf)	-	-	-	-	-
	$\phi'$ (°) (Meyerhof)	-	-	-	-	-
	$\phi'$ (°) (Peck et al.)	-	-	-	-	-
CPT Interpreted	Peak $\phi'$ (°)	1536	22.4	>40	33.5	32.4
	Su (tsf)		0.12	>4	3.32	1.73
	SPT N <sub>60</sub> (bpf)		1	>100	20	12
	Norm. CPT Tip (Qtn)		3.3	385.3	50.6	25.0
AP-3 CCR - Sluiced (Below Elev. 840 ft-msl)						
Property		No. of Data Points	Min	Max	Avg	Median
Drilling	SPT N (bpf)	-	-	-	-	-
	$\phi'$ (°) (Meyerhof)	-	-	-	-	-
	$\phi'$ (°) (Peck et al.)	-	-	-	-	-
CPT Interpreted	Peak $\phi'$ (°)	881	15.6	>40	28.5	28.2
	Su (tsf)		0.06	>4	2.41	1.29
	SPT N <sub>60</sub> (bpf)		1	82	15	11
	Norm. CPT Tip (Qtn)		2.4	137.3	25.2	15.1
AP-4 CCR- Stacked (Above Elev. 840 ft-msl) - Before Closure (2016)						
Property		No. of Data Points (Borings)	Min	Max	Avg	Median
Drilling	SPT N (bpf)	11 (6)	2	12	4.5	4
	$\phi'$ (°) (Meyerhof)	-	28.3	35.5	30.0	30.0
	$\phi'$ (°) (Peck et al.)	-	27.3	30.6	28.0	28.0
	Peak Su/ $\sigma'_v$ - VST	2 (2)	0.87	0.89	0.88	0.88
	Residual Su/ $\sigma'_v$ - VST	2 (2)	0.30	0.72	0.51	0.51
CPT Interpreted	Peak $\phi'$ (°)	1899	24.1	>40	35.2	35.1
	Su (tsf)		0.21	>4	2.80	1.91
	SPT N <sub>60</sub> (bpf)		2	>100	18	13
	Norm. CPT Tip (Qtn)		4.8	754.5	58.7	38.9



**SUBJECT: Geotechnical Material Property Package**  
**Project Number: 1777449**  
**Project Name: Plant McDonough Surface Impoundment Units AP-1, AP-2, and AP-3/4 Closure**  
**Prepared by: JGM** **Checked by: LJ / LS**  
**Date: Jul 2018** **Reviewed by: GLH**

**AP-4 CCR - Sluiced (Below Elev. 840 ft-msl) - Before Closure (2016)**

<b>Property</b>		<b>No. of Data Points (Borings)</b>	<b>Min</b>	<b>Max</b>	<b>Avg</b>	<b>Median</b>
Drilling	<i>SPT N (bpf)</i>	10 (3)	0	2	1	0
	$\phi'$ (°) ( <i>Meyerhof</i> )	-	27.5	28.3	27.5	27.5
	$\phi'$ (°) ( <i>Peck et al.</i> )	-	27	27.3	27.0	27.0
	<i>Peak Su/σ'v - VST*</i>	28 (4)	0.23	4.33	0.98	0.73
	<i>Residual Su/σ'v - VST*</i>	28 (4)	0.03	0.50	0.21	0.20
CPT Interpreted	<i>Peak φ' (°)</i>	7471	13.2	>40	25.5	24.9
	<i>Su (tsf)</i>		0.03	>4	0.87	0.54
	<i>SPT N<sub>60</sub> (bpf)</i>		1	>100	7	6
	<i>Norm. CPT Tip (Qtn)</i>		1.4	268.0	11.8	7.6

\* Vertical effective stress measured from elevation 840.

**AP-4 CCR - Sluiced (Below Elev. 840 ft-msl) - During Closure (2017-2018)**


<b>Property</b>		<b>No. of Data Points (Borings)</b>	<b>Min</b>	<b>Max</b>	<b>Avg</b>	<b>Median</b>
CPT Interpreted	<i>Peak φ' (°)</i>	7869	7.8	>40	26.8	24.9
	<i>Su (tsf)</i>		0.01	>4	0.67	0.37
	<i>SPT N<sub>60</sub> (bpf)</i>		0	41	7	6
	<i>Norm. CPT Tip (Qtn)</i>		0.1	108.5	9.0	6.4

**Stacked / Compacted CCR**

<b>Lab Test</b>	<b>Strength Type</b>	<b>φ (deg)</b>	<b>c (tsf)</b>
Direct Shear CPT-32-AP4 5-10 ft	<i>Peak Effective</i>	29.1	0
	<i>Post-Peak Effective</i>	29.1	0
Direct Shear CPT-39-AP4 9-10.5 ft	<i>Peak Effective</i>	30.4	0
	<i>Post-Peak Effective</i>	30.0	0

**Sluiced CCR**

<b>Lab Test</b>	<b>Strength Type</b>	<b>φ (deg)</b>	<b>c (tsf)</b>
CU Triaxial BH-CPT-18-AP4 35-37 ft	<i>Peak Effective</i>	28.8	0.00
	<i>Peak Total</i>	10.8	0.22
CU Triaxial BH-CPT-19-AP4 35-37 ft	<i>Peak Effective</i>	28.4	0.00
	<i>Peak Total</i>	19.9	0.31

	<b>SUBJECT: Geotechnical Material Property Package</b> <b>Project Number: 1777449</b> <b>Project Name: Plant McDonough Surface Impoundment Units AP-1, AP-2, and AP-3/4 Closure</b>		
	<b>Prepared by: JGM</b> <b>Date: Jul 2018</b>		<b>Checked by: LJ / LS</b> <b>Reviewed by: GLH</b>

Summary of Selected Strength Parameters for CCR Materials				
CCR Material	Drained		Undrained	
	$\phi'$ (deg)	$c'$ (psf)	$\phi$ (deg)	Su (tsf) (or $c'$ )
Sluiced CCR	24	0	12.4	0.05
Post Liquefied CCR	---	---	Su/ $\sigma'_{vo}$ = 0.08 (min 100 psf)	
Stacked CCR	30	0	24	0.18
Compacted CCR	30	0	24	0.18

#### 4.0 FILL SOILS GEOTECHNICAL DESIGN PROPERTIES (PONDS 1, 2, 3, & 4)

##### Objective

Develop strength parameters for existing embankment fill materials in the vicinity of AP-1, AP-3 and AP-4.

##### Lab Testing

Soil samples were collected via standard penetration testing (SPT) from October 26 through 29, 2015 and sent to Golder's geotechnical laboratory for analysis. Two borings (CPT-46 and 49) were drilled within the embankment of AP-4 to depths of 50 and 45 ft-bgs, respectively.

Laboratory properties of fill soil samples collected during SPT are summarized in the table below.

Summary of Geotechnical Testing Data					Basic
Properties Fill					
Property	No. of Data Points	Min	Max	Avg	Med
Water Content (%)	4	16.1	20.9	18.9	18.7
Gravel (%)		1.9	7.7	3.5	4.1
Sand (%)		37.9	46.0	43.9	43.0
Fines (%)		49.5	58.4	51.9	52.9
Liquid Limit (LL) (%)		33.1	45.0	39.1	39.2
Plastic Limit (PL) (%)		25.0	29.0	28.0	29.0
Plasticity Index (PI)		4.1	16.0	11.1	12.2
Max Dry Density (pcf)	2	110.6	113.2	111.9	--
Optimum Moisture (%)		14.4	15.1	14.75	--

#### Strength Correlations for Fine-Grained Material

##### Strength Data

Strength parameters for the fill soils were evaluated based on in-situ and laboratory testing, summarized in the table below.

The drained strength appears to decrease with depth to approximately 820 feet, where the trend becomes less prevalent (Figure 7). The correlated effective friction angle varies from approximately 45 to 30° with an average value of 34.1°. A lower bound drained effective friction angle of 30° and cohesion of 50 psf were selected based on laboratory and in-situ testing. These values are based on CPT correlation (Figure 7), laboratory testing, and plasticity correlations. Undrained strengths (Su) vary less with depth than drained strengths (Figure 8). An undrained strength of 1.0 tsf was selected. The CPT correlation is not valid for Su > 4 tsf; these values are excluded from Figure 8.



**SUBJECT: Geotechnical Material Property Package**  
**Project Number: 1777449**  
**Project Name: Plant McDonough Surface Impoundment Units AP-1, AP-2, and AP-3/4 Closure**  
**Prepared by: JGM** **Checked by: LJ / LS**  
**Date: Jul 2018** **Reviewed by: GLH**

**Summary of Geotechnical Strength Data**  
**Fill Soils**

Property		No. of Data Points	Min	Max	Avg	Median
<b>Fill Soils</b>						
Drilling	SPT N (bpf)	14	7	28	12	--
	$\phi'$ (°) (Meyerhof)		32.5	39.5	35.5	--
	$\phi'$ (°) (Peck et al.)		29.0	35.4	30.6	--
CPT Interpreted	Peak $\phi'$ (°)	2130	17.2	>40	34.1	34.5
	Su (tsf)		0.2	>4	3.7	3.4
	SPT N <sub>60</sub> (bpf)		4	>100	35	33
	Norm. CPT Tip (Qtn)		0.9	455	49.7	32.9

Correlations from Terzaghi et al. (1996) can be used to estimate friction angles of cohesive soils using laboratory data of plasticity index (PI). NAVFAC Design Manual 7.02 also gives estimated correlations for effective friction angle for various fine-grained material, as referenced in the table below.

For PI < 100:  $\phi' = 0.0013(PI)^2 - 0.2717(PI) + 35.876$   $R^2 = 0.9972$  (Terzaghi et al., 1996)

**Calculated Strength Based on Plasticity (mean PI = 11)**

Cohesive Soil Peak Friction Angle		
<b>Terzaghi et al. Correlations</b>	Friction Angle (deg), $(\phi'_{fs})_{tan}$	33.0

Other relations can also be used to estimate the fully-softened strength of fine-grained materials, such as that presented by Mesri and Shahien (2003), using plasticity index (see attached Figure 9).

**Calculated Strength Based on Plasticity (mean PI = 11)**

Fully Softened		
<b>Mesri and Shahien Correlations</b>	Cohesion, c' (psf)	104.0
	Friction Angle (deg), $(\phi'_{fs})_{tan}$	29.5

**Summary of Selected Strength Parameters for Fill Soils**

Material	Drained		Undrained
	$\phi'$ (deg)	c' (psf)	Su (tsf)
Fill Soils	30	100	1.0

**Selected Total Unit Weight (pcf)**

Fill Soils	125
------------	-----



**SUBJECT: Geotechnical Material Property Package**  
**Project Number: 1777449**  
**Project Name: Plant McDonough Surface Impoundment Units AP-1, AP-2, and AP-3/4 Closure**  
**Prepared by: JGM** **Checked by: LJ / LS**  
**Date: Jul 2018** **Reviewed by: GLH**

## 5.0 RESIDUAL SOILS GEOTECHNICAL DESIGN PROPERTIES (AP-1, AP-2, AP-3, and AP-4)

### Objective

Develop strength parameters for fill material in the vicinity of AP-1, AP-2, AP-3, and AP-4.

### All Ash Ponds

Basic properties for the Residuum were evaluated based on laboratory testing and CPT correlations and are summarized in the table below.

For stability and settlement analyses, a unit weight of 125 pcf was selected for the residuum. This selection is based on proctor tests, CPT correlations, and Golder's past experience with residual soils.

Other laboratory tests used to determine strength properties are described below.

Summary of Geotechnical Testing Data						
Basic Properties Residuum						
Property		No. Tests	Min	Max	Avg	Med
<b>Primary Laboratory Tests</b>						
Depth Range (ft)		-	84.2	114.5	99.3	99.3
Water Content (%)		2	7	28	17	17
Gravel (> 4.75 mm) (%)		1	2	2	2	2
Sand (%)		1	39	39	39	39
Fines (< 0.075 mm) (%)		1	59	59	59	59
Liquid Limit (LL) (%)		1	43	2	2	2
Plastic Limit (PL) (%)		1	28	28	28	28
Plasticity Index (PI)		1	15	15	15	15
Non Plastic Results		0	0 of 1			
Unit Weight (pcf)	CPT interpreted	2130	97	140	125	126

### CPT Interpreted Data

Strength parameters for the residuum were evaluated based on in-situ and laboratory testing, summarized in the table below. The residual soils were broken into upper and lower residuum.

A drained friction angle of 30° with a cohesion of 50 psf was selected for the residuum material, both upper and lower. These values are based on in-situ testing (CPT and SPT correlation) and plasticity correlation from laboratory tests. Strength correlations are plotted in Figure 10.

Undrained shear strengths of 0.5 tsf and 1.5 tsf were selected for upper and lower residuum, respectively (Figure 11). These values are based on correlated CPT data and Golder's extensive experience with residual soils.



**SUBJECT: Geotechnical Material Property Package**  
**Project Number: 1777449**  
**Project Name: Plant McDonough Surface Impoundment Units AP-1, AP-2, and AP-3/4 Closure**  
**Prepared by: JGM** **Checked by: LJ / LS**  
**Date: Jul 2018** **Reviewed by: GLH**

**Summary of Geotechnical Strength Data  
Upper Residuum**

Property		No. of Data Points (Borings)	Min	Max	Avg	Median
<b>Residual Soils</b>						
Drilling	SPT N (bpf)	7	5	26	12	10
	$\phi'$ (°) (Meyerhof)		30.8	39.0	35.5	35.0
	$\phi'$ (°) (Peck et al.)		28.3	34.8	30.6	30.0
CPT Interpreted	Peak $\phi'$ (°)	2172	16.0	>40	30.1	30.1
	Su (tsf)		0.1	>4	2.5	2.2
	SPT N60 (bpf)		3	>100	22	21
	Qtn		0.7	177.3	19.6	13.6

**Summary of Geotechnical Strength Data  
Lower Residuum**

Property		No. of Data Points (Borings)	Min	Max	Avg	Median
<b>Residual Soils</b>						
Drilling	SPT N (bpf)	7	5	26	12	10
	$\phi'$ (°) (Meyerhof)		30.8	39.0	35.5	35.0
	$\phi'$ (°) (Peck et al.)		28.3	34.8	30.6	30.0
CPT Interpreted	Peak $\phi'$ (°)	1975	19.0	>40	35.4	36.1
	Su (tsf)		0.2	>4	>4	>4
	SPT N60 (bpf)		2.9	>100	43	33.7
	Qtn		1.3	281.6	43.5	31.7

**Summary of Selected Strength Parameters for Residual Soils**

Material	Drained		Undrained
	$\phi'$ (deg)	c' (psf)	
Upper Residuum	30	50	Su/ $\sigma'_{v0}$ = 0.65
Lower Residuum	30	100	Su = 1.5 tsf

**Selected Total Unit Weight (pcf)**

Residuum	125
----------	-----





**SUBJECT: Geotechnical Material Property Package**  
**Project Number: 1777449**  
**Project Name: Plant McDonough Surface Impoundment Units AP-1, AP-2, and AP-3/4 Closure**  
**Prepared by: JGM** **Checked by: LJ / LS**  
**Date: Jul 2018** **Reviewed by: GLH**

### 6.0 ALLUVIUM (POND 1)

Based on borehole data provided in AMEC's 2010 report, alluvial soils exist along the southern portion of the AP-1 dikes. This material was categorized as a low plasticity clay with trace organics and some sandy pockets in drilling logs provided in AMEC's report. Blow counts in this soil were generally found to be around five blows per foot, and the consistency was noted as medium stiff. Golder modeled this soil with the strength parameters shown in the table below base on local experience with similar materials.

Summary of Selected Strength Parameters for Alluvial Soils				
Material	Unit Weight (pcf)	Drained		Undrained
		$\phi'$ (deg)	c' (psf)	Su (tsf)
Alluvial Soil	115	28	50	0.5

### 7.0 SUMMARY OF ESTIMATED PROPERTIES

Representative material properties, as shown in table below, have been selected for use in slope stability analysis of temporary (during construction), final (long-term, steady state), and post-liquefaction conditions.

As stated in Section 2.0, strength parameters are based on a combination of CPT-based correlations for peak effective friction angle, borehole blow count data, vane shear data, laboratory shear strength test results, plasticity correlations for fully-softened shear strength, and Golder's experience.

Selected Strength Parameters							
Material	Total Unit Weight (pcf)	Drained Strength		Undrained Strength		Post-Earthquake Strength	
		$\phi'$ (deg)	c' (psf)	$\phi$ (deg)	c (tsf)	$\phi$ (deg)	c (tsf)
Sluiced CCR Above GW Below GW	90	24	0	12	0.05	24	0
						Su/ $\sigma'_{vo}$ = 0.08 (min 100 psf)	
Stacked / Compacted CCR	110	30	0	24	0.18	30	0
Fill Soils	125	30	100	Su = 1.0 tsf		30	100
Upper Residuuum	125	30	50	Su/ $\sigma'_{vo}$ = 0.65		30	50
Lower Residuuum	125	30	100	Su = 1.5 tsf		30	100
Alluvium	115	28	50	Su = 0.5 tsf		28	50



**SUBJECT: Geotechnical Material Property Package**  
**Project Number: 1777449**  
**Project Name: Plant McDonough Surface Impoundment Units AP-1, AP-2, and AP-3/4 Closure**  
**Prepared by: JGM** **Checked by: LJ / LS**  
**Date: Jul 2018** **Reviewed by: GLH**

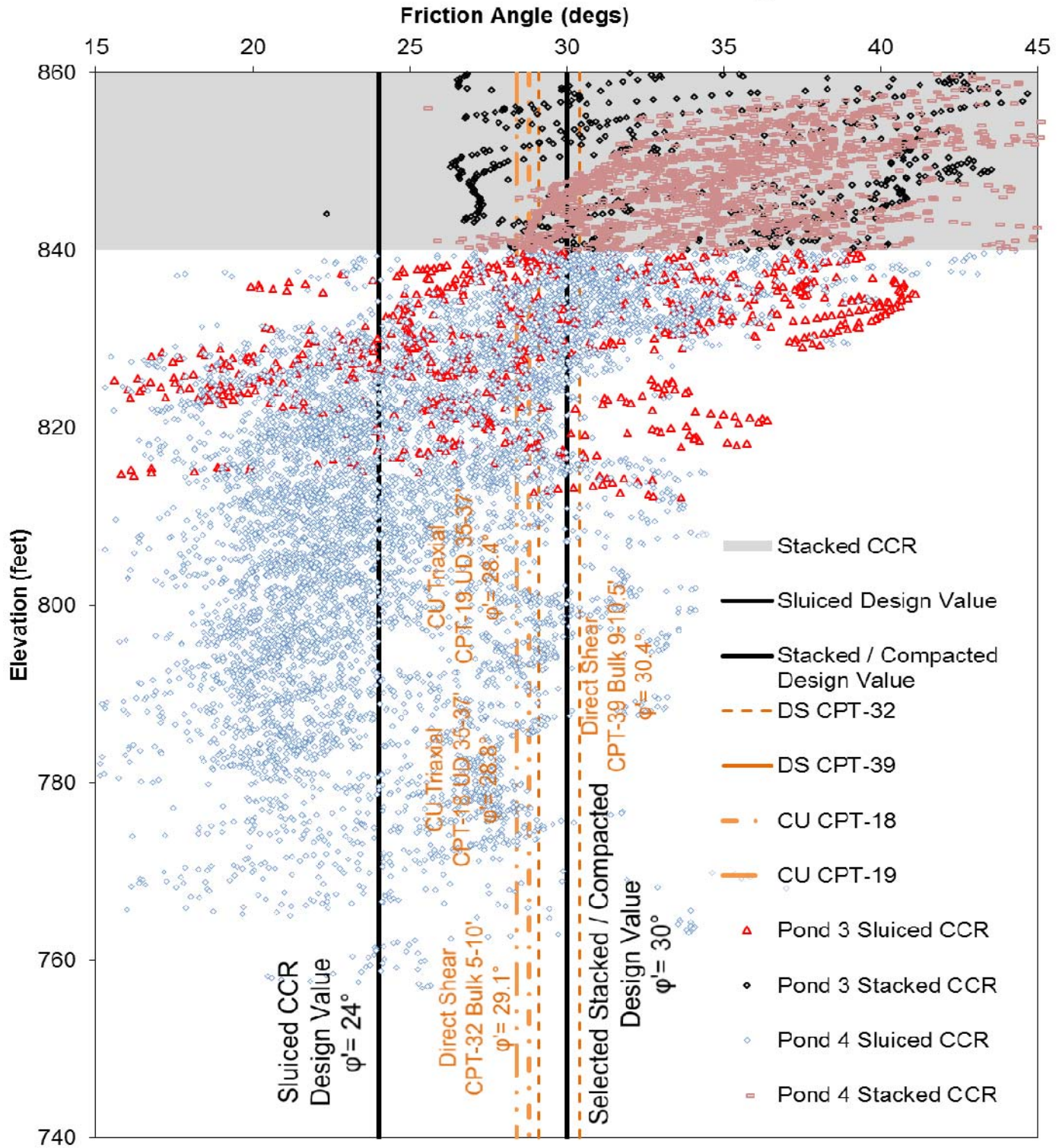
## 8.0 ATTACHMENTS


- 1 - Lab Data Summary
- 2 - CPT Data Summary From Field Investigation
- 3 - Boring Logs From Field Investigation

## 9.0 REFERENCES

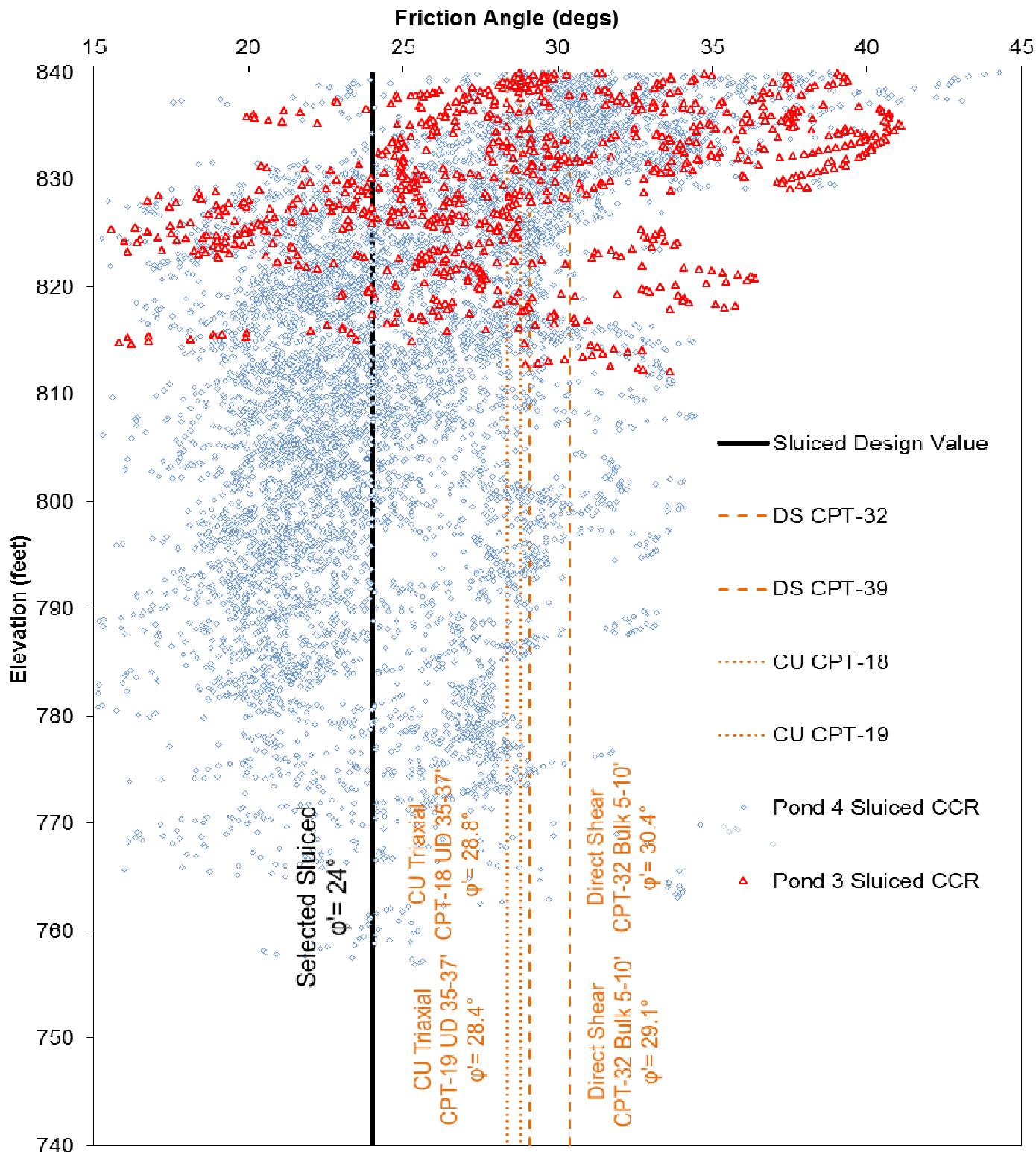
- AMEC (2010). "Report of Dam Safety Assessment of Coal Combustion Surface Impoundments Plant McDonough, Smyrna, GA." December 2010
- CONETEC (2014), "Cone Penetration Testing Interpretation Methods"
- FHWA (1998), Training Course in Geotechnical and Foundation Engineering - Rock Slopes, Publication No. FHWA HI-99-007
- Golder Associates 2016, MCD15017-TM011 - AP3\_and\_4 Seismic Hazard and Liquefaction Calculation Package\_23Dec2015
- Golder Associates 2018, AP-3/4 CPT Data during Closure
- Gregg Drilling, "Guide to Cone Penetration Testing", 6th Edition 2015.
- Kulhawy, F. H. and Mayne, P.W. (1990). Manual on Estimating Soil Properties for Foundation Design, EL-6800, Electric Power Research Institute (EPRI).
- Lunne, T., Robertson, P.K. and Powell, J. J. M., 1997, "Cone Penetration Testing in Geotechnical Practice," Blackie Academic and Professional.
- Mayne, P.W. (2014). KN2: "Interpretation of geotechnical parameters from seismic piezocone tests". Proceedings, 3rd International Symposium on Cone Penetration Testing (CPT'14, Las Vegas) p 47-73.
- Mesri, G. and Shahien, M. (2003) "Residual Shear Strength Mobilized in First-Time Slope Failures," JGGE, 129, 1, 12-31.
- Naval Facilities Engineering Command (NAVFAC) (1986). Design Manual 7.02 Foundations and Earth Structures.
- Terzaghi, K., Peck, R.B., Mesri, G. (1996). Soil Mechanics in Engineering Practice, 3rd Edition, John Wiley & Sons, New York. Figure 19.7
- Robertson, P.K. 2009. "Interpretation of cone penetration tests – a unified approach". Canadian Geotechnical Journal 49 (11): 1337-1355.


# CPT Based CCR Effective Friction Angle



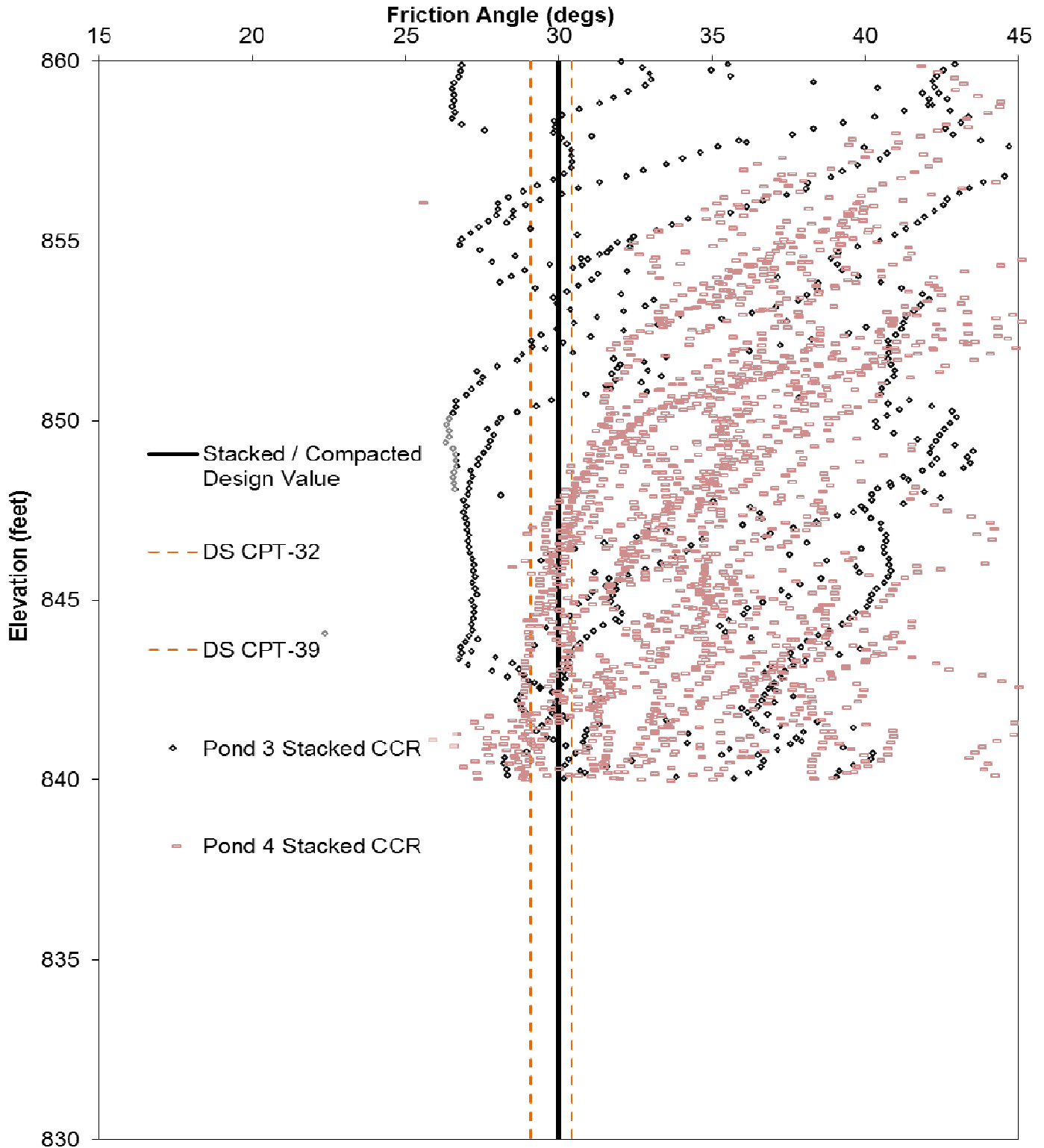
 <b>GOLDER</b> Golder Associates Inc.	SCALE	AS SHOWN	<b>Peak Friction Angle Based On CPT Correlation and Lab Results (Direct Shear &amp; Triaxial)</b>  <b>Correlation Developed By Mayne And Kulhawy 1996</b>		
	DATE	Apr 2016			
DESIGN					
DRAWN	WRP				
CHECK	TPC				
PROJECT No.	1539180	REV.	1	REVIEW	GLH

# CPT Based Sluiced CCR Effective Friction Angle



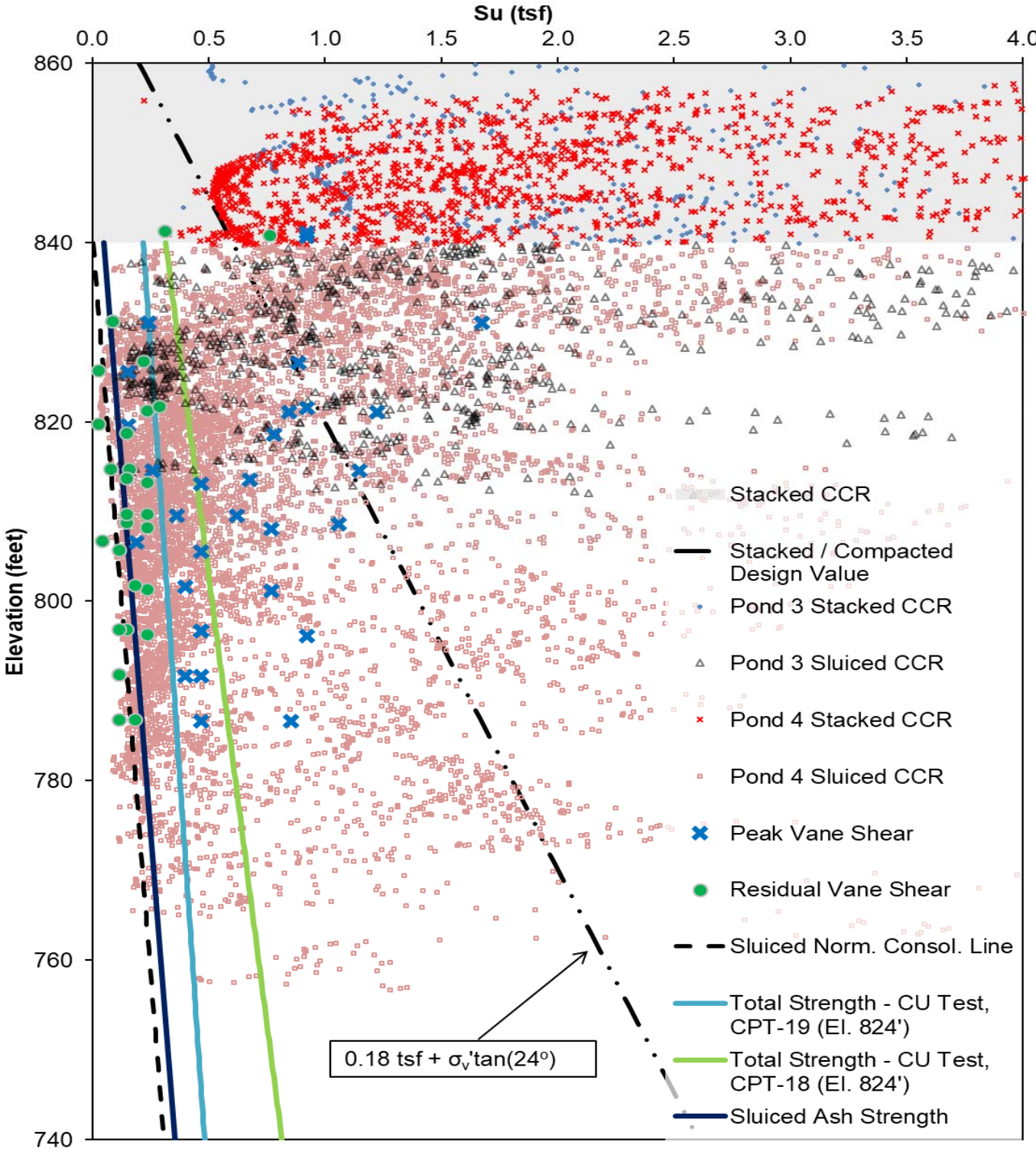
 <p><b>GOLDER</b></p> <p>Golder Associates Inc.</p>	SCALE	AS SHOWN	<p><b>Peak Friction Angle Based On CPT Correlation and Lab Results (Direct Shear)</b></p> <p><b>Correlation Developed By Mayne And Kulhawy 1996</b></p>
	DATE	Dec 2015	
	DESIGN		
	DRAWN	WRP	
Figure 2	CHECK	TPC	
PROJECT No. 1539180	REV. 0	REVIEW	GLH

# CPT Based Stacked CCR Effective Friction Angle



 <b>GOLDER</b> <small>Golder Associates Inc.</small>	SCALE AS SHOWN		<b>Peak Friction Angle Based On CPT Correlation and Lab Results (Direct Shear)</b>  <b>Correlation Developed By Mayne And Kulhawy 1996</b>
	DATE Apr 2016		
	DESIGN		
	DRAWN WRP		
	CHECK TPC		
Figure 3			
PROJECT No. 1539180	REV. 1	REVIEW GLH	

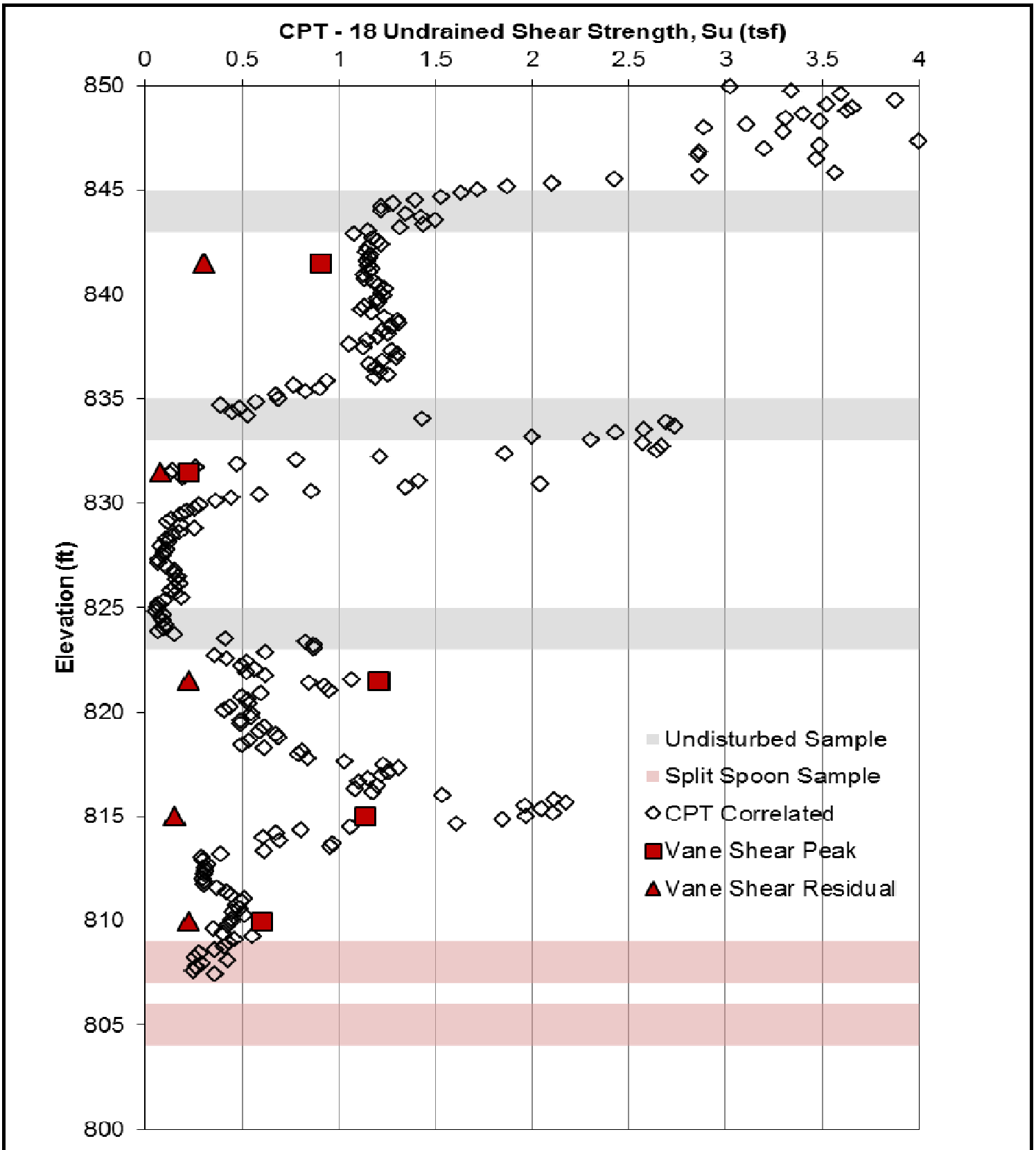
# CCR Undrained Shear Strength (Su)




<p style="font-size: 24px; font-weight: bold; margin: 0;">GOLDER</p> <p style="font-size: 10px; margin: 0;">Golder Associates Inc.</p>	SCALE AS SHOWN	
	DATE Jul 2018	
	DESIGN -	
	DRAWN WRP	
	CHECK JGM	
PROJECT No.	1539180	REV. 1
		REVIEW GLH

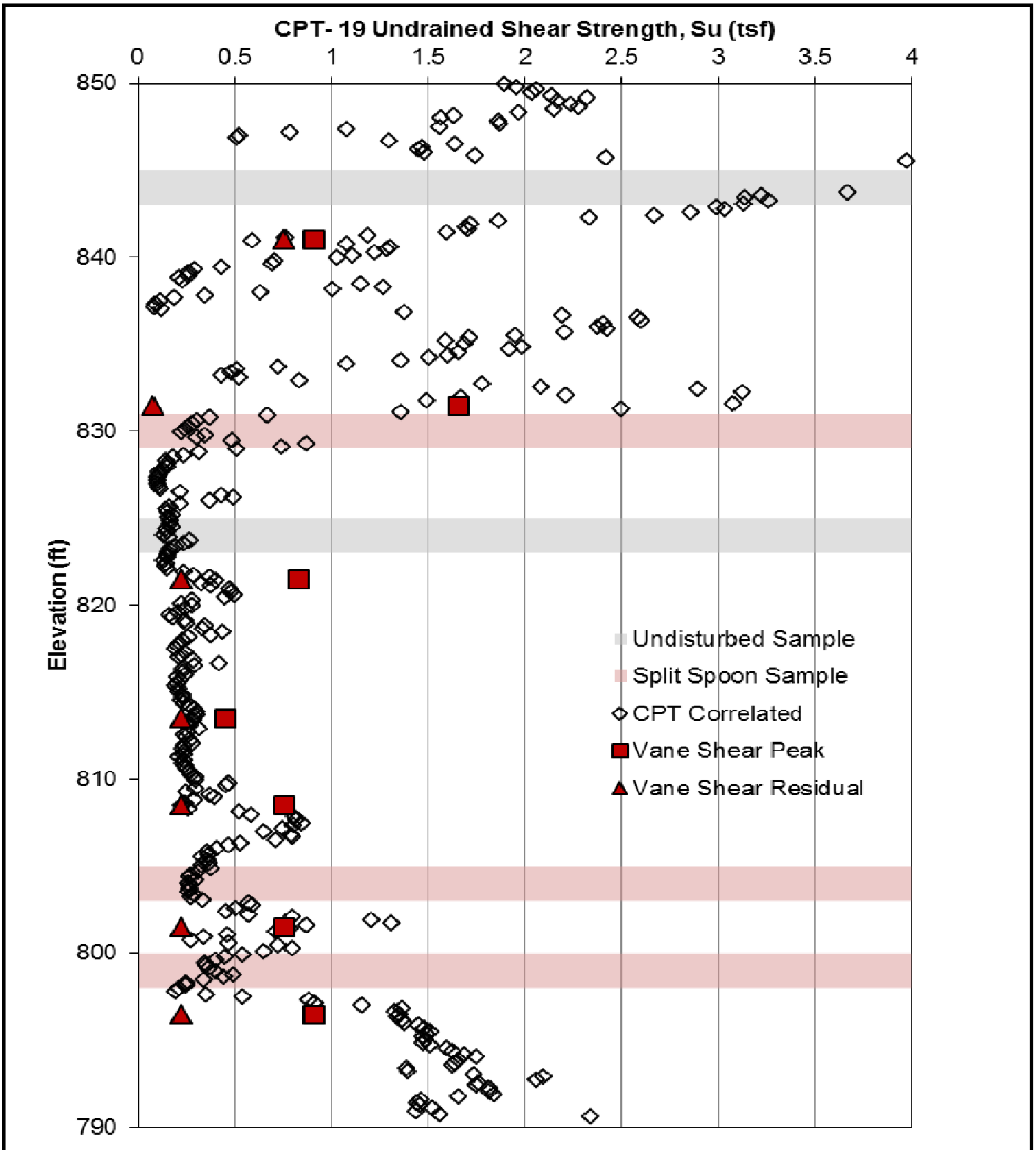
Measured and Correlated Undrained Shear Strengths


CPT Correlation Based On Robertson et al. 1986 and Lunne et al. 1996



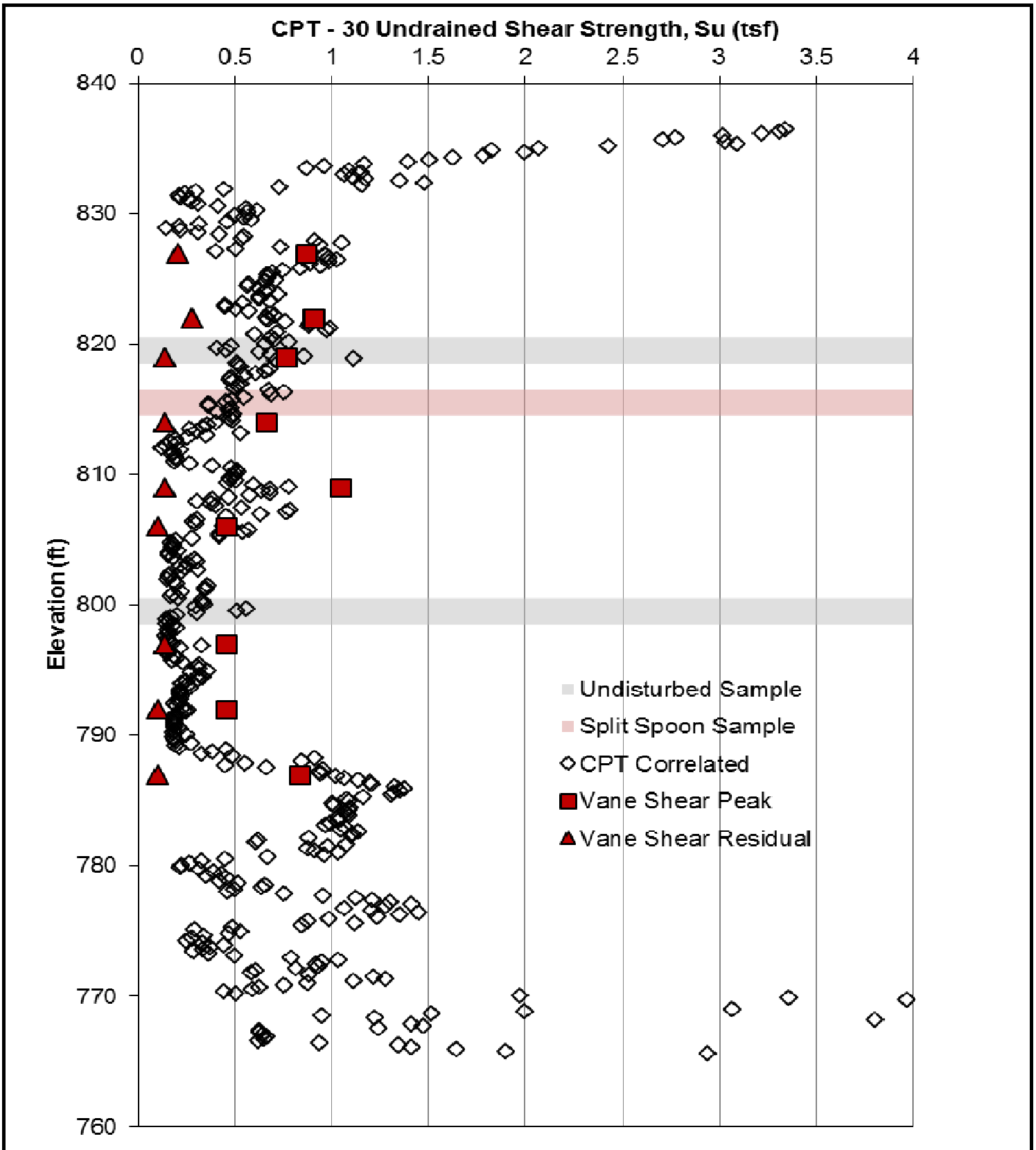
 <b>GOLDER</b> Golder Associates Inc.	SCALE	AS SHOWN
	DATE	Apr 2016
	DESIGN	-
	DRAWN	WRP
	CHECK	JGM
PROJECT No.	1539180	REV. 1
		REVIEW GLH


**Measured and Correlated  
 Undrained Shear Strengths at CPT-18**  
  
**CPT Correlation Based On  
 Robertson et al. 1986 and Lunne et al. 1996**

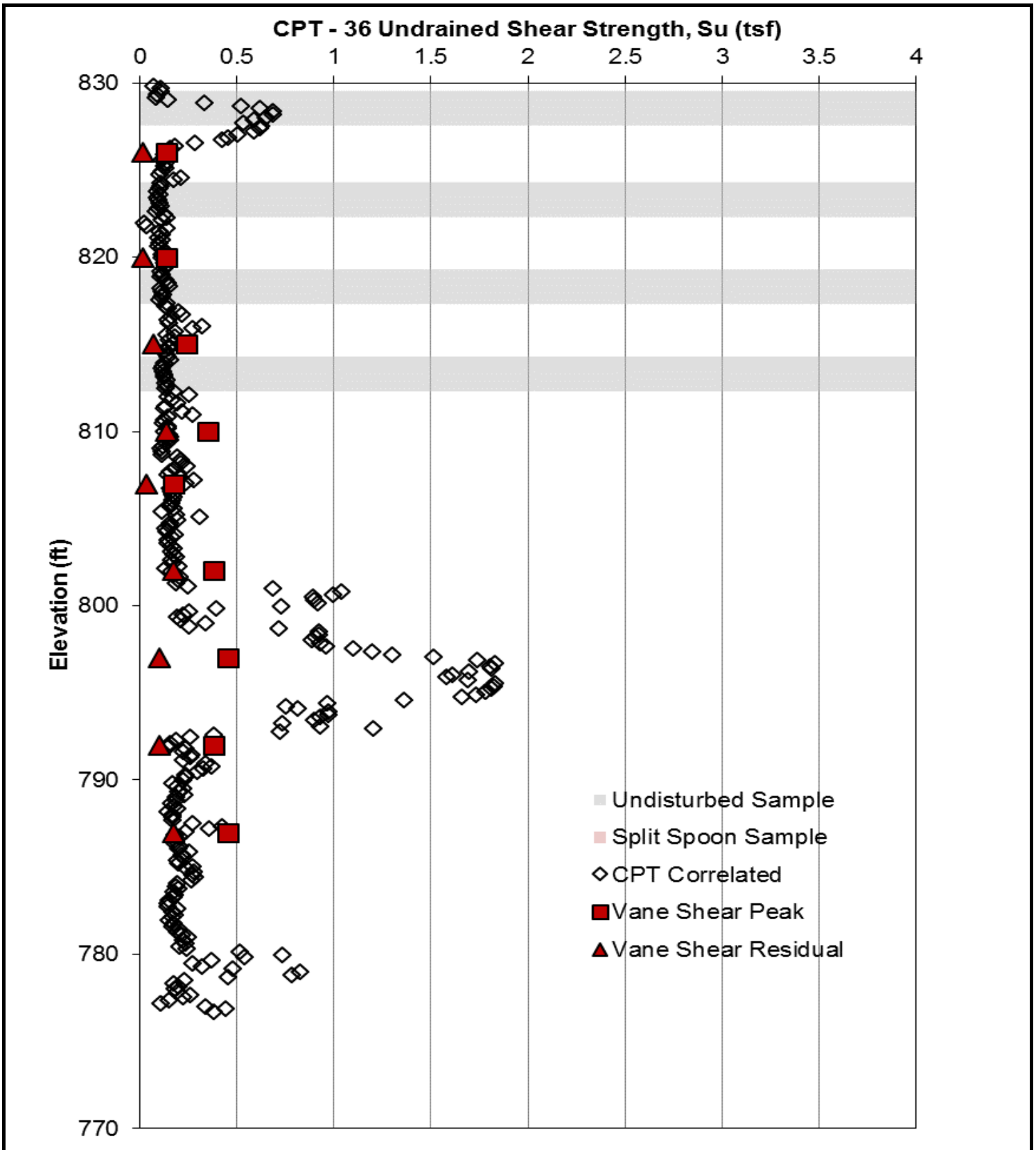



 <b>GOLDER</b> Golder Associates Inc.	SCALE	AS SHOWN	<b>Measured and Correlated Undrained Shear Strengths at CPT-19</b>  <b>CPT Correlation Based On Robertson et al. 1986 and Lunne et al. 1996</b>		
	DATE	Apr 2016			
DESIGN	-				
DRAWN	WRP				
CHECK	JGM				
PROJECT No.	1539180	REV.	1	REVIEW	GLH



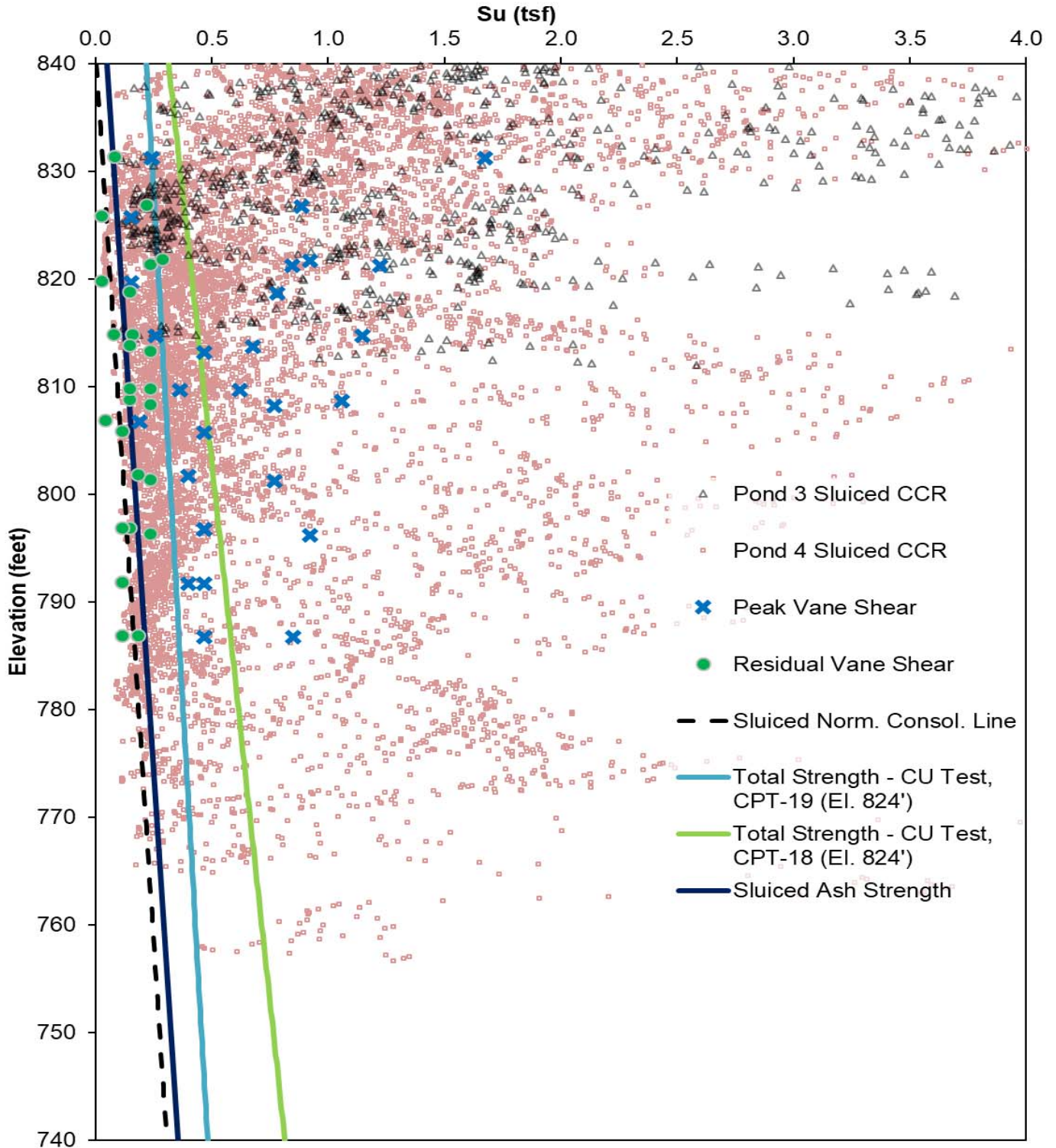



 <p>Golder Associates Inc.</p>	SCALE AS SHOWN		<p><b>Measured and Correlated Undrained Shear Strengths at CPT-30</b></p> <p><b>CPT Correlation Based On Robertson et al. 1986 and Lunne et al. 1996</b></p>
	DATE Apr 2016		
	DESIGN -		
	DRAWN WRP		
	CHECK JGM		
Figure 4d			
PROJECT No. 1539180	REV. 1	REVIEW GLH	



 <b>GOLDER</b> Golder Associates Inc.	SCALE	AS SHOWN	<b>Measured and Correlated Undrained Shear Strengths at CPT-36</b>  <b>CPT Correlation Based On Robertson et al. 1986 and Lunne et al. 1996</b>		
	DATE	Apr 2016			
DESIGN	-				
DRAWN	WRP				
CHECK	JGM				
PROJECT No.	1539180	REV.	1	REVIEW	GLH

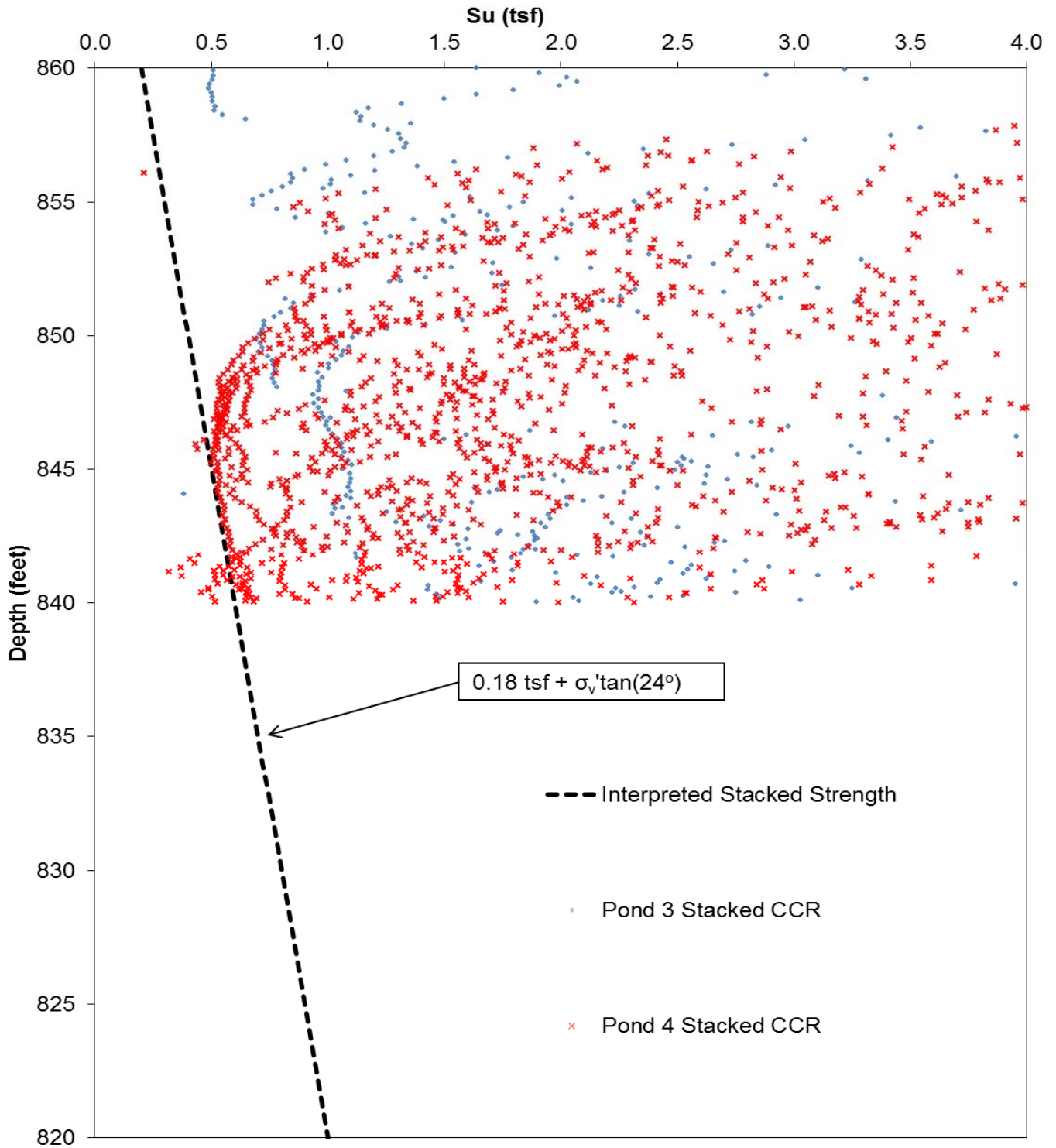
# CPT Based Sluiced CCR Undrained Shear Strength (Su)



 <b>GOLDER</b> Golder Associates Inc.	SCALE	AS SHOWN
	DATE	Jul 2018
Figure 5 PROJECT No. 1539180	DESIGN	
	DRAWN	WRP
	CHECK	TPC
REV. 1	REVIEW	GLH

**Undrained Shear Strength Based On CPT Correlation**  
**Correlation Based On Robertson et al. 1986 and Lunne et al. 1996**

# CPT Based Stacked CCR Undrained Shear Strength (Su)



Golder Associates Inc.

SCALE	AS SHOWN
DATE	Dec 2015
DESIGN	
DRAWN	WRP
CHECK	TPC
REVIEW	GLH

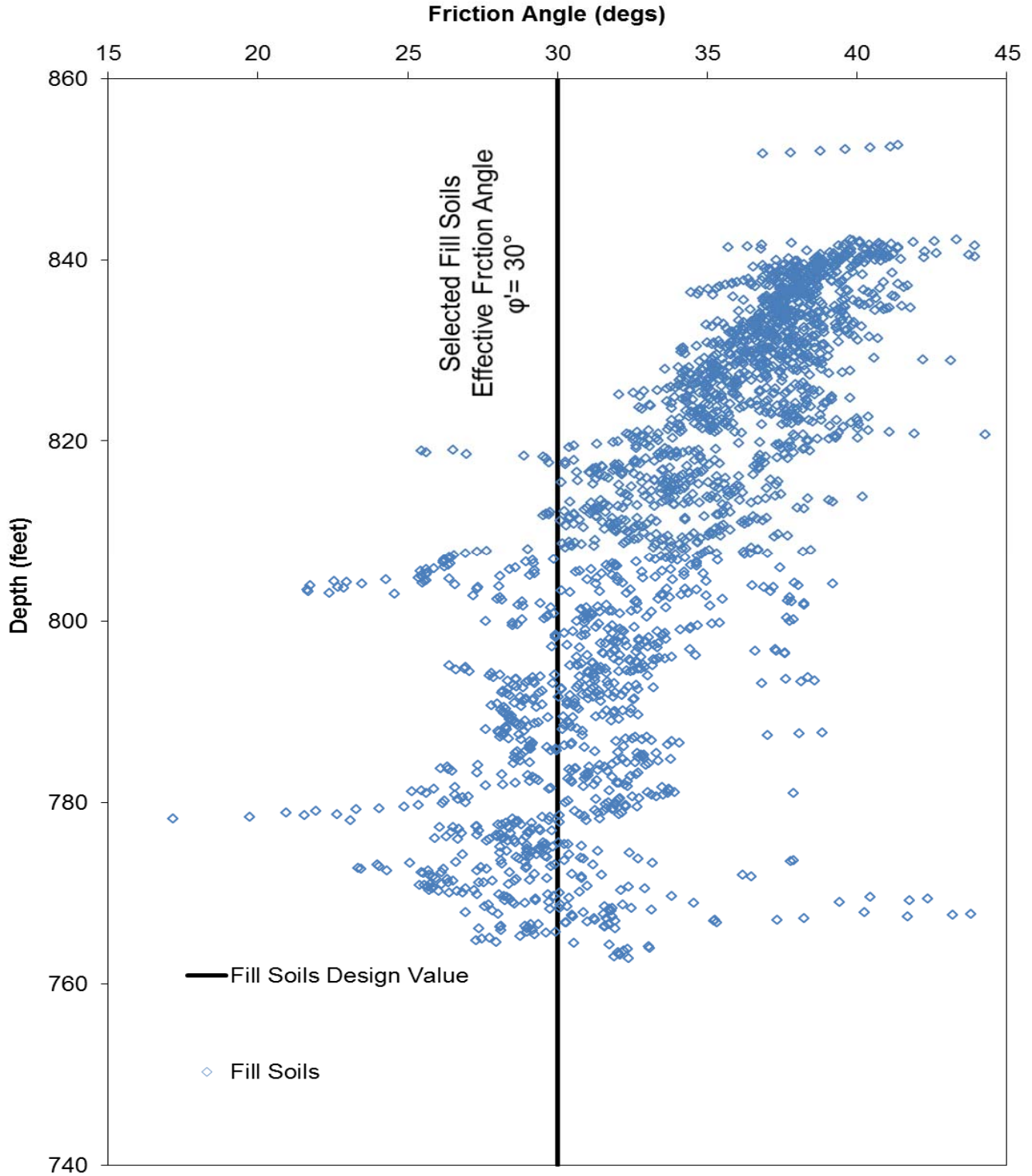
**Undrained Shear Strength Based On CPT Correlation**


**Correlation Based On Robertson et al. 1986 and Lunne et al. 1996**

Figure 6

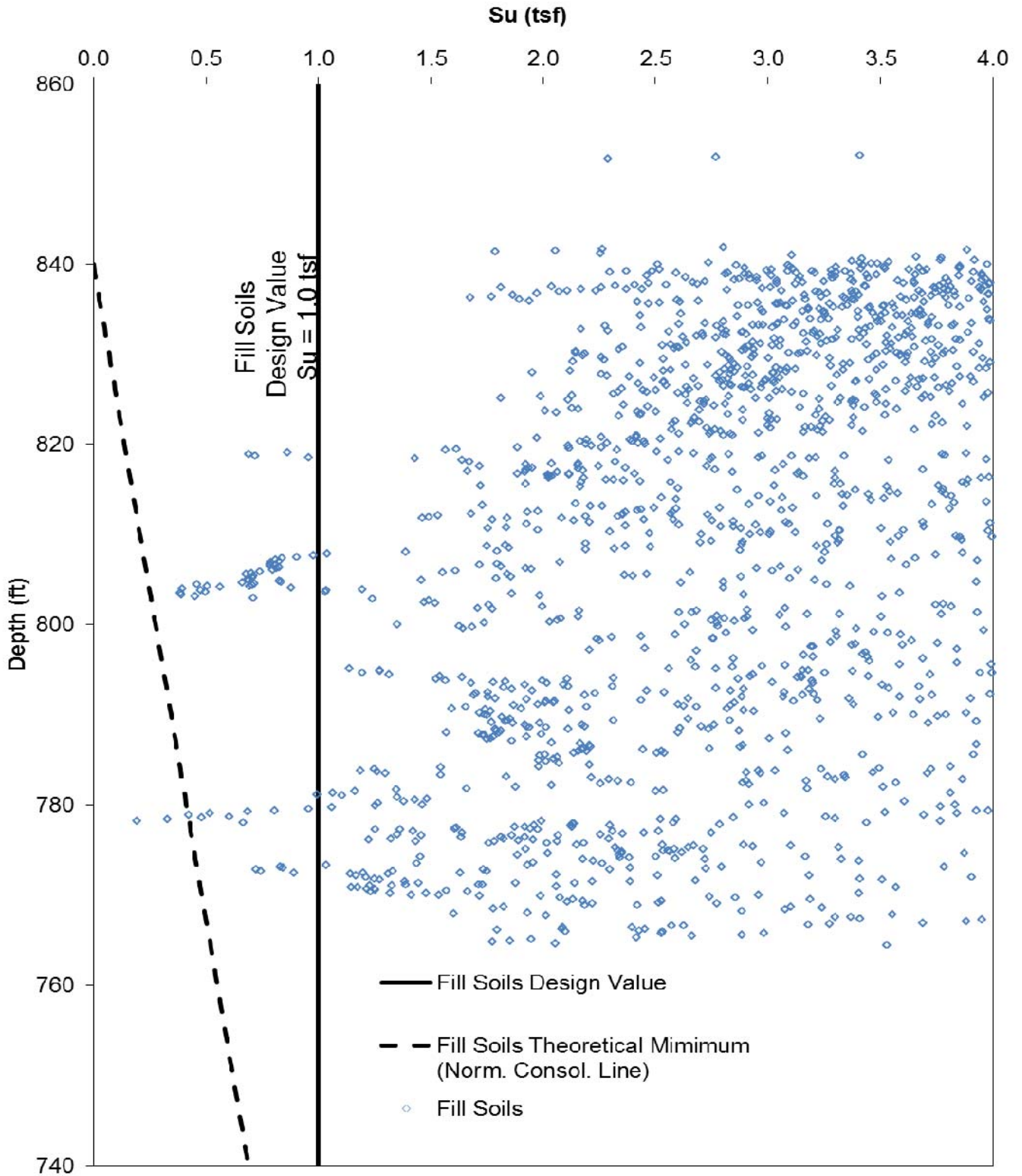
PROJECT No.	1539180	REV.	0
-------------	---------	------	---

# CPT Based Fill Soils Effective Friction Angle



 <p>Golder Associates Inc.</p>	SCALE	AS SHOWN	<p><b>Peak Friction Angle Based On CPT Correlation and Lab Results (Direct Shear)</b></p> <p><b>Correlation Developed By Mayne And Kulhawy 1996</b></p>		
	DATE	Dec 2015			
	DESIGN				
	DRAWN	WRP			
	CHECK	TPC			
PROJECT No.	1539180	REV.	0	REVIEW	GLH

# CPT Based Fill Soils Undrained Shear Strength



**GOLDER**

Golder Associates Inc.

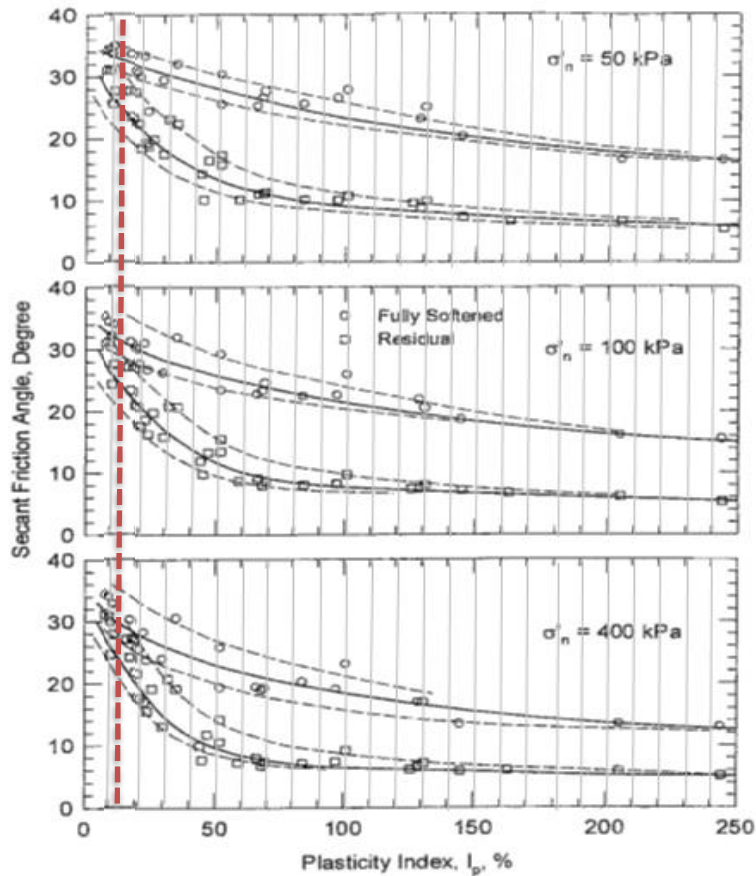
SCALE	AS SHOWN
DATE	Dec 2015
DESIGN	
DRAWN	WRP
CHECK	TPC
REVIEW	GLH

**Undrained Shear Strength Based On CPT  
Correlation**

**Correlation Based On Robertson et al. 1986  
and Lunne et al. 1996**

Figure 8

PROJECT No.	1539180	REV.	0
-------------	---------	------	---




Note - Vertical Lines on Figure are Approximate and Not on Original

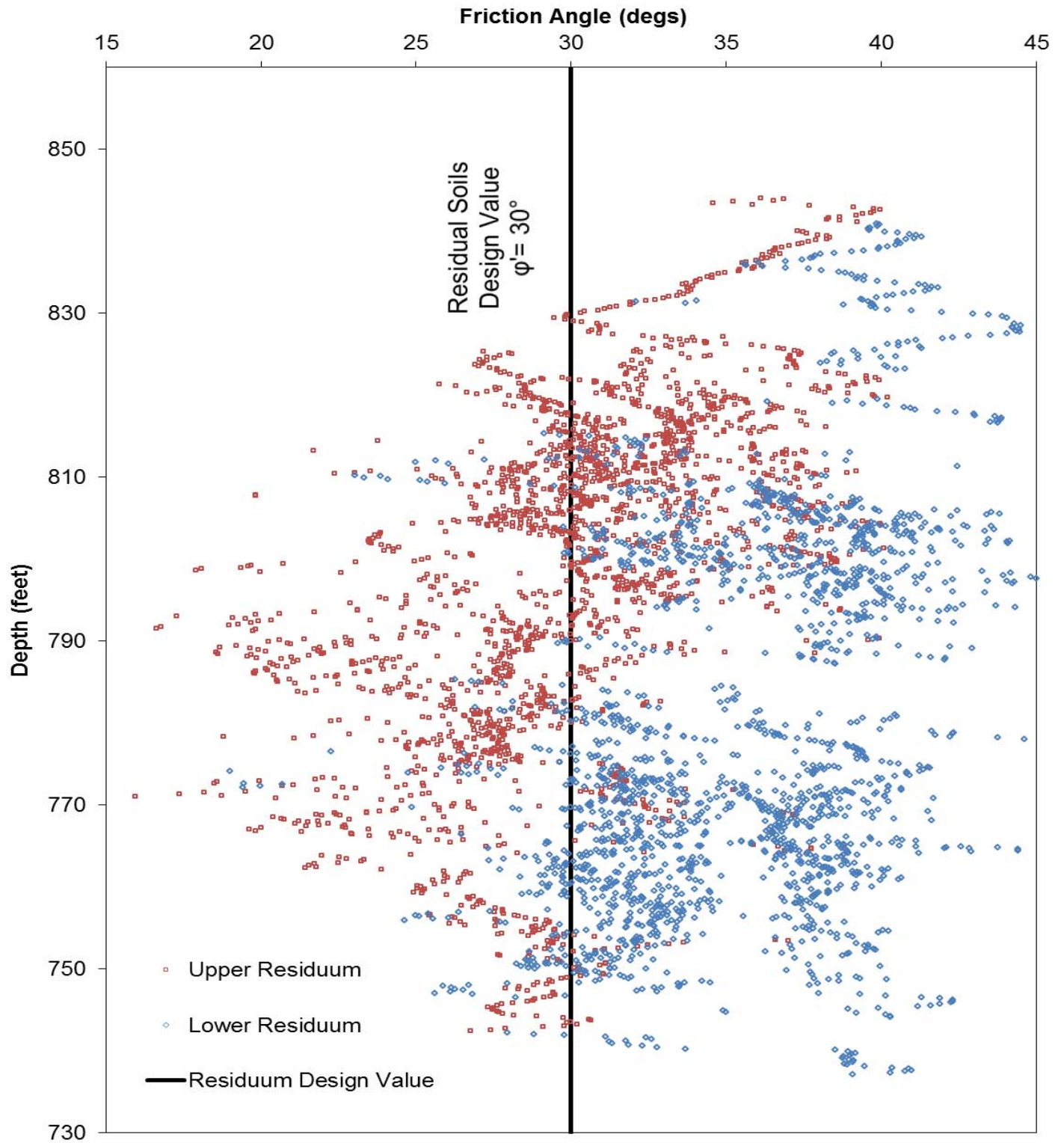
ENTER SECANT FRICTION ANGLES  
OBTAINED FROM MESRI & SHAHIEN 2003  
FIG. 2

OBTAIN RESULTS FOR M-C PARAMETERS

Effective Normal Stress (kPa)	Fully Softened Secant Friction Angle (°)	Calculated Shear Stress (kPa)
$\sigma'_n$	$(\phi'_{fs})_{sec}$	$\tau_{fs}$
50 kPa	33.0	32 kPa
100 kPa	32.0	62 kPa
400 kPa	30.0	231 kPa
Mohr-Coulomb Tangent $\phi'$ and $c'$ Data		
Fully Softened	$c'$	5.0 kPa
	$(\phi'_{fs})_{tan}$	29.5 °

 Golder Associates Inc.	SCALE	AS SHOWN	TITLE <b>Plant McDonough Material Property Analysis</b> <b>Correlation Between Fully-Softened Friction Angle and Plasticity Index by Mesri and Shahien (2003) (data from Stark and Eid 1994; Eid 1996; and Stark and Eid 1997)</b>
	DATE	Dec 2015	
	MADE BY	TPC	
	CAD	-	
FILE	CHECK	WRP	Southern Company Services
PROJECT No. 1539180	REVIEW	GLH	
REV. 0			

# CPT Based Residuum Effective Friction Angle




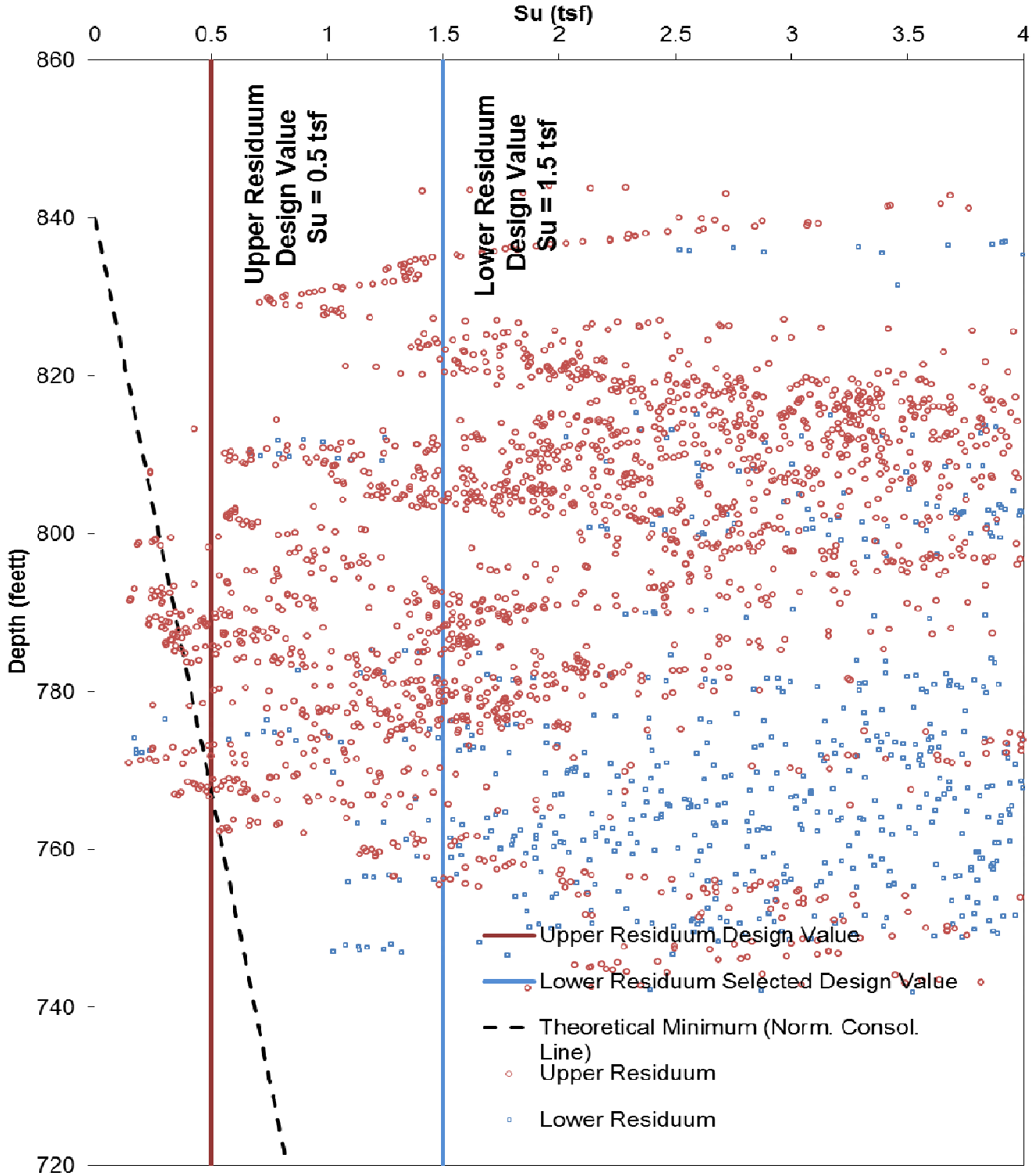
 <b>GOLDER</b> <small>Golder Associates Inc.</small>	SCALE	AS SHOWN	<b>Peak Friction Angle Based On CPT Correlation and Lab Results (Direct Shear)</b>  <b>Correlation Developed By Mayne And Kulhawy 1996</b>	
	DATE	Dec 2015		
DESIGN				
DRAWN	WRP			
CHECK				
PROJECT No.	1539180	REV.	0	REVIEW

Figure 10



# CPT Based Residuum Undrained Shear Strength



<p style="font-size: 24px; font-weight: bold; margin: 0;">GOLDER</p> <p style="font-size: 10px; margin: 0;">Golder Associates Inc.</p>	SCALE	AS SHOWN	<p style="font-weight: bold; margin: 0;">Undrained Shear Strength Based On CPT Correlation</p> <p style="font-weight: bold; margin: 0;">Correlation Based On Robertson et al. 1986 and Lunne et al. 1997</p>
	DATE	Dec 2015	
	DESIGN		
	DRAWN	WRP	
	CHECK	JGM	
REVIEW	GLH		
Figure 11	PROJECT No. 1539180	REV. 0	

### 1.0 Typical Values and Terminology

Undrained shear strength and effective friction angle correlations based on consistency and density from Peck, Hanson, and Thornburn (1974) are shown in Tables 1 and 2 below.

Table 1 - Fine Grained Soils			
Consistency	Field Identification	Undrained Shear Strength (kPa)	
Very Soft	Extrudes between fingers when squeezed	0	12
Soft	Molded by light finger pressure	12	25
Firm	Molded by strong finger pressure	25	50
Stiff	Indented by thumb	50	100
Very Stiff	Indented by thumbnail	100	200
Hard	Difficult to indent with thumbnail	> 200	

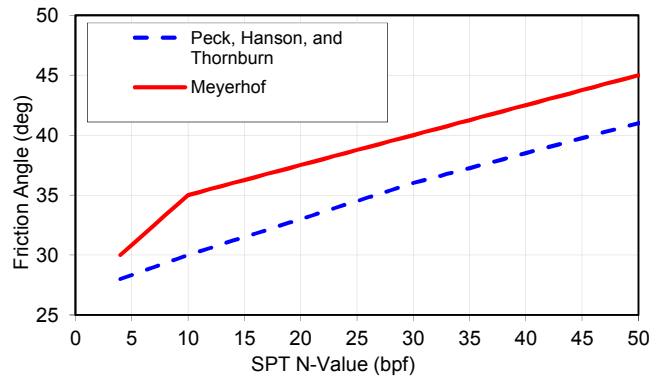
Table 2 - Coarse Grained Soils			
Density	Field Identification	Dr (%)	$\phi'$ (Deg)
Very Loose	Easily penetrated with shovel handle	<20	< 29
Loose	Easily penetrated with 1/2 inch rebar pushed by hand. Easily excavated with hand shovel.	20 - 40	29 - 30
Compact	Easily penetrated with 1/2 inch rebar driven by 5 lb. hammer. Difficult to excavate with hand shovel.	40 - 60	30 - 36
Dense	Penetrated 1 foot with driven rebar. Must be loosened with pick to hand excavate.	60 - 80	36 - 41
Very Dense	Penetrated only a few inches with driven rebar. Very difficult to excavate even with pick.	> 80	> 41

$D_r$  (%) = Relative Density =  $(e_{max} - e) / (e_{max} - e_{min}) * 100\%$ .

$\phi'$  (Deg) = Effective Friction Angle

Effective friction angle correlations based on SPT N-values from Peck et al. and Meyerhof are shown in Table 3 and Figure 1 below.

Table 3: Estimation of Granular Material Effective Friction Angle Based on SPT N-Value (EPRI, 1990)		
N-Value(blow/ft)	Approximate $\phi'$ (deg)	
	Peck et al.	Meyerhof
0 to 4	< 28	< 30
4 to 10	28 to 30	30 to 35
10 to 30	30 to 36	35 to 40
30 to 50	36 to 41	40 to 45
> 50	> 41	> 45



**Figure 1:** Graphical Representation of Table 1

Correlations from Terzaghi et al. (1996) can be used to estimate friction angles of cohesive soils using laboratory data of plasticity index (PI). NAVFAC Design Manual 7.02 also gives estimated correlations for effective friction angle for various fine-grained material, as referenced in the table below.

For PI < 100:  $\phi' = 0.0013(PI)^2 - 0.2717(PI) + 35.876$   $R^2 = 0.9972$  (Terzaghi et al., 1996)

Table 4: Estimation of effective friction angle based on USCS (for Compacted Fine-Grained Material) (NAVFAC, 1986)		
USCS	Soil Type	Effective Friction Angle (deg)
ML	Inorganic silts and clayey silts	32
ML-CL	Mixture of inorganic silt and clay	32
CL	Inorganic clays of low to medium plasticity	28
MH	Inorganic clayey silts, elastic silts	25
CH	Inorganic clays of high plasticity	19

## 2.0 Cone Penetration Testing

The CPT soundings in this study were completed with a 10 cm<sup>2</sup> area (3.57 cm diameter) piezocone using operating procedures in accordance with ASTM Standard D-5778. Pore pressure filter elements, made of porous plastic, were saturated under a vacuum using silicone oil as the saturating fluid. The pore pressure element was six millimeters (mm) thick and was located immediately behind the tip (the u<sub>2</sub> location) for all soundings. The cone was advanced using a WWC-707 drill rig mounted on tracks owned and operated by CONETEC.

Raw CPT data measurements of the following parameters were recorded at a rate of 1 measurement every 1 mm of penetration:

- tip stress (qc)
- sleeve friction (fs)
- pore pressure (u<sub>2</sub>)
- Dual Axis Inclination (Ix & Iy)
- Temperature (T)
- rate of penetration (v).

Golder used the CPT data processing software CPT-It by Geologismiki to provide initial processing of the raw data into engineering units of the standard CPT presentation parameters:

- corrected cone resistance (qt)
- friction ratio (Rf)
- pore pressure (u<sub>2</sub>)
- soil behavior type index (Ic SBT)
- soil behavior type (SBT) based on the Robertson (2010) soil classification scheme
- normalized cone tip resistance (Qtn)
- normalized friction ratio (Fr)
- normalized pore pressure ratio (Bq)
- normalized soil behavior type index (Ic)
- normalized soil behavior type (SBTn) based on the Robertson (1990) soil classification scheme

**SUBJECT: Estimation of Ash Pond Materials Properties**

Project Number: 1539180

Project Name: Plant McDonough AP-3 and AP-4 Closure

Prepared by: WRP

Checked by: TPC

Date: Dec 2015

Reviewed by: GLH

Equations (1) and (2) present the relationships for  $q_t$  and  $R_f$ :

$$q_t = q_c + u_2 (1-a) \quad (1)$$

$$R_f = f_s / q_t \times 100\% \quad (2)$$

The parameter 'a' in equation (1) is known as the end area ratio of the cone penetrometer device. This parameter represents the ratio of the cross-sectional area of the tip load cell element along the shaft to that of the projected cone area. It corrects the measured cone tip stress ( $q_c$ ) to account for the effects of water pressure acting unequally on the geometry of the cone tip. For the 10 cm<sup>2</sup> cone, the value of 'a' is 0.8, as provided by the manufacturer's calibration.

Equation (3) presents the un-normalized relationship used to determine  $I_c$  SBT presented in Attachment 2,

$$I_c \text{ SBT} = [(3.47 - \log(q_t / p_a))^2 + (\log R_f + 1.22)^2]^{0.5} \quad (3)$$

Equations (4) to (6) present the normalized relationships used to generate the SBT<sub>n</sub> and  $I_c$  values presented in Attachment 2,

$$Q_{tn} = ((q_t - \sigma_v0) / p_a) \times (p_a / \sigma_v0)^n \quad (4)$$

$$F_r = f_s / (q_t - \sigma_v0) \times 100\% \quad (5)$$

$$B_q = (u_2 - u_0) / (q_t - \sigma_v0) \quad (6)$$

where:

$$n = 0.381 \times I_c + 0.05 \times ((\sigma_v0') / p_a) - 0.15$$

$$I_c = [(3.47 - \log(Q_{tn}))^2 + (\log F_r + 1.22)^2]^{0.5}$$

The parameters [ $\sigma_v0$  and  $\sigma_v0'$ ] in the above equations represent the total and effective vertical stress at a given measurement location, respectively. The parameters [ $u_2$  and  $u_0$ ] in the above equations are the dynamic pore pressure measured during CPT penetration and the static equilibrium pore pressure at a given measurement location, respectively. The parameter  $p_a$  in the above equations is the atmospheric pressure, i.e. ~101 kPa = 1.06 tsf.

Attachment 2 to this report provides plots of the above-described standard and normalized parameters for each of the completed CPT soundings providing a near continuous profile of the encountered ground conditions.

Prior to performing each CPT, the piezocone tip and sleeve were removed from the piezocone housing, cleaned, lubricated and reassembled with a new pore pressure filter element. Each pore pressure filter element was pre-saturated (free of air). A latex membrane was placed on the piezocone tip after piezocone cleaning and lubrication to avoid de-saturation of the pore pressure element while waiting for the start of each test and was removed prior to performing the test. The potentiometer and piezocone instruments were connected to a data control box where the measurements were saved for post-processing and also viewed real-time on a ruggedized field computer

## References

FHWA (1998), Training Course in Geotechnical and Foundation Engineering - Rock Slopes, Publication No. FHWA HI-99-007

Mesri, G. and Shahien, M. (2003) "Residual Shear Strength Mobilized in First-Time Slope Failures," JGGE, 129, 1, 12-31.

Gregg Drilling, "Guide to Cone Penetration Testing", 6th Edition 2015.

Kulhawy, F. H. and Mayne, P.W. (1990). Manual on Estimating Soil Properties for Foundation Design, EL-6800, Electric Power Research Institute (EPRI).

Terzaghi, K., Peck, R.B., Mesri, G. (1996). Soil Mechanics in Engineering Practice, 3rd Edition, John Wiley & Sons, New York. Figure 19.7

Naval Facilities Engineering Command (NAVFAC) (1986). Design Manual 7.02 Foundations and Earth Structures.

**APPENDIX B**

**Stability Analysis Figures for  
AP-2 and AP-3/4**

Path: \\atlanta\cadd\southern\company\1777449\Plant\_McDonough\_State\_Permitting\PRODUCTION\CLOSURE PERMIT\1 File Name: 1777449\_ASP-DI-02\_CLOSURE PERMIT.dwg

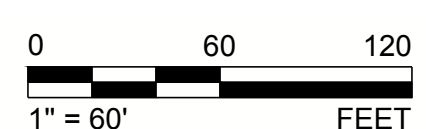


**LEGEND**

EXISTING CONTOURS

**REFERENCES**

1. THE EXISTING TOPOGRAPHY SHOWN EVERYWHERE ELSE WAS PROVIDED BY SOUTHERN COMPANY SERVICES AS AN INTERIM CONSTRUCTION PROGRESS SURVEY. FLOWN ON 04-15-17 USING LIDAR.



CLIENT  
GEORGIA POWER COMPANY /  
SOUTHERN COMPANY SERVICES



PROJECT  
PLANT MCDONOUGH  
CLOSURE PERMIT PLANS

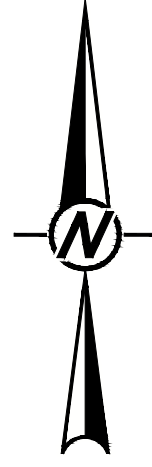
TITLE  
**ASH POND 2 - STABILITY SECTIONS PLAN**

CONSULTANT	YYYY-MM-DD	2018/02/15
	DESIGNED	LJ
	PREPARED	RMS
	REVIEWED	JGM
	APPROVED	GLH

PROJECT NO.  
1777449

SHEET  
**1**

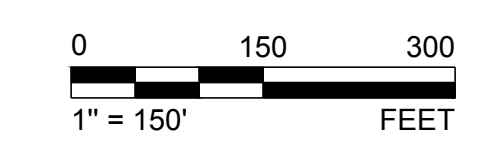
IF THIS MEASUREMENT DOES NOT MATCH WHAT IS SHOWN, THE SHEET SIZE HAS BEEN MODIFIED FROM ANS/D



**LEGEND**

	EXISTING CONTOURS
	PROPERTY BOUNDARY MARKERS/LIMITS
	FINAL CLOSURE CONTOURS & FINAL LIMITS OF ASH
	CLEAN CLOSURE CONTOURS
	EXISTING OVERHEAD ELECTRIC LINES IN ASH POND 3 & 4

- REFERENCES**
1. THE EXISTING TOPOGRAPHY AND CONTOUR ELEVATIONS WERE PROVIDED BY GEORGIA LAND DEPARTMENT AND METRO ENGINEERING AND SURVEYING CO., INC. THE DATE OF THE SURVEY PROVIDED AND SHOWN ON THIS SET OF PLANS IS 10-16-2012. REFER TO THE SURVEY DRAWING TITLED "TOPOGRAPHIC MAP PREPARED FOR GEORGIA POWER COMPANY PLANT MCDONOUGH - GEORGIA STATE PLANE WEST SURVEY FEET - DATE OF PHOTOGRAPHY 10-26-12. PROJECT NO. 13225 - 01-13-2013."
  2. THE REVISED TOPOGRAPHY & CONTOUR ELEVATIONS WERE PROVIDED BY GEORGIA POWER LAND DEPARTMENT. THE DATA SHOWN IS AN UPDATE TO THE PLANS DONE ON 10-16-2012 & THE ONSITE CHANGES SINCE THAT 2012 SURVEY. THE REVISED SURVEY WAS DONE ON 1-12-2016 & MERGED WITH THE DATA ON 10-16-2012.
  3. GEORGIA POWER COMPANY PLANT MCDONOUGH ASH PONDS - GEORGIA STATE PLANE WEST SURVEY FEET - DATE OF SURVEY 1-12-2016 - LAND ENG. PROJECT # 20160020.



CLIENT  
 GEORGIA POWER COMPANY /  
 SOUTHERN COMPANY SERVICES



PROJECT  
 PLANT MCDONOUGH  
 CLOSURE PERMIT PLANS

TITLE  
**ASH POND 3 & 4 - STABILITY SECTIONS PLAN**

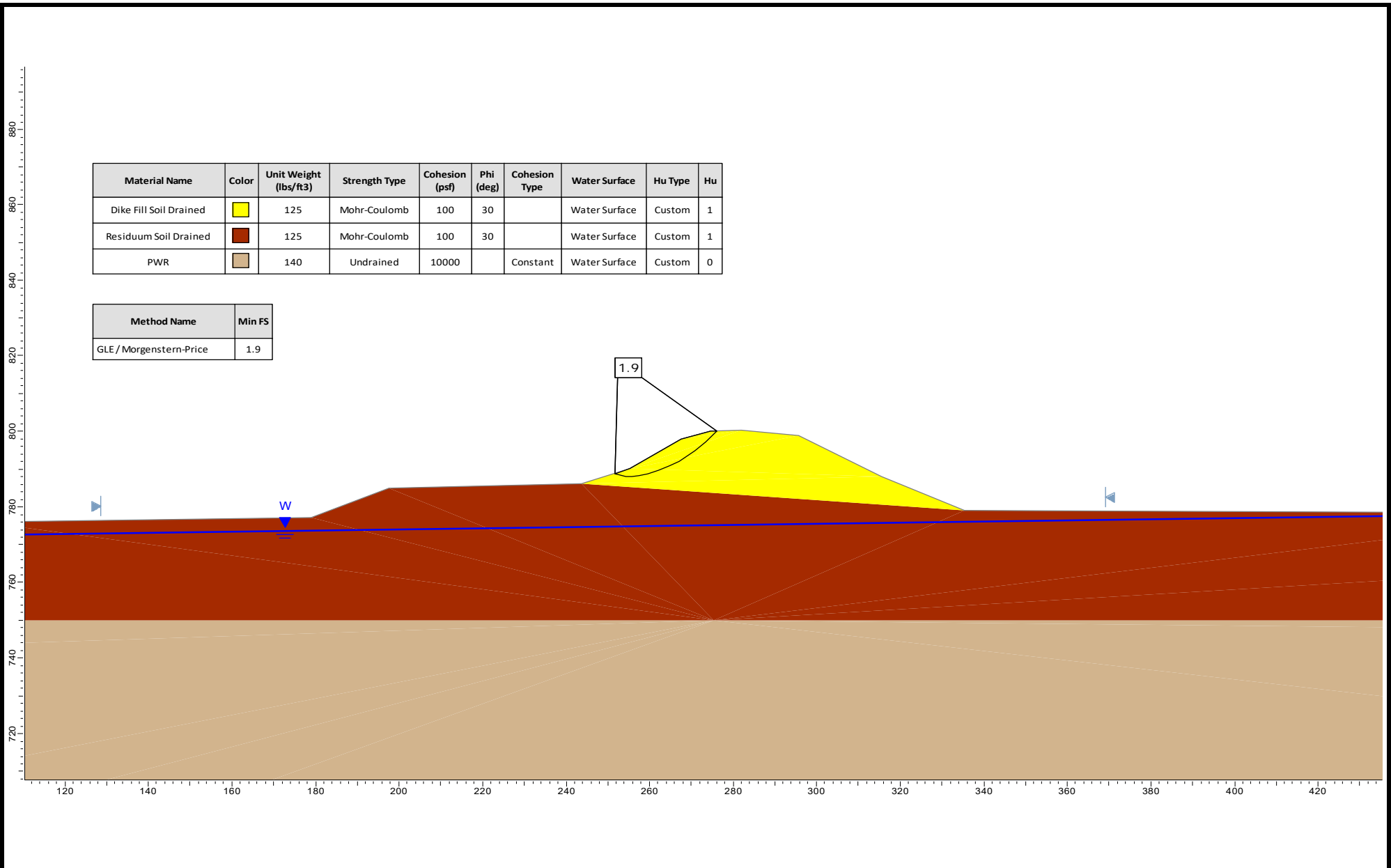
CONSULTANT	YYYY-MM-DD	2018/02/15
	DESIGNED	LJ
	PREPARED	RMS
	REVIEWED	JGM
	APPROVED	GLH


PROJECT NO.  
 177749

SHEET  
 2

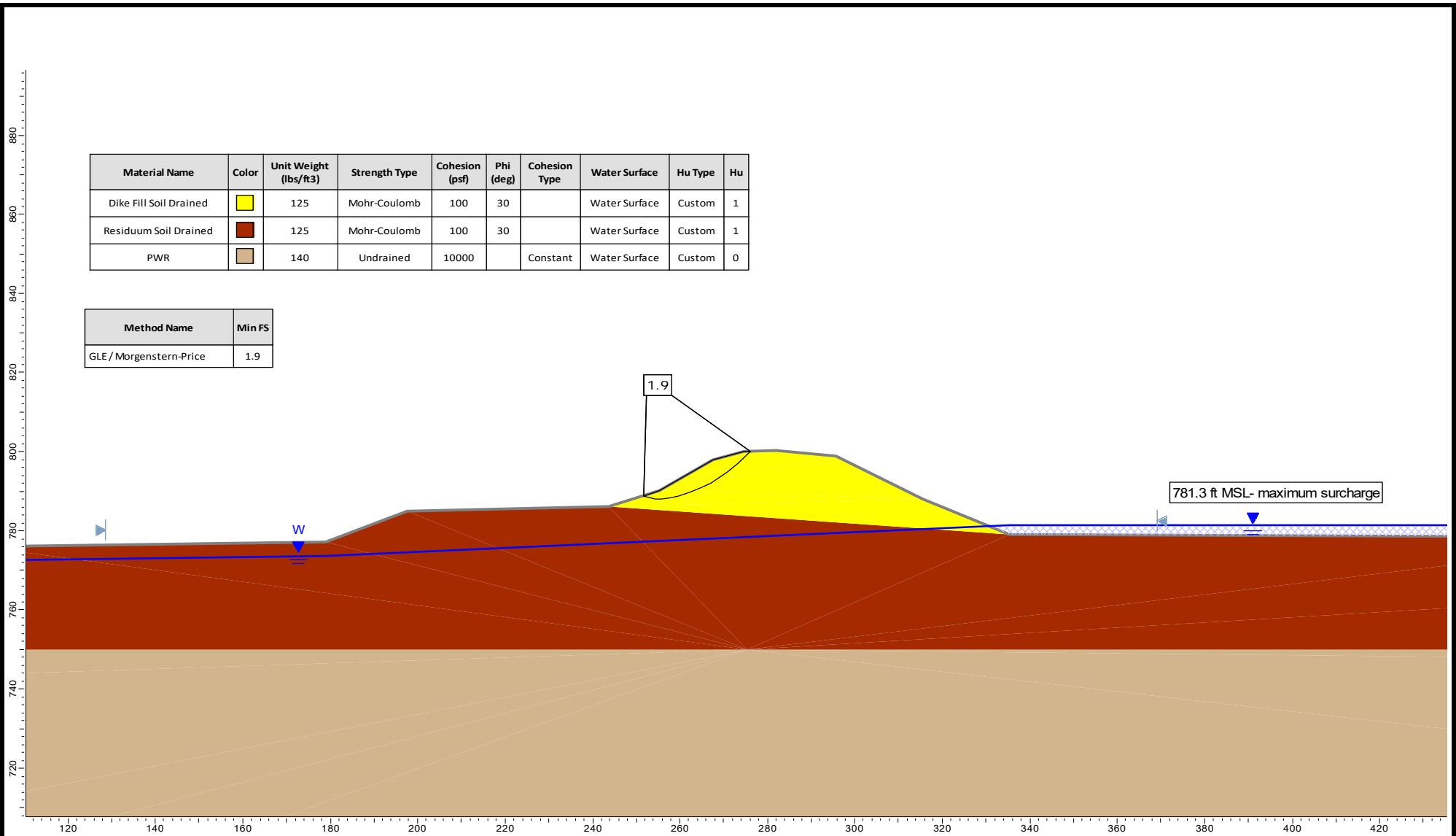
Path: \\atlanta\cadd\Southern Company\177749 Plant McDonough State Permitting\PRODUCTION\CLOSURE PERMIT\_1 File Name: 177749-SP-03-01\_CLOSURE PERMIT.dwg

1 in IF THIS MEASUREMENT DOES NOT MATCH WHAT IS SHOWN, THE SHEET SIZE HAS BEEN MODIFIED FROM ANSI D




	SCALE	AS SHOWN	PROJECT	Closure Design - Plant McDonough AP-2	
	DATE	Jan 2018	TITLE	Section 2A-2A Storage Pool	
	MADE BY	LJ			
	CAD	-			
FILE	STABILITY	CHECK	JGM	CLIENT	Georgia Power Company
PROJECT No.	1777449	REV.	0	REVIEW	GLH
				FIGURE	3(a)

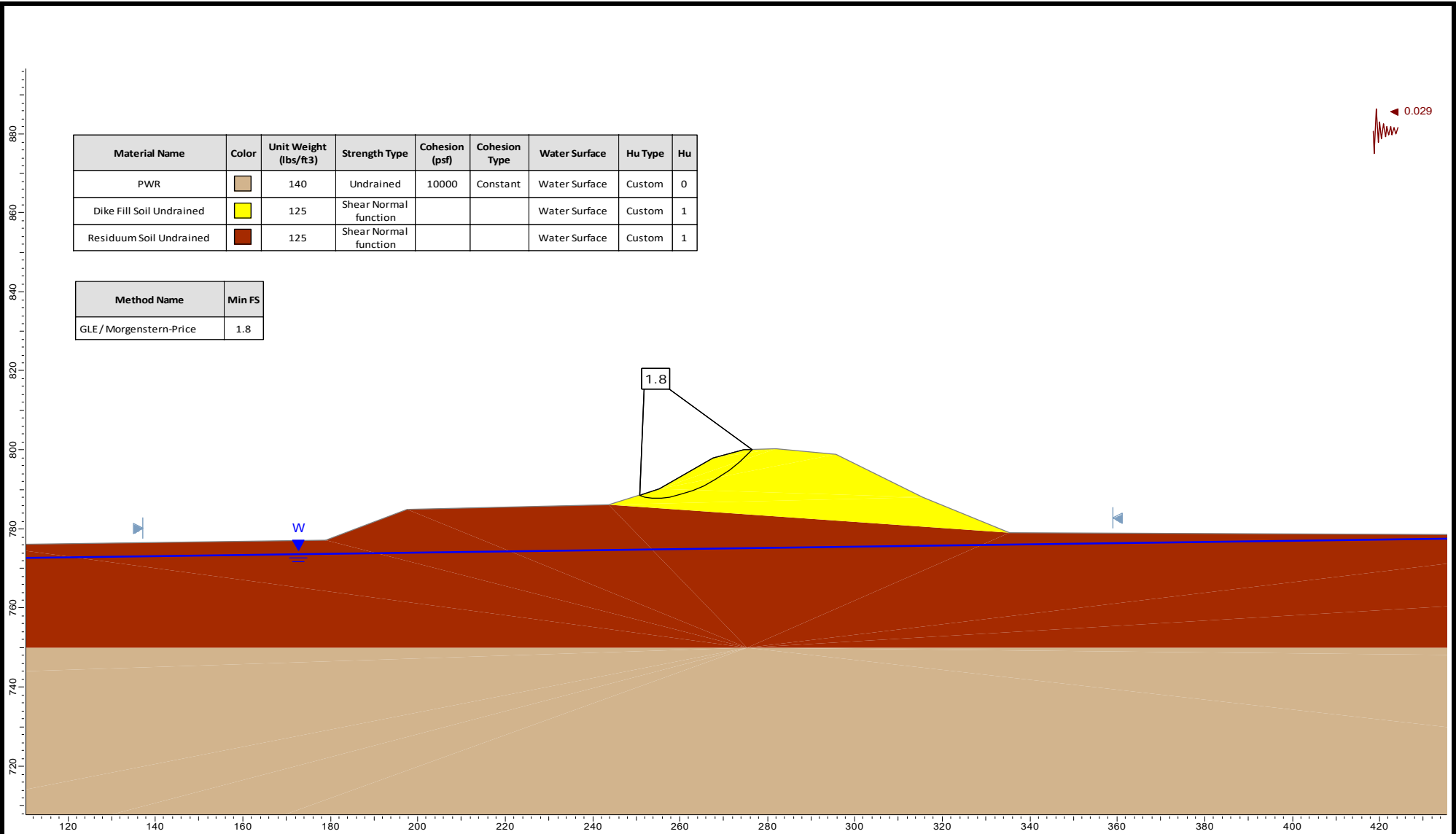




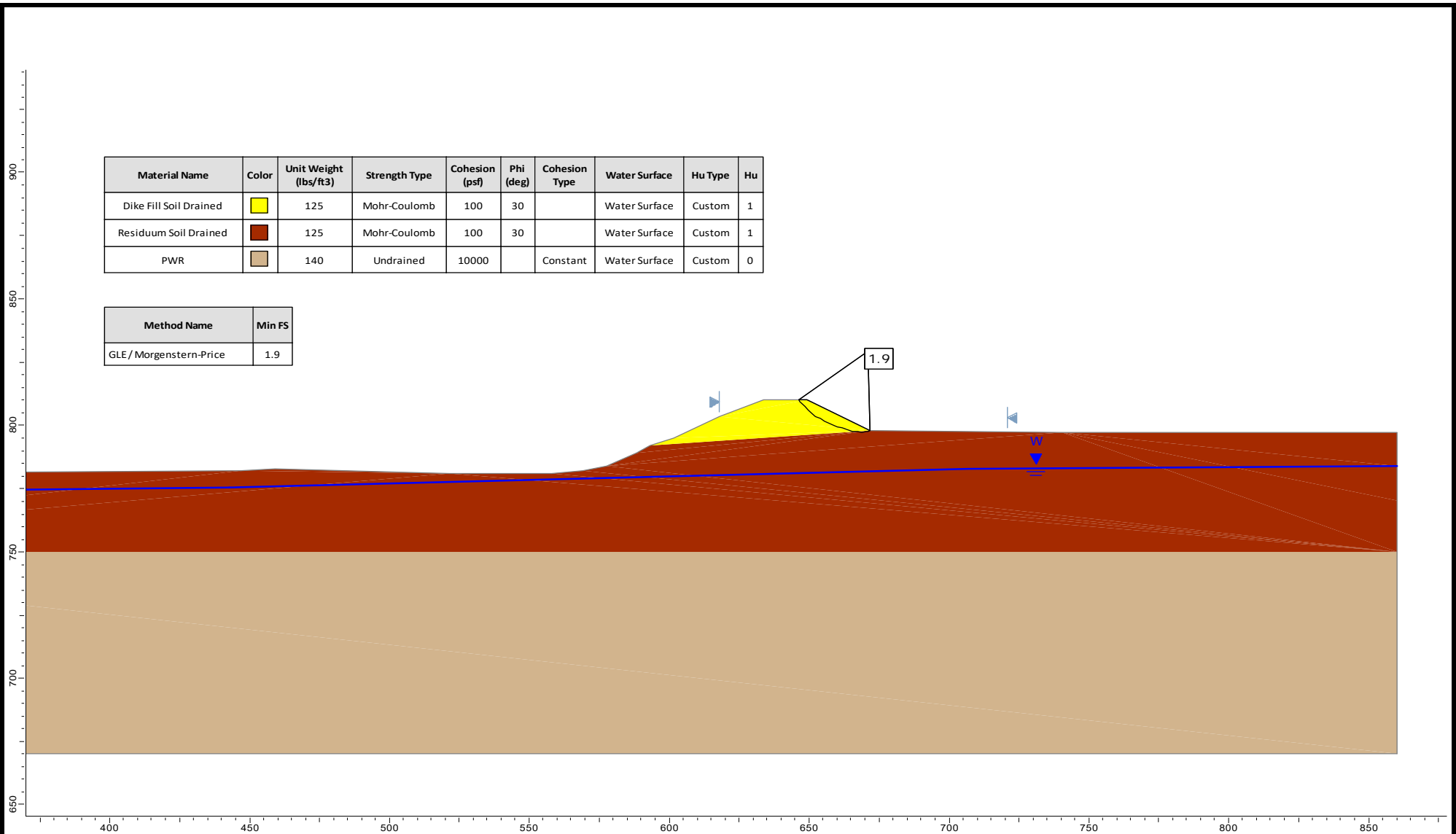
Material Name	Color	Unit Weight (lbs/ft3)	Strength Type	Cohesion (psf)	Phi (deg)	Cohesion Type	Water Surface	Hu Type	Hu
Dike Fill Soil Drained	Yellow	125	Mohr-Coulomb	100	30		Water Surface	Custom	1
Residuum Soil Drained	Brown	125	Mohr-Coulomb	100	30		Water Surface	Custom	1
PWR	Tan	140	Undrained	10000		Constant	Water Surface	Custom	0


Method Name	Min FS
GLE / Morgenstern-Price	1.9

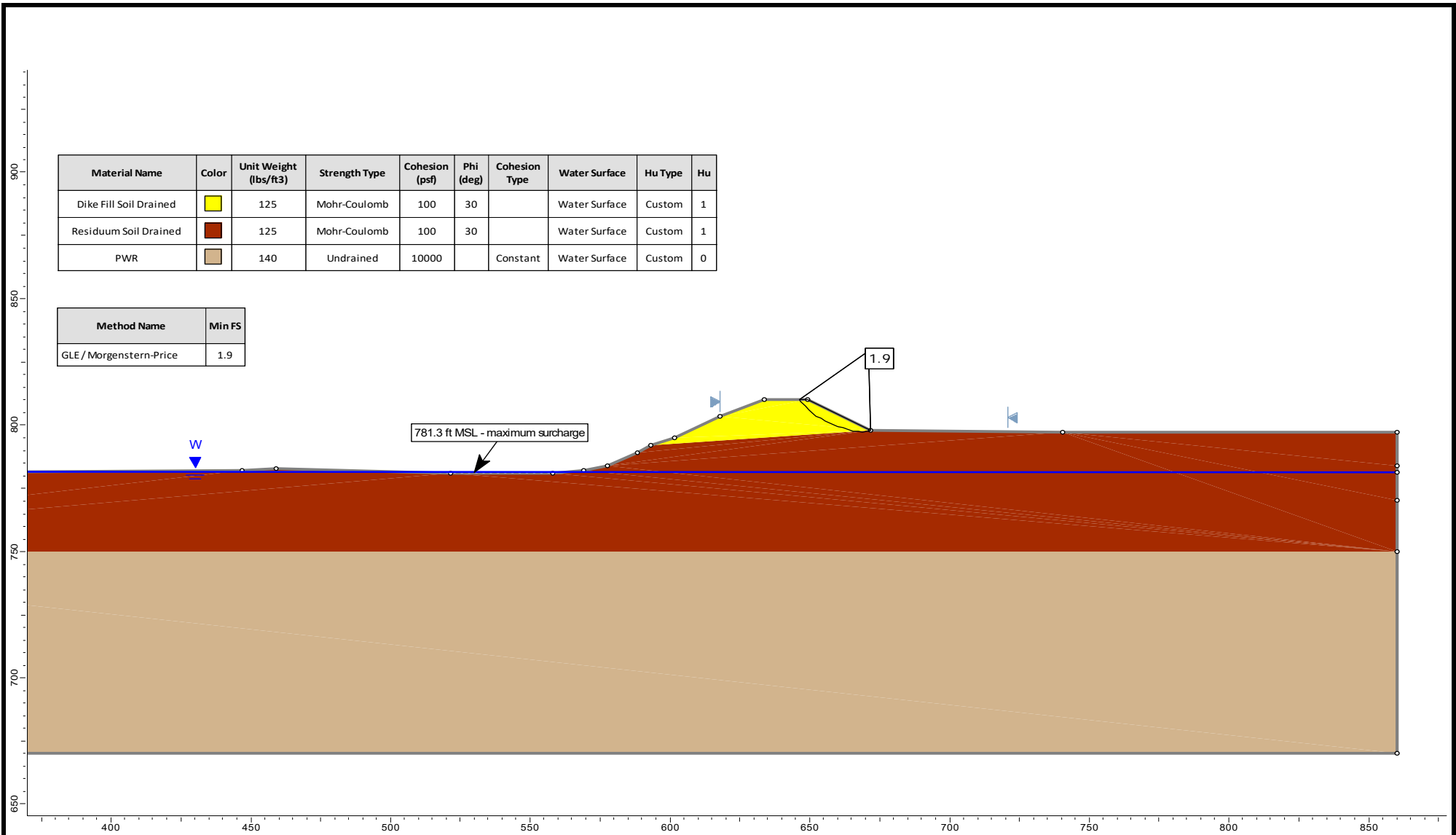
	SCALE	AS SHOWN	PROJECT	Closure Design - Plant McDonough AP-2	
	DATE	Jan 2018	TITLE	Section 2A-2A Surcharge Pool	
	MADE BY	LJ	CLIENT	Georgia Power Company	
	CAD	-	FIGURE	3(b)	
FILE	STABILITY	CHECK	JGM		
PROJECT No.	1777449	REV.	0	REVIEW	GLH




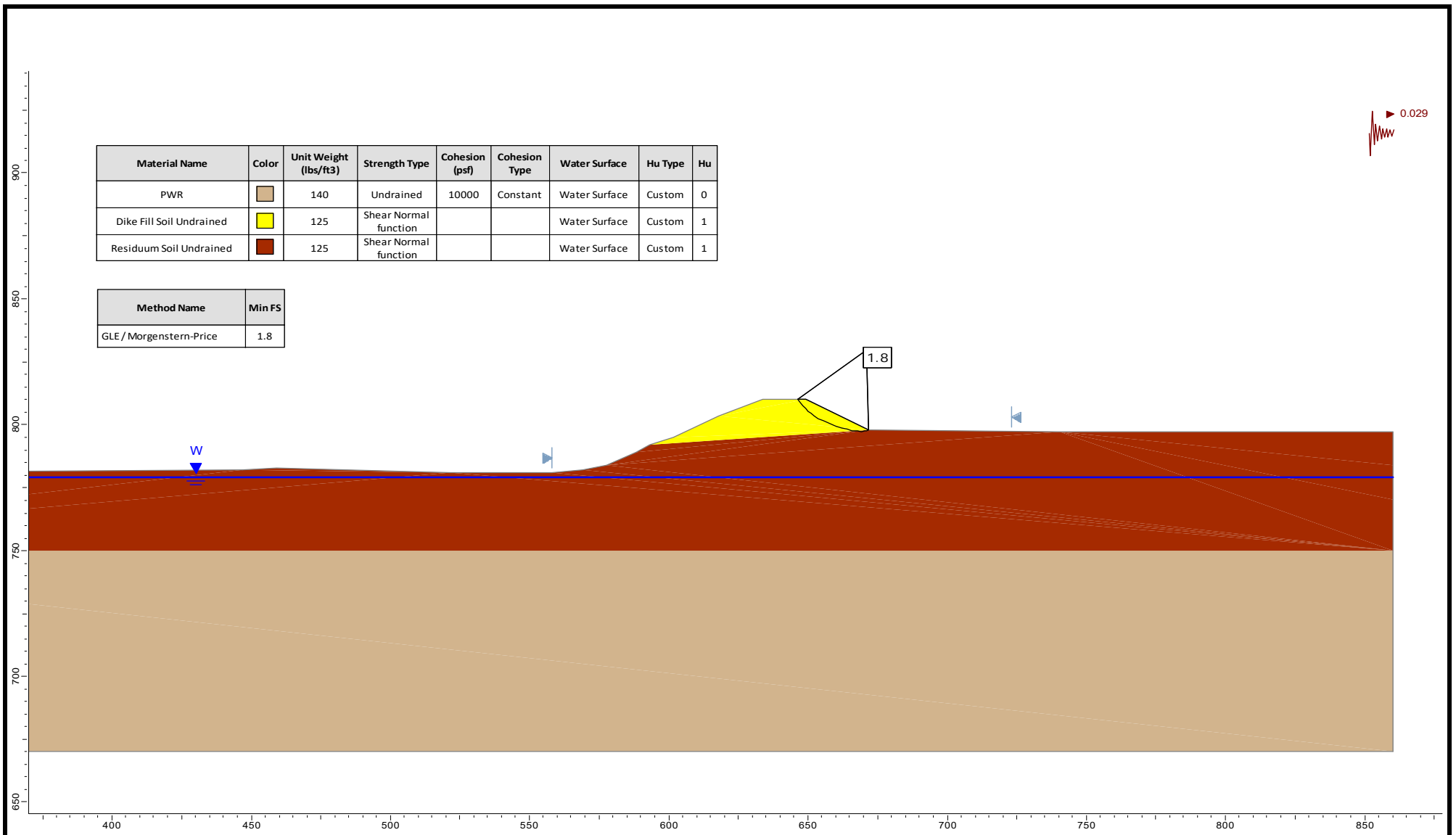
	SCALE	AS SHOWN	PROJECT	Closure Design - Plant McDonough AP-2	
	DATE	Jan 2018	TITLE	Section 2A-2A Seismic Screening	
	MADE BY	LJ			
	CAD	-			
FILE	STABILITY	CHECK	JGM	CLIENT	Georgia Power Company
PROJECT No.	1777449	REV.	0	REVIEW	GLH
				FIGURE	3(c)



 <b>GOLDER</b>	SCALE	AS SHOWN	PROJECT	<b>Closure Design - Plant McDonough AP-2</b>	
	DATE	Jan 2018	TITLE	<b>Section 2B-2B Storage Pool</b>	
	MADE BY	LJ	CLIENT	<b>Georgia Power Company</b>	
	CAD	-	FIGURE	<b>4(a)</b>	
FILE	STABILITY	CHECK	JGM		
PROJECT No.	1777449	REV.	0		
		REVIEW	GLH		



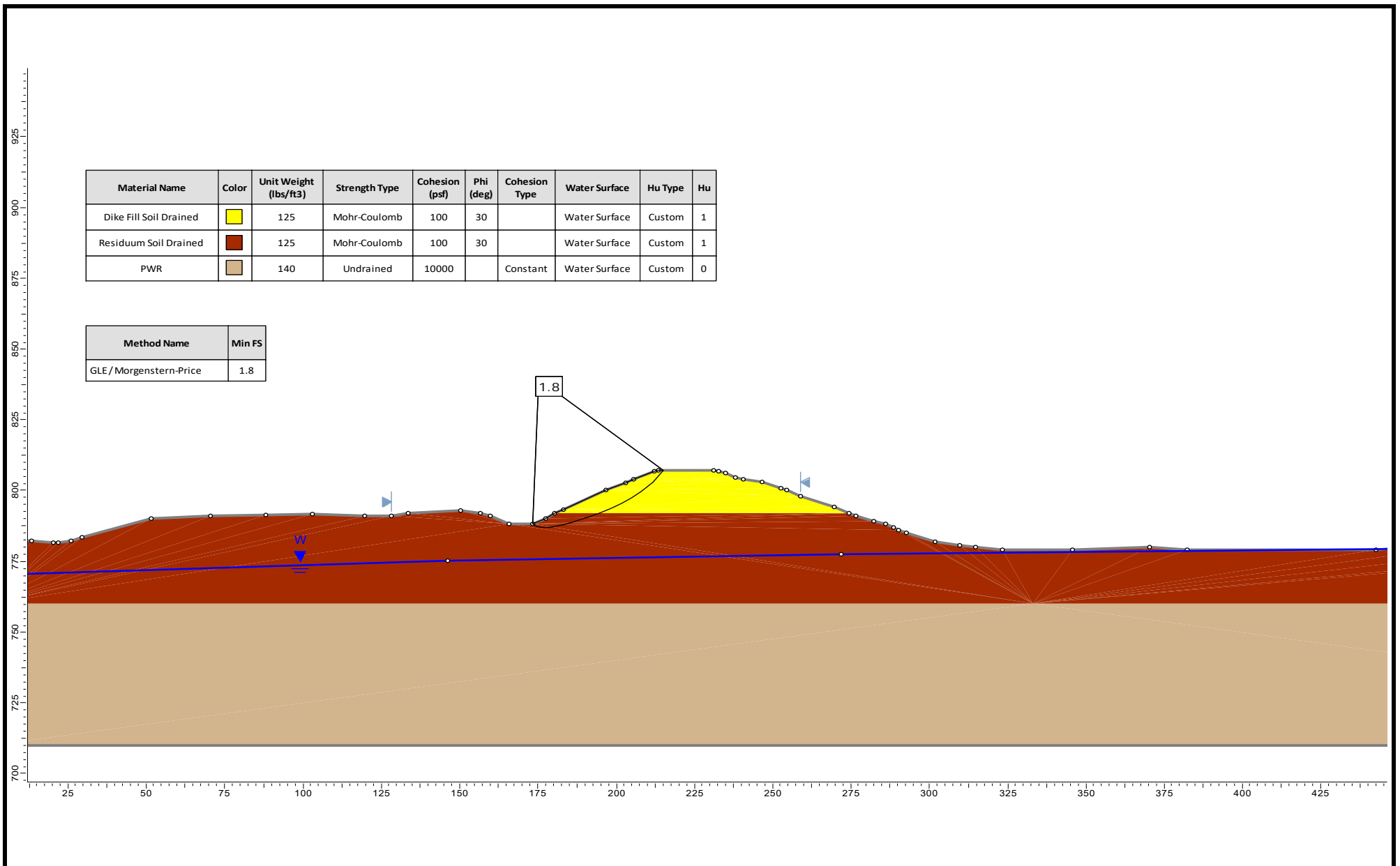
	SCALE	AS SHOWN	PROJECT	<b>Closure Design - Plant McDonough AP-2</b>	
	DATE	Jan 2018	TITLE	<b>Section 2B-2B Surcharge Pool</b>	
	MADE BY	LJ			
	CAD	-			
FILE	STABILITY	CHECK	JGM	CLIENT	<b>Georgia Power Company</b>
PROJECT No.	1777449	REVIEW	GLH	FIGURE	



Material Name	Color	Unit Weight (lbs/ft3)	Strength Type	Cohesion (psf)	Cohesion Type	Water Surface	Hu Type	Hu
PWR		140	Undrained	10000	Constant	Water Surface	Custom	0
Dike Fill Soil Undrained		125	Shear Normal function			Water Surface	Custom	1
Residuum Soil Undrained		125	Shear Normal function			Water Surface	Custom	1


Method Name	Min FS
GLE / Morgenstern-Price	1.8

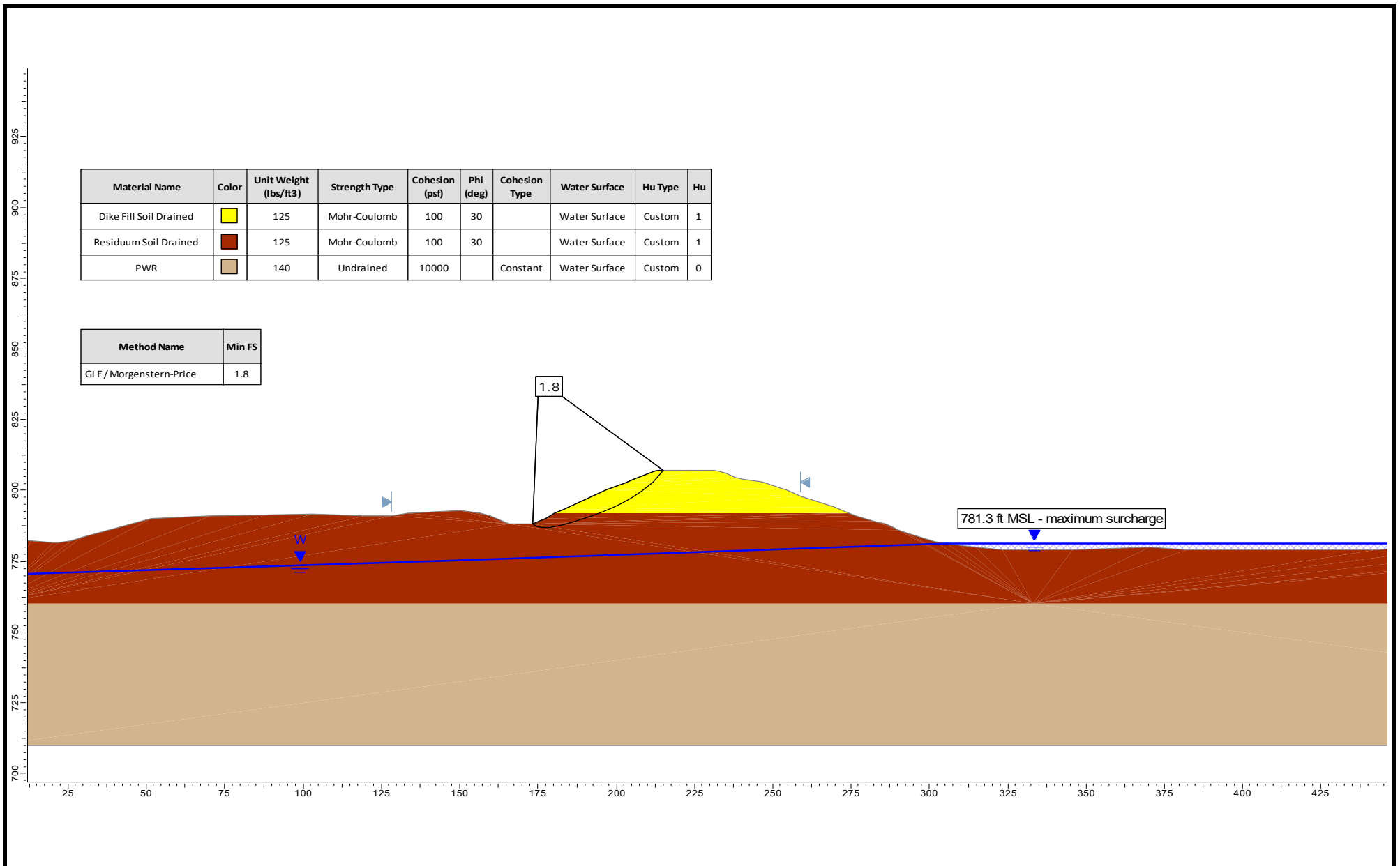
	SCALE	AS SHOWN	PROJECT	Closure Design - Plant McDonough AP-2	
	DATE	Jan 2018	TITLE	Section 2B-2B Seismic Screening	
	MADE BY	LJ			
	CAD	-			
FILE	STABILITY	CHECK	JGM	CLIENT	Georgia Power Company
PROJECT No.	1777449	REV.	0	REVIEW	GLH
				FIGURE	4(c)



Material Name	Color	Unit Weight (lbs/ft3)	Strength Type	Cohesion (psf)	Phi (deg)	Cohesion Type	Water Surface	Hu Type	Hu
Dike Fill Soil Drained	Yellow	125	Mohr-Coulomb	100	30		Water Surface	Custom	1
Residuum Soil Drained	Brown	125	Mohr-Coulomb	100	30		Water Surface	Custom	1
PWR	Tan	140	Undrained	10000		Constant	Water Surface	Custom	0


Method Name	Min FS
GLE/Morgenstern-Price	1.8

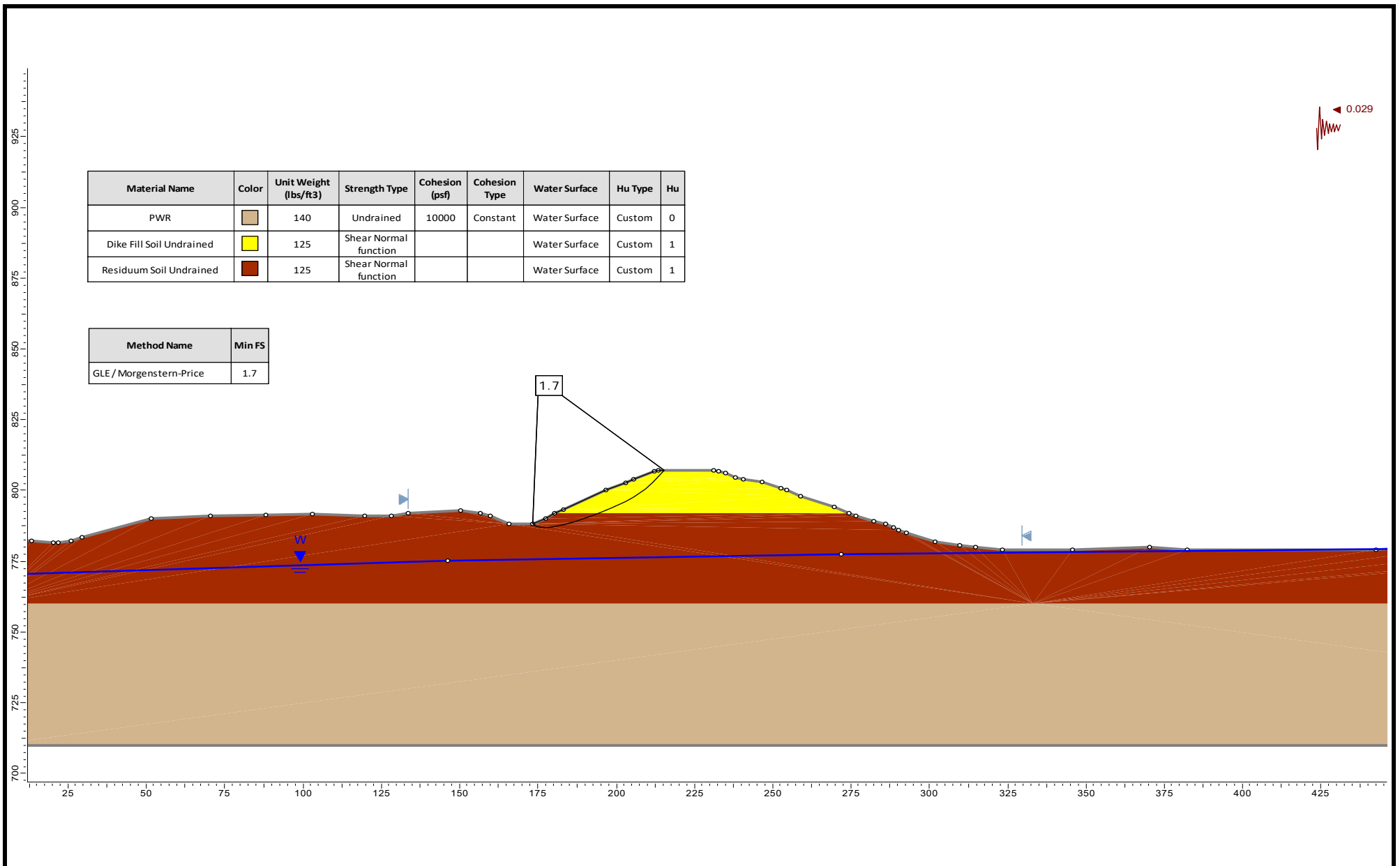
	SCALE	AS SHOWN	PROJECT	Closure Design - Plant McDonough AP-2	
	DATE	Jan 2018	TITLE	Section 2C-2C Storage Pool	
	MADE BY	LJ			
	CAD	-			
FILE	STABILITY	CHECK	JGM	CLIENT	Georgia Power Company
PROJECT No.	1777449	REV.	0	REVIEW	GLH
				FIGURE	5(a)



Material Name	Color	Unit Weight (lbs/ft3)	Strength Type	Cohesion (psf)	Phi (deg)	Cohesion Type	Water Surface	Hu Type	Hu
Dike Fill Soil Drained	Yellow	125	Mohr-Coulomb	100	30		Water Surface	Custom	1
Residuum Soil Drained	Brown	125	Mohr-Coulomb	100	30		Water Surface	Custom	1
PWR	Tan	140	Undrained	10000		Constant	Water Surface	Custom	0

Method Name	Min FS
GLE / Morgenstern-Price	1.8

	SCALE	AS SHOWN	PROJECT	Closure Design - Plant McDonough AP-2	
	DATE	Jan 2018	TITLE	Section 2C-2C Surcharge Pool	
	MADE BY	LJ	CLIENT	Georgia Power Company	
	CAD	-	FIGURE	5(b)	
FILE	STABILITY	CHECK	JGM		
PROJECT No.	1777449	REV.	0	REVIEW	GLH

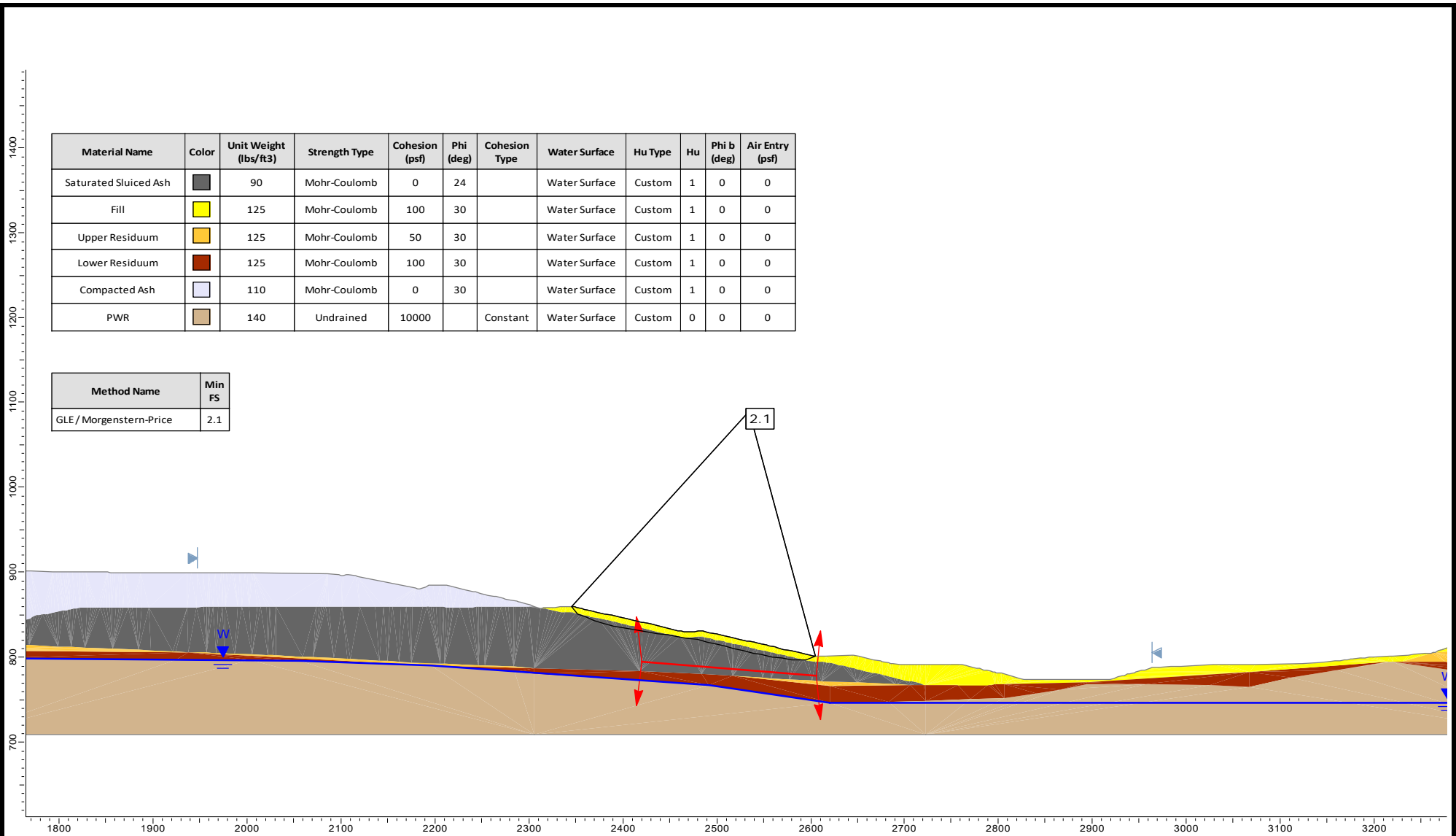


Material Name	Color	Unit Weight (lbs/R3)	Strength Type	Cohesion (psf)	Cohesion Type	Water Surface	Hu Type	Hu
PWR		140	Undrained	10000	Constant	Water Surface	Custom	0
Dike Fill Soil Undrained		125	Shear Normal function			Water Surface	Custom	1
Residuuum Soil Undrained		125	Shear Normal function			Water Surface	Custom	1

Method Name	Min FS
GLE / Morgenstern-Price	1.7

	SCALE	AS SHOWN	PROJECT	Closure Design - Plant McDonough AP-2	
	DATE	Jan 2018	TITLE	Section 2C-2C Seismic Screening	
	MADE BY	LJ			
	CAD	-			
FILE	STABILITY	CHECK	JGM	CLIENT	Georgia Power Company
PROJECT No.	1777449	REV.	0	REVIEW	GLH
				FIGURE	5(c)

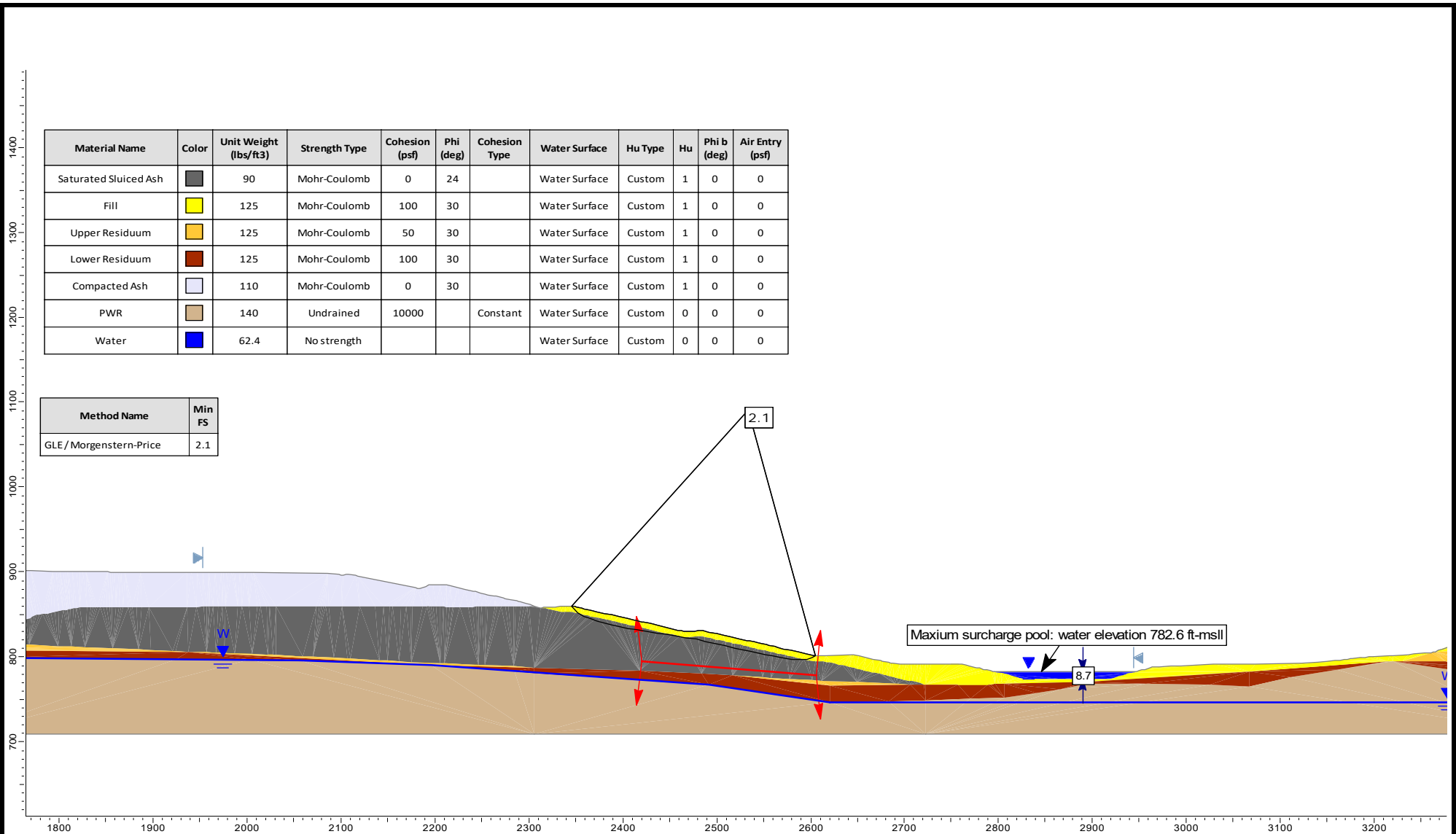





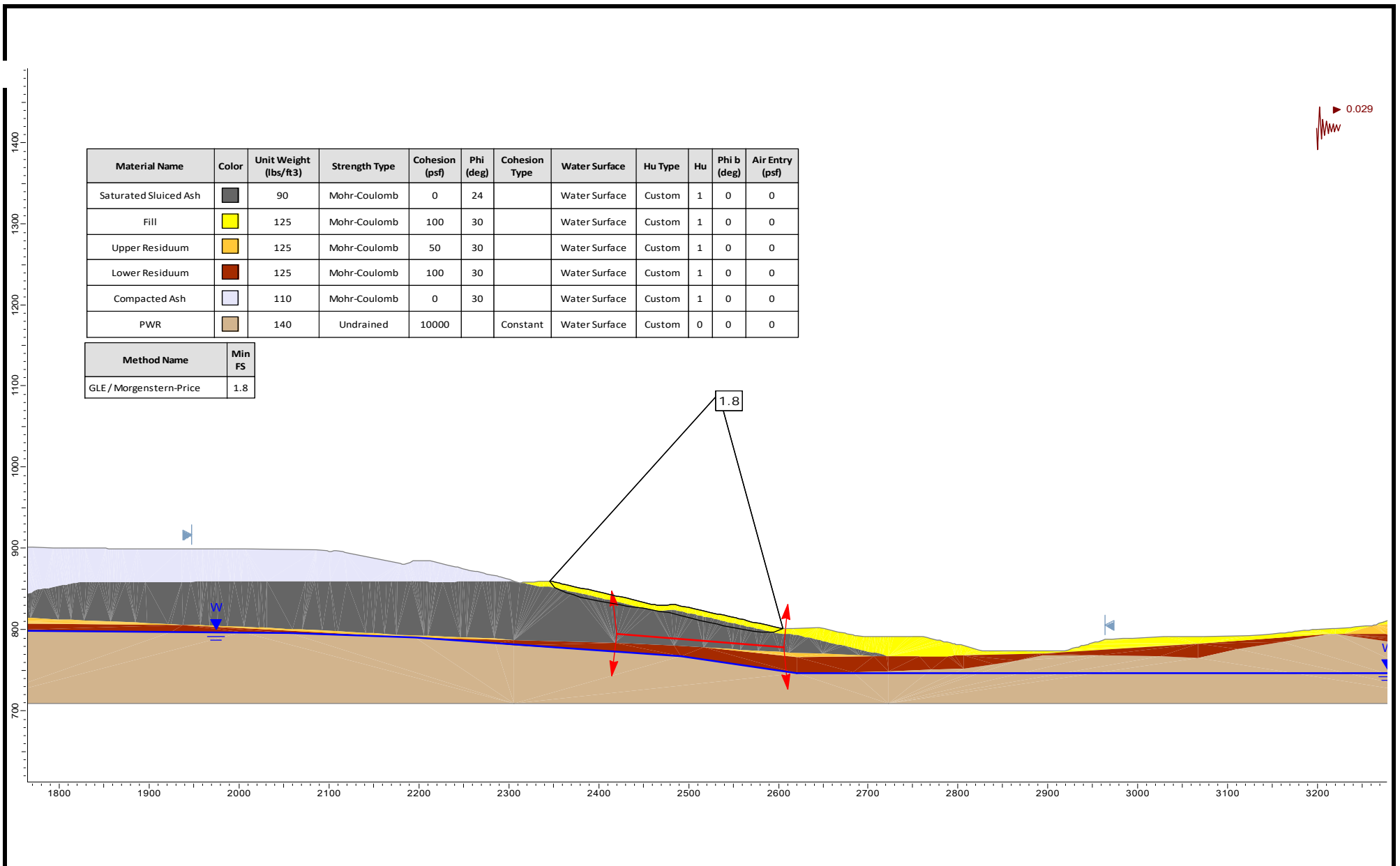
Material Name	Color	Unit Weight (lbs/ft <sup>3</sup> )	Strength Type	Cohesion (psf)	Phi (deg)	Cohesion Type	Water Surface	Hu Type	Hu	Phi b (deg)	Air Entry (psf)
Saturated Sluiced Ash	Grey	90	Mohr-Coulomb	0	24		Water Surface	Custom	1	0	0
Fill	Yellow	125	Mohr-Coulomb	100	30		Water Surface	Custom	1	0	0
Upper Residuuum	Orange	125	Mohr-Coulomb	50	30		Water Surface	Custom	1	0	0
Lower Residuuum	Red	125	Mohr-Coulomb	100	30		Water Surface	Custom	1	0	0
Compacted Ash	Light Blue	110	Mohr-Coulomb	0	30		Water Surface	Custom	1	0	0
PWR	Brown	140	Undrained	10000		Constant	Water Surface	Custom	0	0	0

Method Name	Min FS
GLE / Morgenstern-Price	2.1

	SCALE	AS SHOWN	PROJECT	Closure Design - Plant McDonough AP-3/4	
	DATE	Jan 2018	TITLE	Section 3/4A-3/4A (North) Storage Pool	
	MADE BY	LJ			
	CAD	-			
FILE	STABILITY	CHECK	JGM	CLIENT	Georgia Power Company
PROJECT No.	1777449	REV.	0	REVIEW	GLH
				FIGURE	6(a)



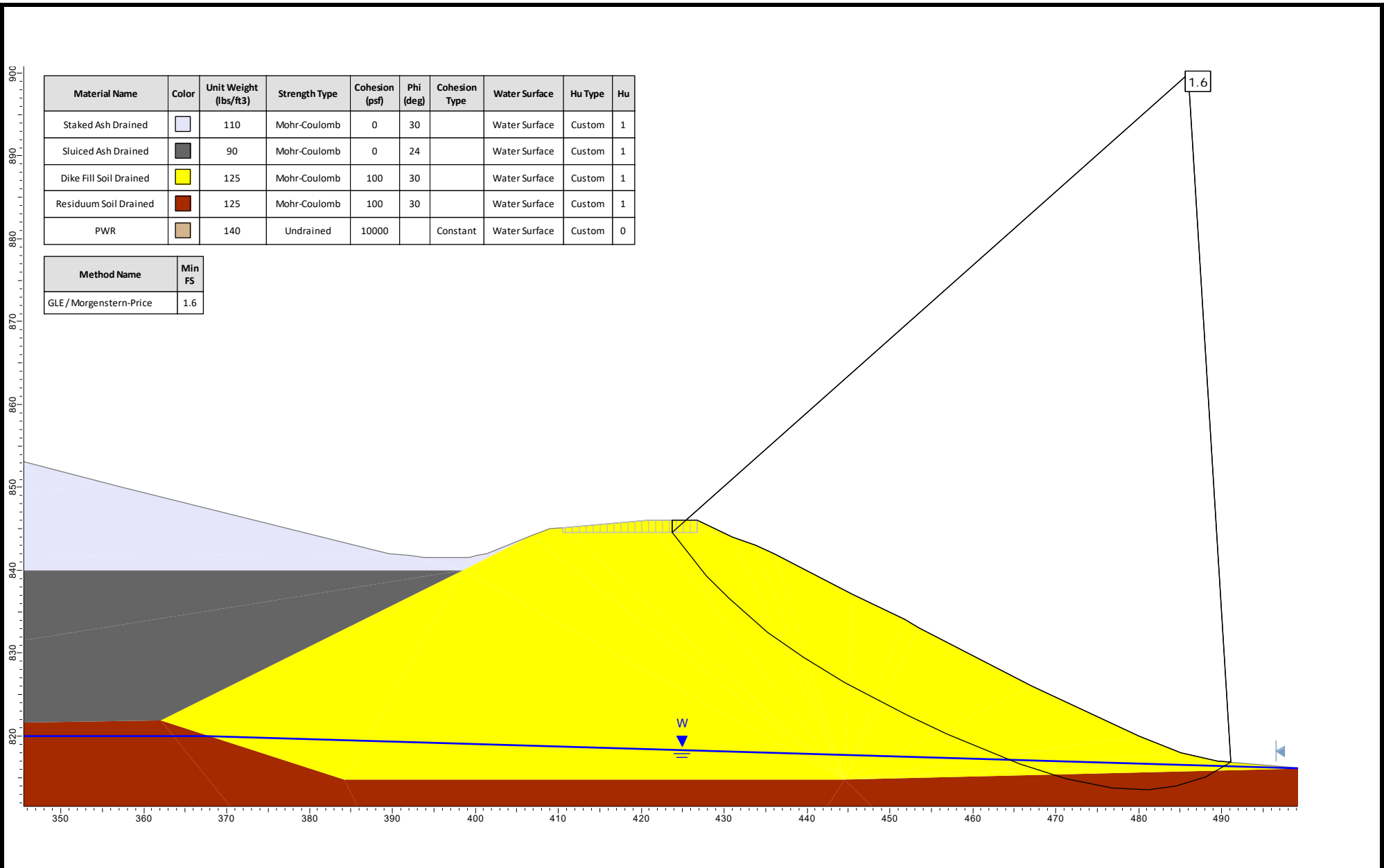
	SCALE	AS SHOWN	PROJECT	Closure Design - Plant McDonough AP-3/4	
	DATE	Jan 2018	TITLE	Section 3/4A-3/4A (North) Surcharge Pool	
	MADE BY	LJ	CLIENT	Georgia Power Company	
	CAD	-	FIGURE	6(b)	
FILE	STABILITY	CHECK	JGM		
PROJECT No.	1777449	REV.	0	REVIEW	GLH



Material Name	Color	Unit Weight (lbs/ft <sup>3</sup> )	Strength Type	Cohesion (psf)	Phi (deg)	Cohesion Type	Water Surface	Hu Type	Hu	Phi b (deg)	Air Entry (psf)
Saturated Sluiced Ash	Grey	90	Mohr-Coulomb	0	24		Water Surface	Custom	1	0	0
Fill	Yellow	125	Mohr-Coulomb	100	30		Water Surface	Custom	1	0	0
Upper Residuuum	Orange	125	Mohr-Coulomb	50	30		Water Surface	Custom	1	0	0
Lower Residuuum	Red	125	Mohr-Coulomb	100	30		Water Surface	Custom	1	0	0
Compacted Ash	Light Blue	110	Mohr-Coulomb	0	30		Water Surface	Custom	1	0	0
PWR	Brown	140	Undrained	10000		Constant	Water Surface	Custom	0	0	0

Method Name	Min FS
GLE/Morgenstern-Price	1.8

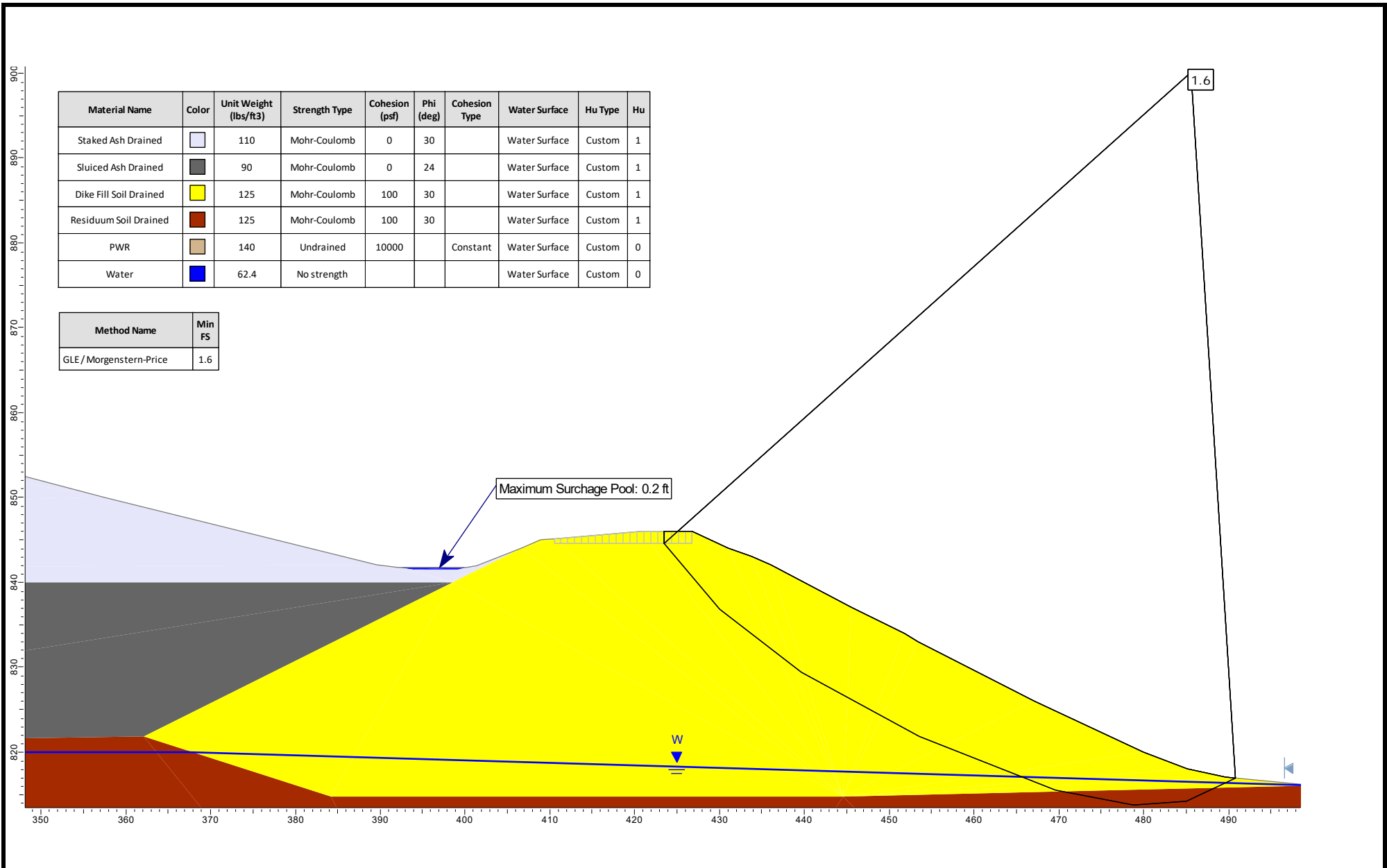
	SCALE	AS SHOWN	PROJECT	Closure Design - Plant McDonough AP-3/4	
	DATE	Jan 2018	TITLE	Section 3/4A-3/4A (North) Seismic Screening	
	MADE BY	LJ	CLIENT	Georgia Power Company	
	CAD	-	FIGURE	6(c)	
FILE	STABILITY	CHECK	JGM		
PROJECT No.	1777449	REV.	0	REVIEW	GLH



Material Name	Color	Unit Weight (lbs/ft <sup>3</sup> )	Strength Type	Cohesion (psf)	Phi (deg)	Cohesion Type	Water Surface	Hu Type	Hu
Staked Ash Drained		110	Mohr-Coulomb	0	30		Water Surface	Custom	1
Sluiced Ash Drained		90	Mohr-Coulomb	0	24		Water Surface	Custom	1
Dike Fill Soil Drained		125	Mohr-Coulomb	100	30		Water Surface	Custom	1
Residuum Soil Drained		125	Mohr-Coulomb	100	30		Water Surface	Custom	1
PWR		140	Undrained	10000		Constant	Water Surface	Custom	0

Method Name	Min FS
GLE / Morgenstern-Price	1.6

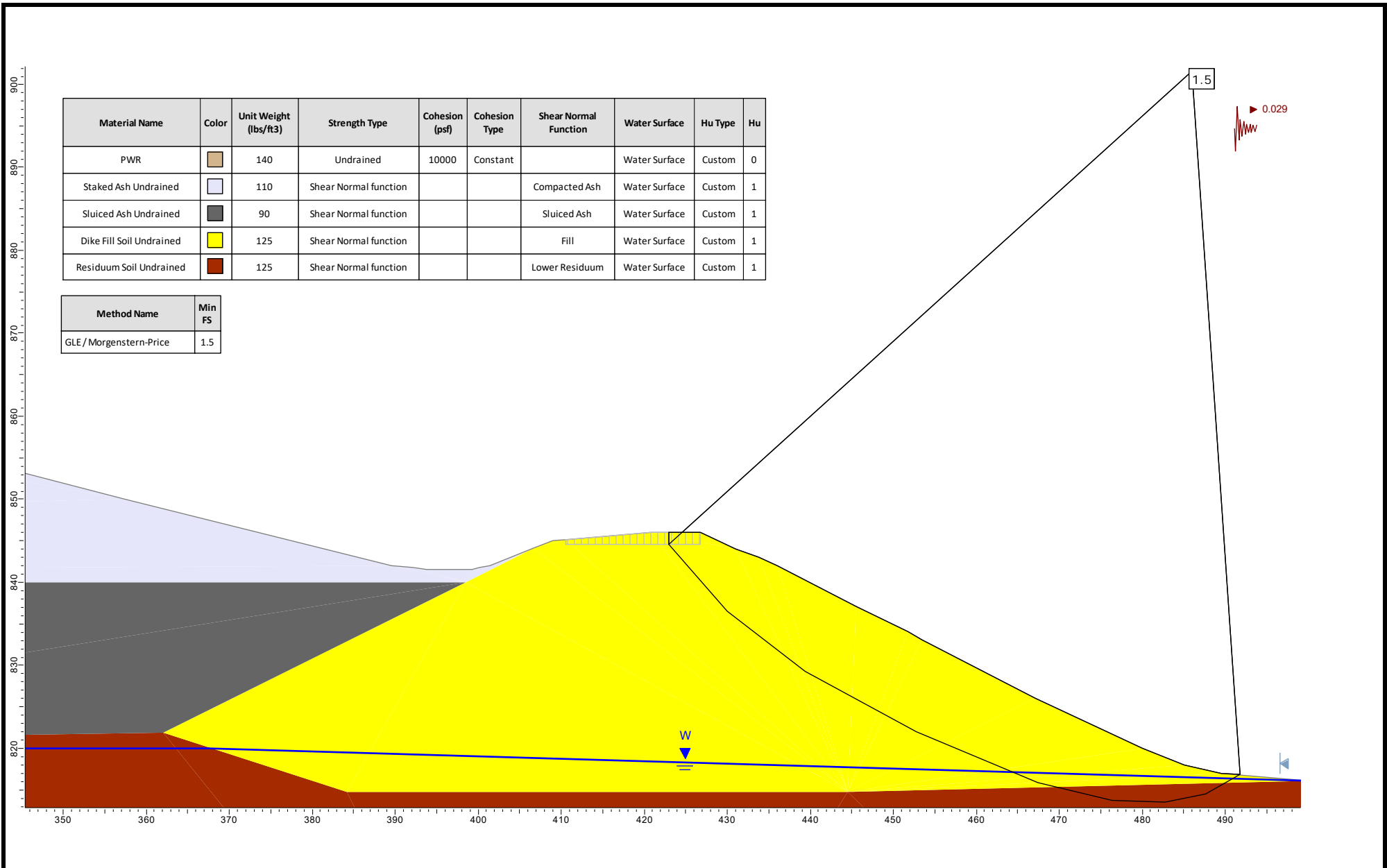
	SCALE	AS SHOWN	PROJECT	Closure Design - Plant McDonough AP-3/4	
	DATE	Jul 2018	TITLE	Section 3/4A-3/4A (South) Storage Pool	
	MADE BY	LJ			
	CAD	-			
FILE	STABILITY	CHECK	JGM	CLIENT	Georgia Power Company
PROJECT No.	1777449	REV.	0	REVIEW	GLH
				FIGURE	7(a)



Material Name	Color	Unit Weight (lbs/ft <sup>3</sup> )	Strength Type	Cohesion (psf)	Phi (deg)	Cohesion Type	Water Surface	Hu Type	Hu
Staked Ash Drained		110	Mohr-Coulomb	0	30		Water Surface	Custom	1
Sluiced Ash Drained		90	Mohr-Coulomb	0	24		Water Surface	Custom	1
Dike Fill Soil Drained		125	Mohr-Coulomb	100	30		Water Surface	Custom	1
Residuum Soil Drained		125	Mohr-Coulomb	100	30		Water Surface	Custom	1
PWR		140	Undrained	10000		Constant	Water Surface	Custom	0
Water		62.4	No strength				Water Surface	Custom	0

Method Name	Min FS
GLE / Morgenstern-Price	1.6

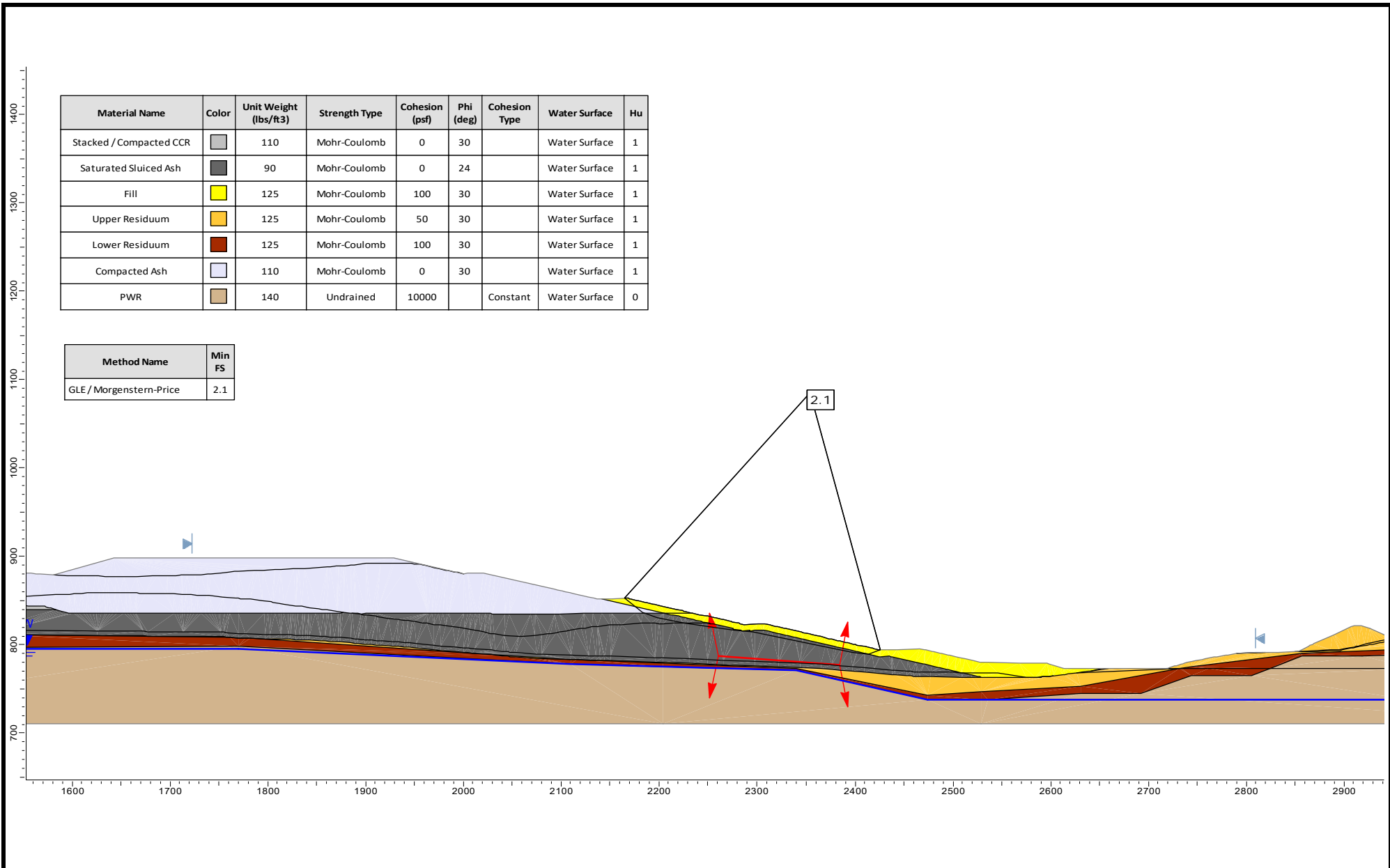
	SCALE	AS SHOWN	PROJECT	Closure Design - Plant McDonough AP-3/4	
	DATE	Jul 2018	TITLE	Section 3/4A-3/4A (South) Surcharge Pool	
	MADE BY	LJ	CLIENT	Georgia Power Company	
	CAD	-	FIGURE	7(b)	
FILE	STABILITY	CHECK	JGM		
PROJECT No.	1777449	REV.	0	REVIEW	GLH




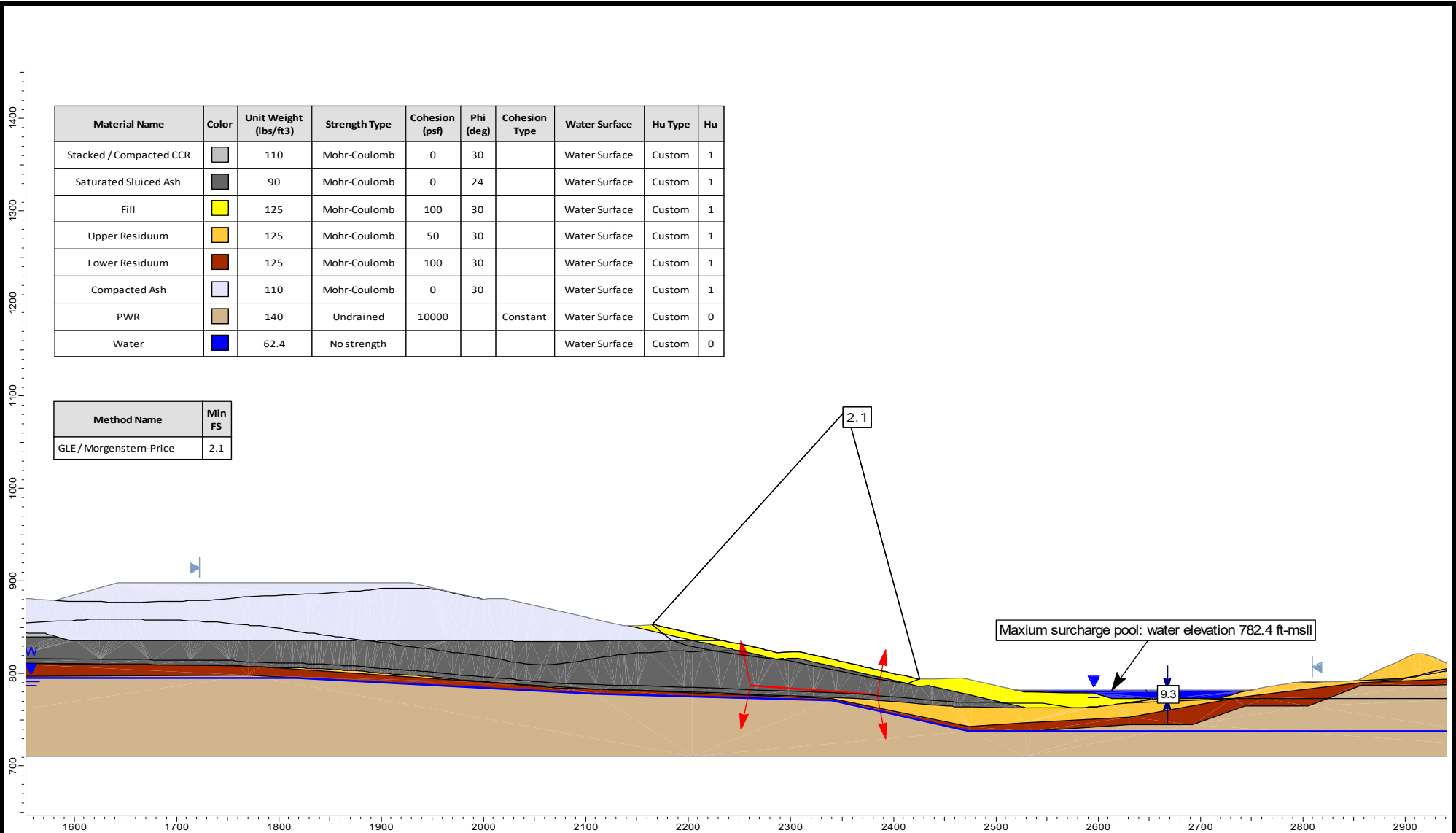
Material Name	Color	Unit Weight (lbs/ft <sup>3</sup> )	Strength Type	Cohesion (psf)	Cohesion Type	Shear Normal Function	Water Surface	Hu Type	Hu
PWR		140	Undrained	10000	Constant		Water Surface	Custom	0
Staked Ash Undrained		110	Shear Normal function			Compacted Ash	Water Surface	Custom	1
Sluiced Ash Undrained		90	Shear Normal function			Sluiced Ash	Water Surface	Custom	1
Dike Fill Soil Undrained		125	Shear Normal function			Fill	Water Surface	Custom	1
Residuum Soil Undrained		125	Shear Normal function			Lower Residuum	Water Surface	Custom	1


Method Name	Min FS
GLE/Morgenstern-Price	1.5

	SCALE	AS SHOWN	PROJECT	Closure Design - Plant McDonough AP-3/4	
	DATE	Jul 2018	TITLE	Section 3/4A-3/4A (South) Seismic Screening	
	MADE BY	LJ	CLIENT	Georgia Power Company	
	CAD	-	FIGURE	7(c)	
FILE	STABILITY	CHECK	JGM		
PROJECT No.	1777449	REVIEW	GLH		
REV.	0				

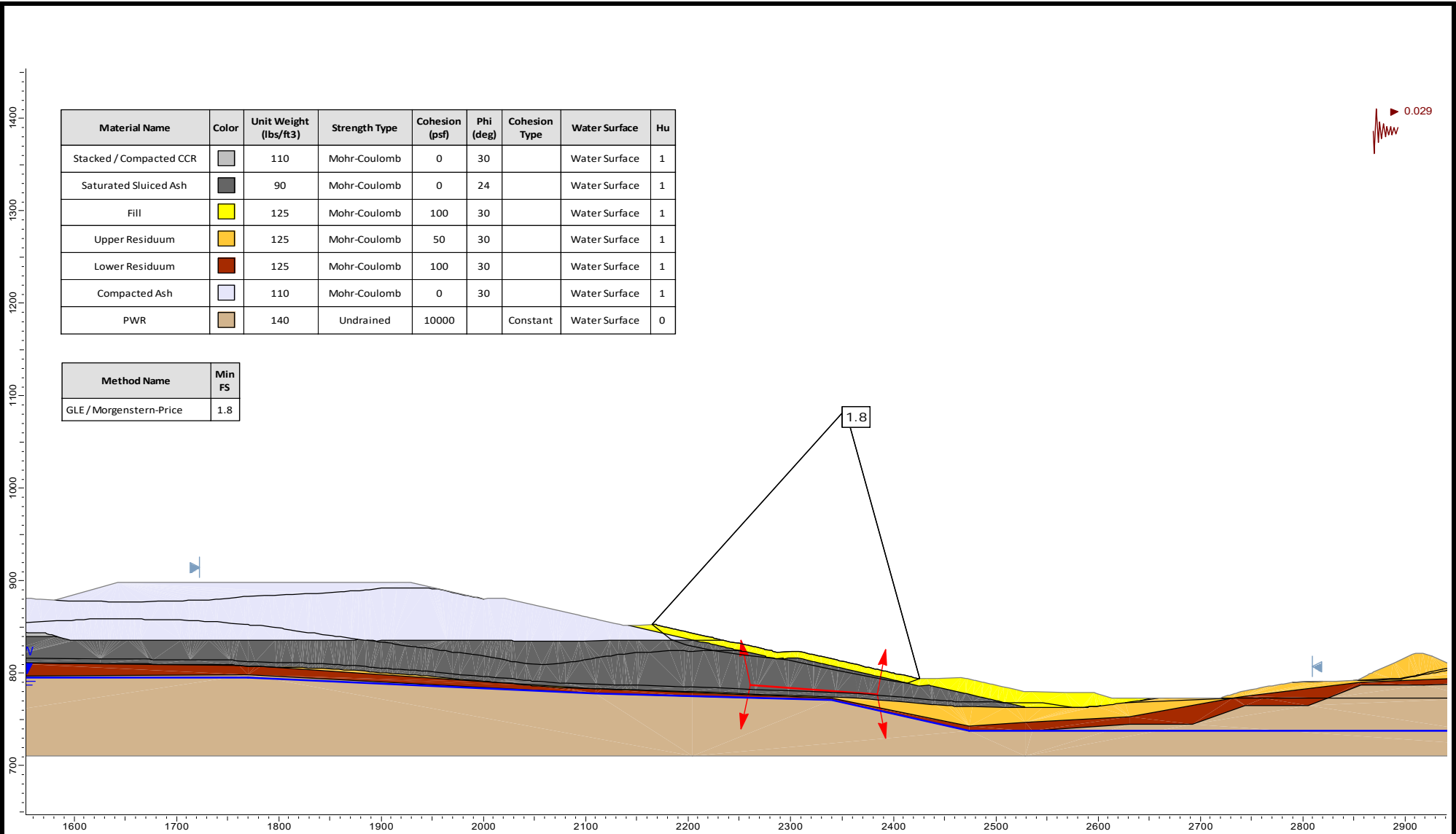



	SCALE	AS SHOWN	PROJECT	Closure Design - Plant McDonough AP-3/4	
	DATE	Jan 2018	TITLE	Section 3/4B-3/4B Storage Pool	
	MADE BY	LJ			
	CAD	-			
FILE	STABILITY	CHECK	JGM	CLIENT	Georgia Power Company
PROJECT No.	1777449	REV.	0	REVIEW	GLH
				FIGURE	8(a)

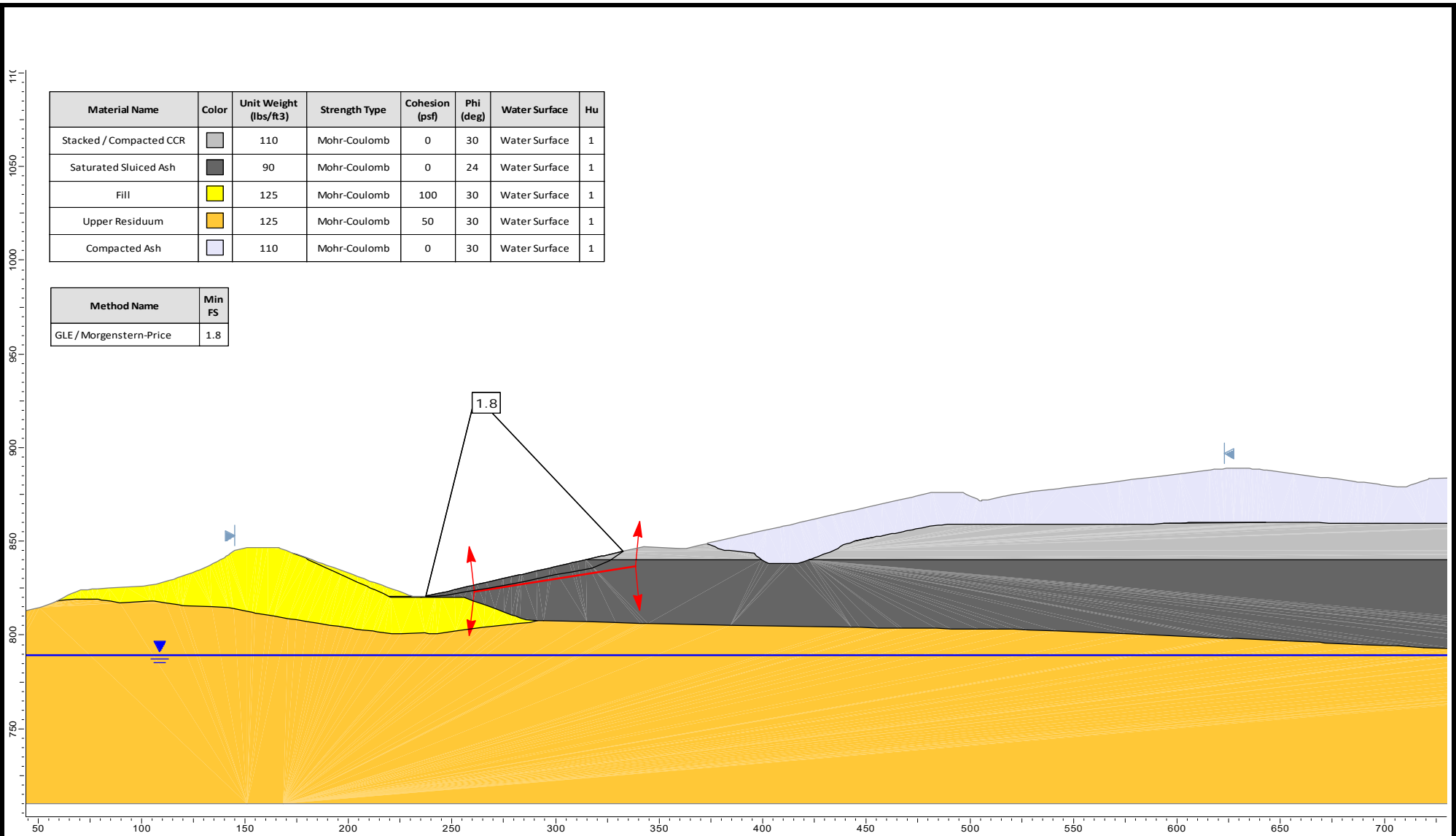



	SCALE	AS SHOWN	PROJECT	Closure Design - Plant McDonough AP-3/4	
	DATE	Jan 2018	TITLE	Section 3/4B-3/4B Surcharge Pool	
	MADE BY	LJ	CLIENT	Georgia Power Company	
	CAD	-	FIGURE	8(b)	
FILE	STABILITY	CHECK	JGM		
PROJECT No.	1777449	REV.	0	REVIEW	GLH

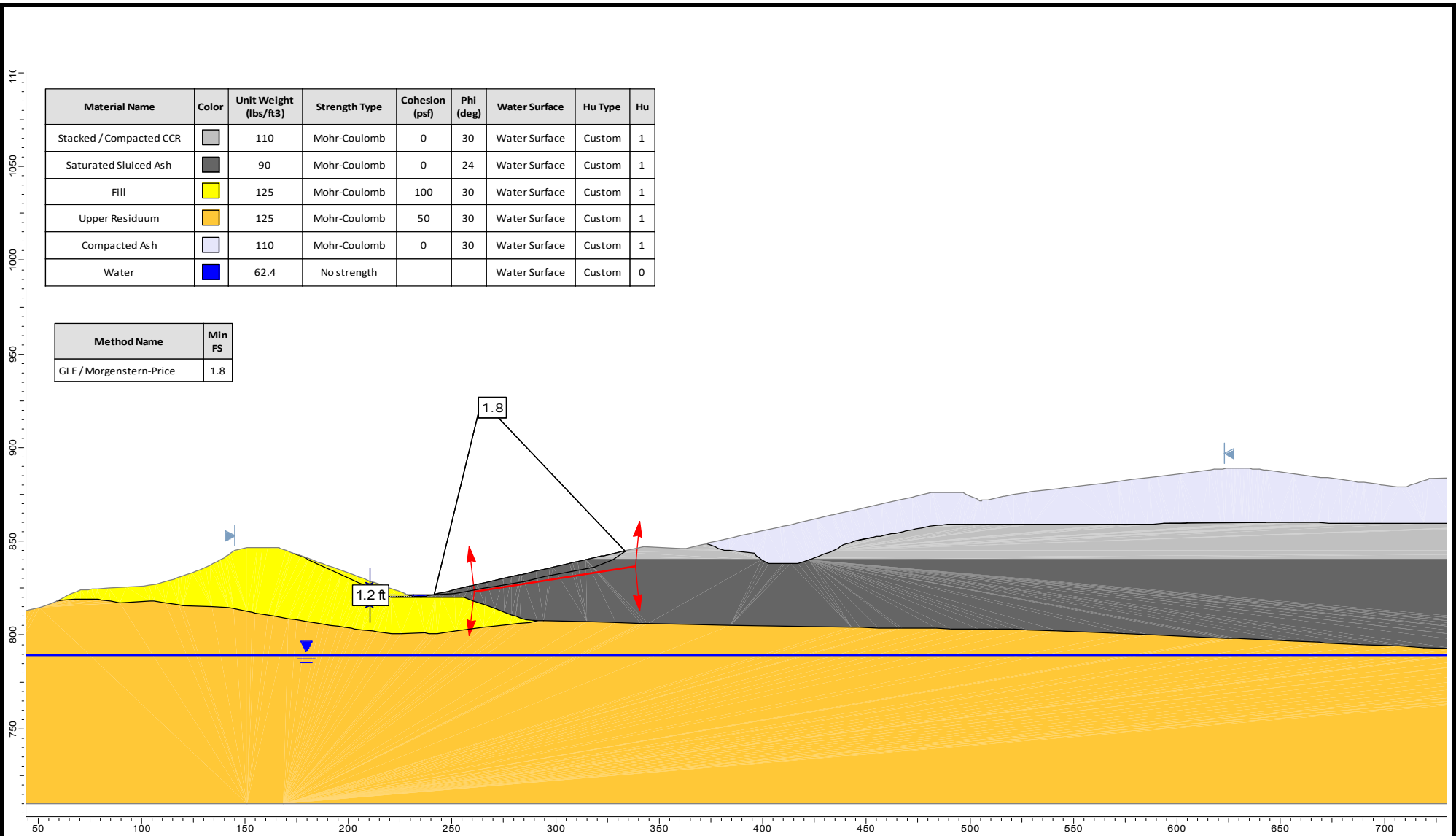





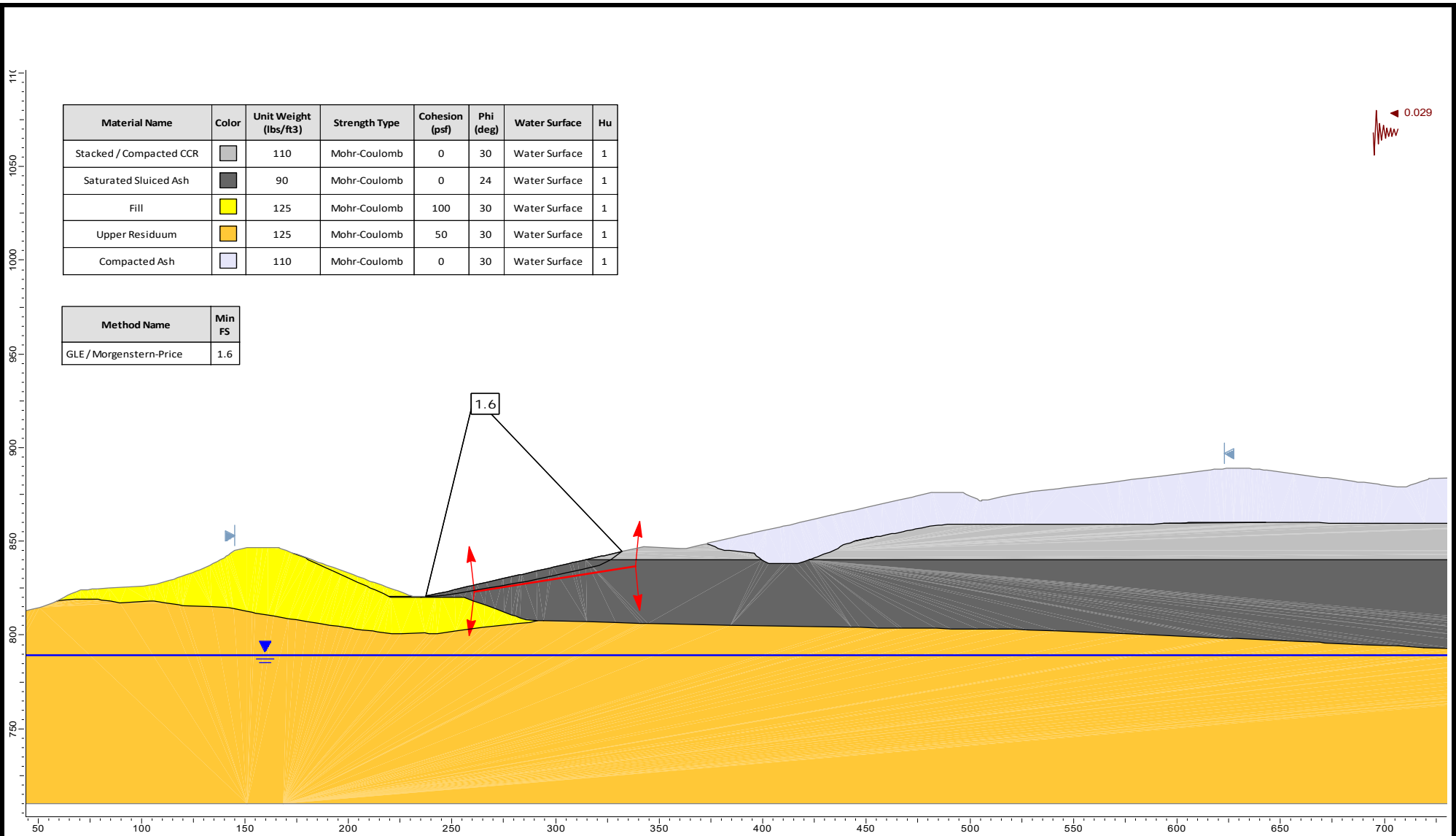
	SCALE	AS SHOWN	PROJECT	Closure Design - Plant McDonough AP-3/4	
	DATE	Jan 2018	TITLE	Section 3/4B-3/4B Seismic Screening	
	MADE BY	LJ			
	CAD	-			
FILE	STABILITY	CHECK	JGM	CLIENT	Georgia Power Company
PROJECT No.	1777449	REV.	0	REVIEW	GLH
				FIGURE	8(c)




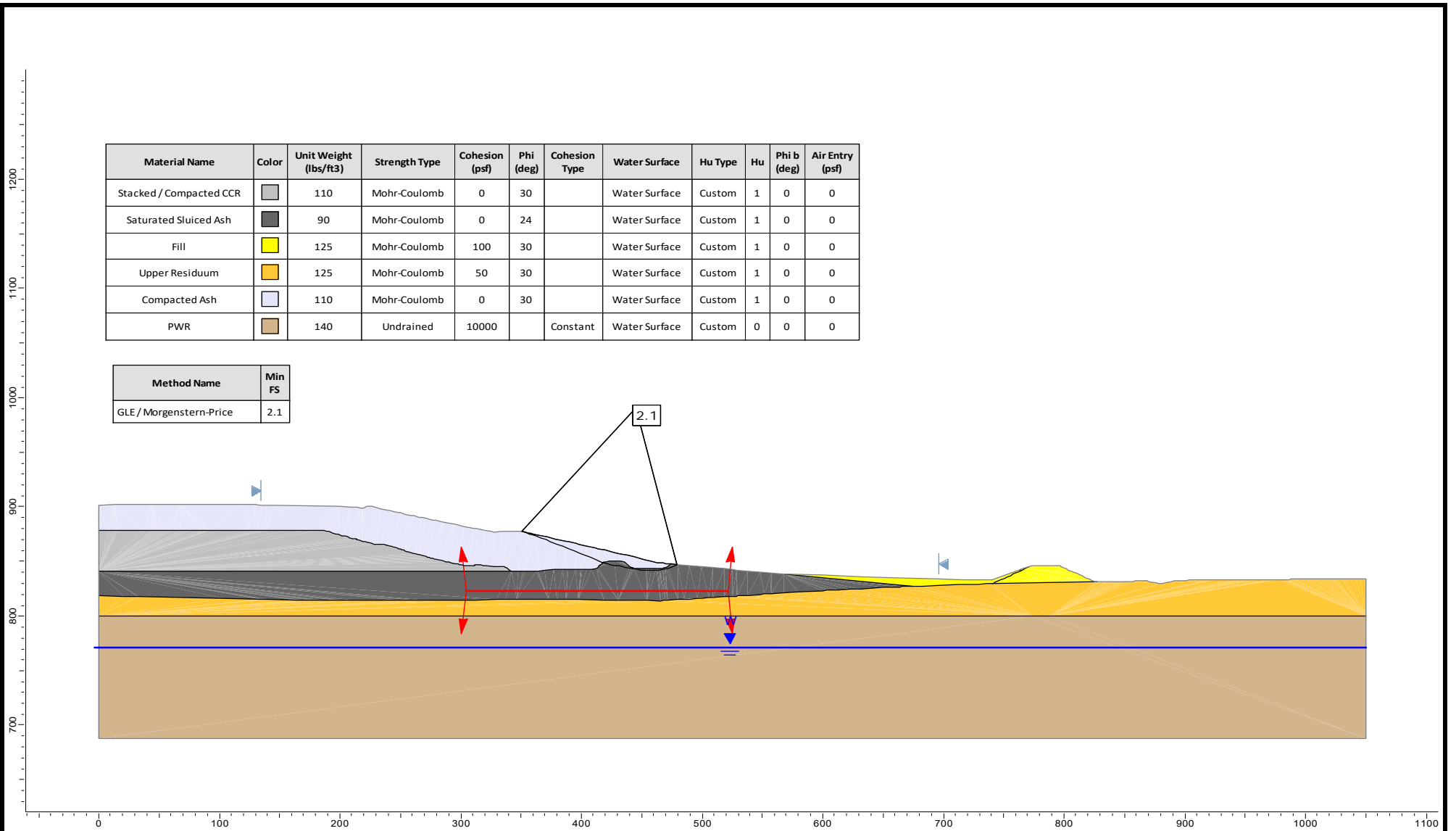
	SCALE	AS SHOWN	PROJECT	Closure Design - Plant McDonough AP-3/4	
	DATE	Jan 2018	TITLE	Section 3/4D-3/4D Storage Pool	
	MADE BY	LJ			
	CAD	-			
FILE	STABILITY	CHECK	JGM	CLIENT	Georgia Power Company
PROJECT No.	1777449	REV.	0	REVIEW	GLH
				FIGURE	9(a)




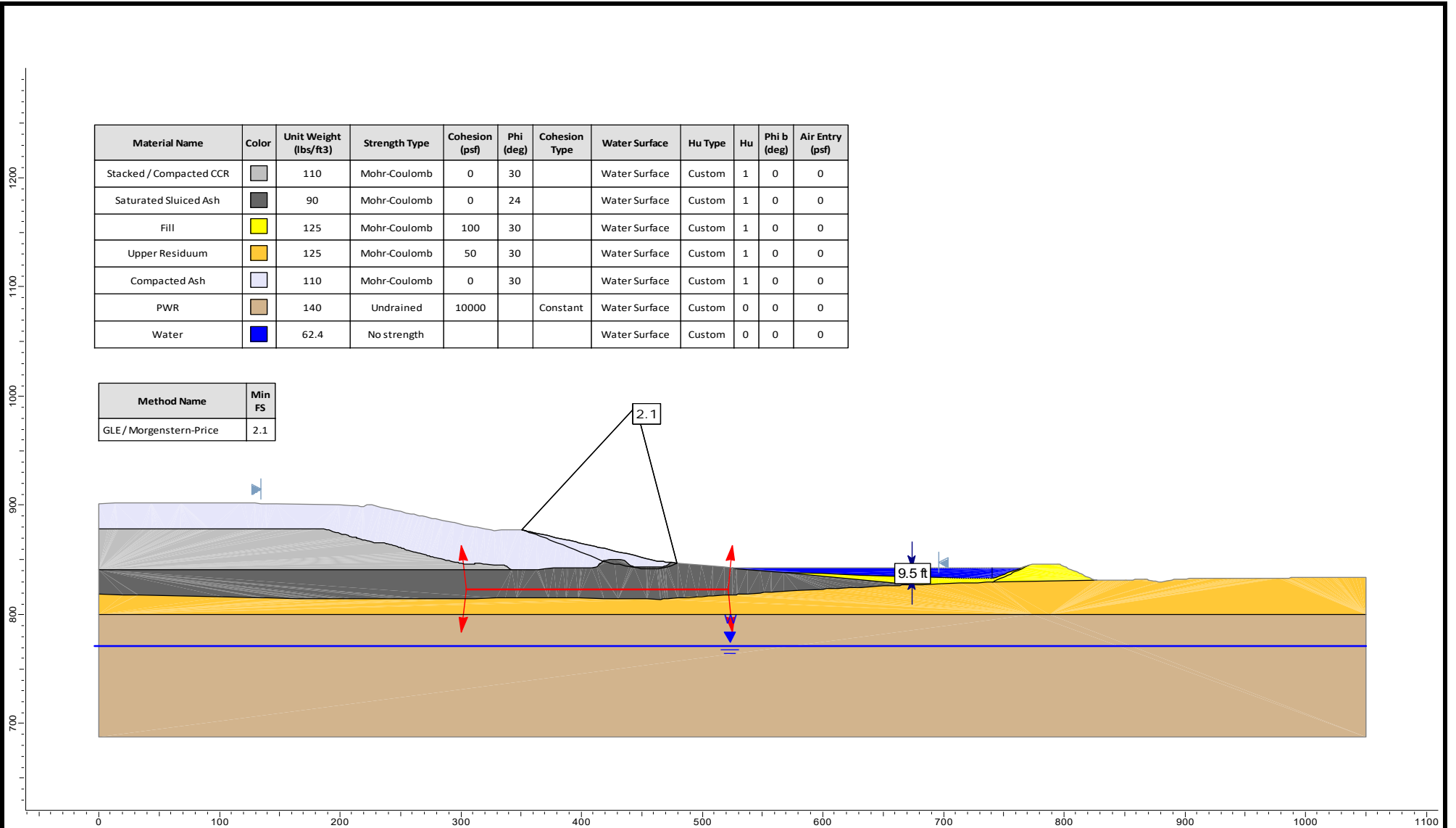
	SCALE	AS SHOWN	PROJECT	Closure Design - Plant McDonough AP-3/4	
	DATE	Jan 2018	TITLE	Section 3/4D-3/4D Surcharge Pool	
	MADE BY	LJ	CLIENT	Georgia Power Company	
	CAD	-	FIGURE	9(b)	
FILE	STABILITY	CHECK	JGM		
PROJECT No.	1777449	REV.	0	REVIEW	GLH




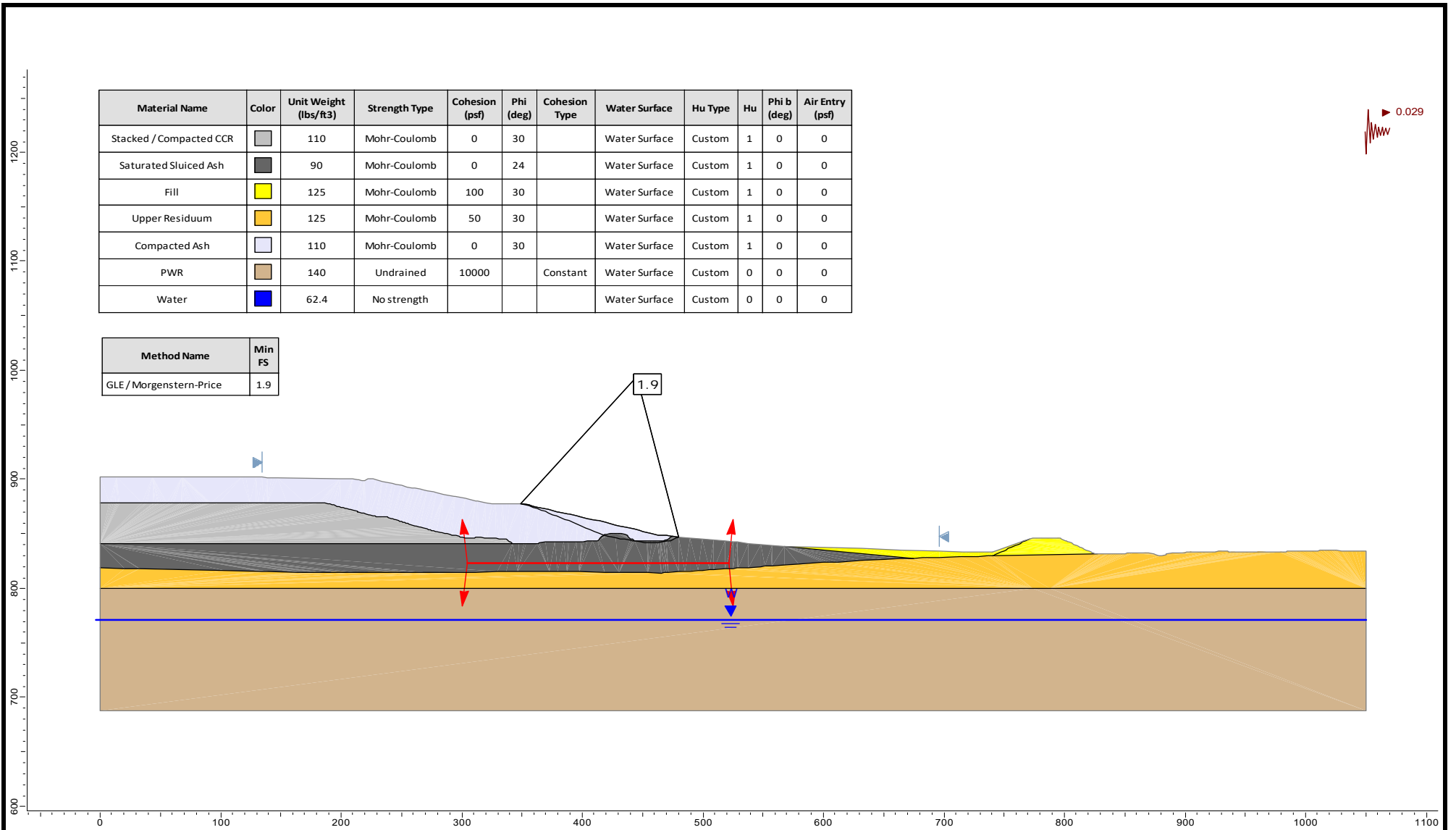
	SCALE	AS SHOWN	PROJECT	Closure Design - Plant McDonough AP-3/4	
	DATE	Jan 2018	TITLE	Section 3/4D-3/4D Seismic Screening	
	MADE BY	LJ			
	CAD	-			
FILE	STABILITY	CHECK	JGM	CLIENT	Georgia Power Company
PROJECT No.	1777449	REV.	0	REVIEW	GLH
				FIGURE	9(c)




	SCALE	AS SHOWN	PROJECT	Closure Design - Plant McDonough AP-3/4	
	DATE	Jan 2018	TITLE	Section 3/4J-3/4J Storage Pool	
	MADE BY	LJ			
	CAD	-			
FILE	STABILITY	CHECK	JGM	CLIENT	Georgia Power Company
PROJECT No.	1777449	REV.	0	REVIEW	GLH
				FIGURE	10(a)



	SCALE	AS SHOWN	PROJECT	Closure Design - Plant McDonough AP-3/4	
	DATE	Jan 2018	TITLE	Section 3/4J-3/4J Surchage Pool	
	MADE BY	LJ	CLIENT	Georgia Power Company	
	CAD	-	FIGURE	10(b)	
FILE	STABILITY	CHECK	JGM		
PROJECT No.	1777449	REV.	0		
		REVIEW	GLH		



	SCALE	AS SHOWN	PROJECT	Closure Design - Plant McDonough AP-3/4	
	DATE	Jan 2018	TITLE	Section 3/4J-3/4J Seismic Screening	
	MADE BY	LJ			
	CAD	-			
FILE	STABILITY	CHECK	JGM	CLIENT	Georgia Power Company
PROJECT No.	1777449	REV.	0	REVIEW	GLH
				FIGURE	10(c)

**APPENDIX C**

**Seismic Hazard Calculation  
Package**



## CALCULATIONS

**Date:** February 20, 2018

**Made by:** LJ

**Project No.:** 1777449

**Checked by:** JGM

**Subject:** Seismic Hazard Calculation

**Reviewed by:** GLH

### PROJECT: PLANT MCDONOUGH INACTIVE CCR SURFACE IMPOUNDMENTS

#### 1.0 OBJECTIVE

This calculation package identifies and summarizes the seismic hazard for the closed conditions of the inactive CCR surface impoundments AP-1, AP-2, and combined unit AP-3/4 at Plant McDonough-Atkinson (Plant McDonough), located at 84.476°W and 33.829°N. The seismic hazard is necessary for geotechnical design evaluations of stability under earthquake loading and liquefaction susceptibility.

#### 2.0 SEISMIC HAZARD SUMMARY

The United States Environmental Protection Agency's (EPA) "Disposal of Coal Combustion Residuals from Electric Utilities" Final Rule (40 C.F.R. Part 257 and Part 261) (CCR Rule) specifies seismic analyses be completed for a seismic event with a 2% probability of exceedance in 50 years (2% / 50yr), equivalent to a return period of approximately 2,500 years, based on the United States Geological Survey (USGS) seismic hazard maps. The USGS has provided online tools associated with this hazard for its 2014 seismic hazard model. The sections below detail the use of these tools to obtain seismic hazard data for use in analyses.

#### 3.0 PEAK GROUND AND SPECTRAL ACCELERATION

The peak ground acceleration (PGA) and spectral ground accelerations ( $S_a$ ) corresponding to a range of spectral periods are necessary for many engineering analyses including slope stability and liquefaction analyses. For a 2% probability of exceedance (PE) in 50 years, The USGS provides a reference PGA and spectral accelerations corresponding to a reference site on the border between the National Earthquake Reductions Hazard Program (NEHRP) site classes B and C with an average shear wave velocity in the upper 30 m ( $V_{s30}$ ) of 760 m/s. These reference accelerations are often referenced with a BC subscript (e.g.  $PGA_{BC}$ ) and are scaled as appropriate to match site conditions and analysis input requirements. Figure 1 below shows the project site on the 2014 seismic hazard map for  $PGA_{BC}$ , and Figure 2 displays the uniform hazard response spectrum curve, which plots the reference spectral acceleration, or ground motion, for various spectral periods. The uniform hazard response spectrum curve for the site is presented in tabular form in Table 1.

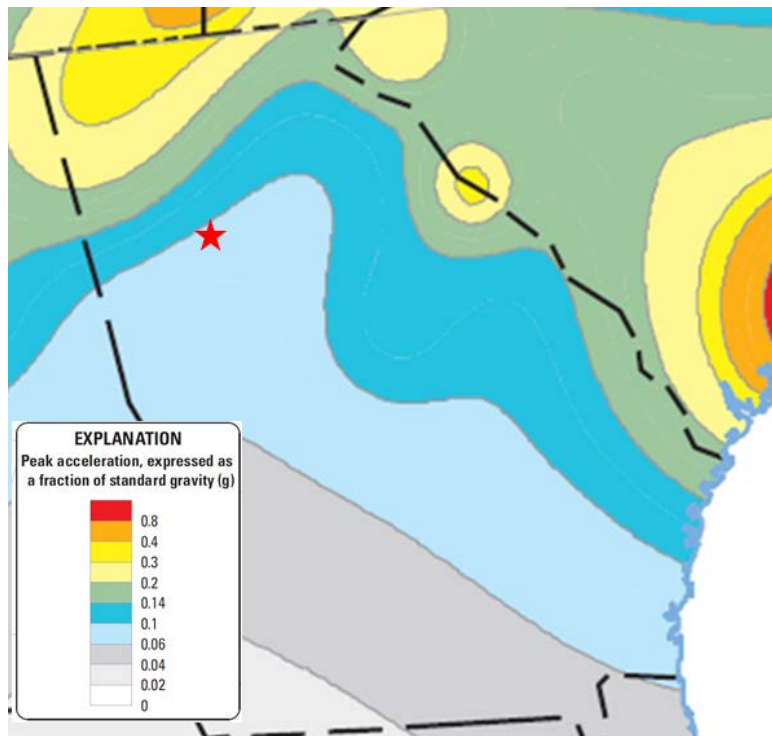


Figure 1: PGA(BC) for the 2% PE in 50 years at the project site (red star). (USGS 2014).

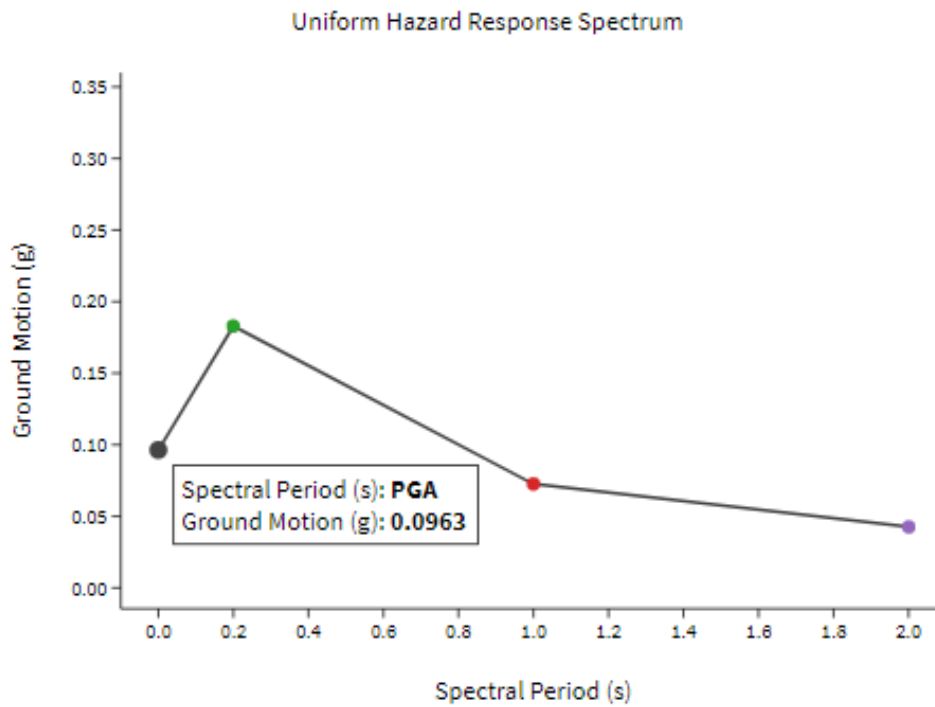


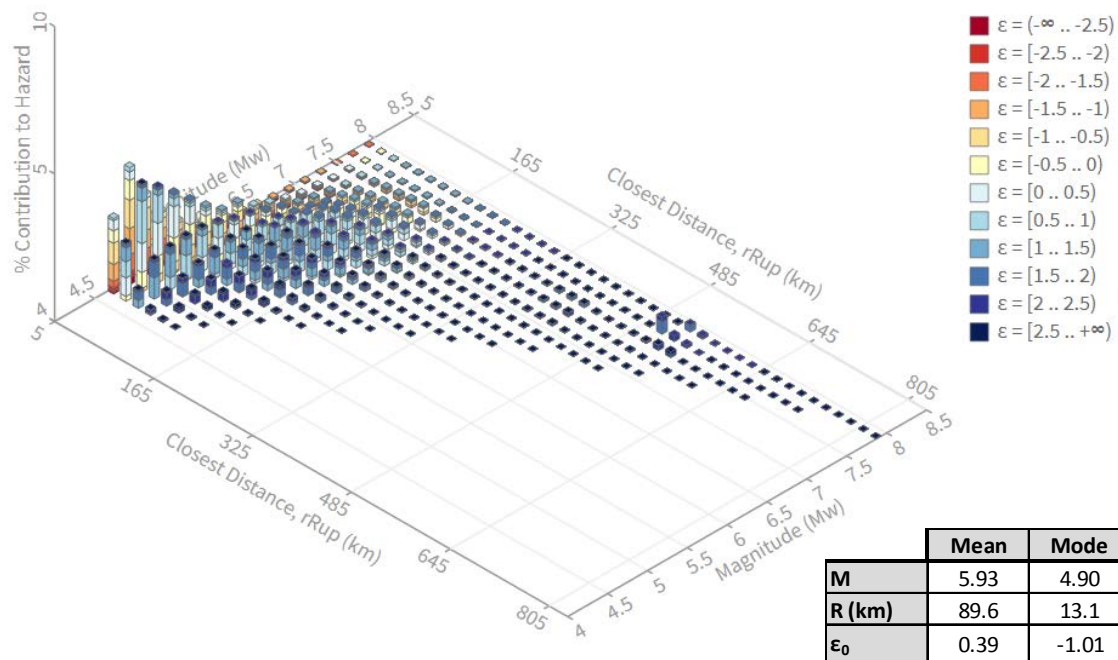
Figure 2: Uniform Hazard Response Spectrum for the 2% PE in 50 years Seismic Hazard at the Project Site (USGS 2014).

**Table 1: Reference Site (BC) PGA and Spectral Acceleration for The 2% PE in 50 Year Seismic Hazard at the Project Site (USGS 2014).**

Spectral Period (s)	Acceleration, BC (g)
0 (PGA)	0.0963
0.2	0.1829
1.0	0.0725
2.0	0.0426

### 3.1 Seismic Hazard Deaggregation

The seismic hazard is compiled from multiple predictive models which consider many seismic sources of varying combinations of earthquake magnitude and distance from the project site. For each magnitude and distance pair, models predict the resulting accelerations and activity rates for the project site. The results of these predictive models are aggregated to produce the seismic hazard model for specified return periods. The seismic hazard model can be deaggregated to obtain the contribution to hazard percentage of magnitude and distance combinations. This information is necessary for analyzes requiring earthquake magnitude (e.g. liquefaction susceptibility) or distance. Figure 3 below displays a deaggregation plot of the  $PGA_{BC}$  at the project site for a 2% PE in 50 years with descriptive statistics available through the USGS online tools.



**Figure 3: Deaggregation Plot of the  $PGA_{BC}$  at the Project Site for a 2% PE in 50 Years**

### 3.2 Design Earthquake Magnitude

Some seismic analysis methods require a design earthquake magnitude as an input. One such analysis is the liquefaction screening method. While the probabilistic seismic hazard tool provided by the USGS (discussed above) gives a design PGA and deaggregated magnitude and distance pairs for all sources contributing to the earthquake hazard, a design magnitude is not explicitly provided by the tool.

The selection of either the mean or modal magnitude produces inconsistent results for some analyses. Specifically, liquefaction assessments based on a design earthquake magnitude and ground acceleration are particularly sensitive to this selection because the relationship between duration (represented by magnitude) and liquefaction potential is non-linear. Kramer (2008) suggests that the best way to handle this issue is to perform liquefaction calculations for a series of realistic site magnitudes and to weight the results according to the relative contribution of each magnitude to the probabilistic seismic hazard (provided in the USGS tools).

Golder implemented this approach in the liquefaction analysis. Recognizing that the Magnitude Scaling Factor (MSF) is the only magnitude-dependent term in the simplified NCEER approach (Youd et al. 2001), Golder calculated a weighted-average MSF (weighted by the relative contribution of each magnitude), and then calculated the magnitude corresponding to that MSF.

Golder calculated the design earthquake magnitude to be 5.75 and was used in all seismic analyses requiring a design magnitude for consistency. As is typical, the design earthquake magnitude (5.75) fell between the mean magnitude (5.93) and modal magnitude (4.90) provided in Figure 3.

### 4.0 DETERMINATION OF SITE-SPECIFIC PEAK GROUND ACCELERATION

For liquefaction analysis, the site-specific peak ground acceleration at the surface,  $a_{max}$ , was calculated from the site reference peak ground acceleration ( $PGA_{BC}$ ). The  $PGA_{BC}$  value was multiplied by an amplification factor calculated from the average shear wave velocity in the upper 30 meters ( $Vs30$ ) to obtain a representative  $a_{max}$ . The shear wave velocity was directly measured every two meters in CPT-10-AP3, and a representative shear wave velocity was derived from these measurements. Figure 4 shows the measured shear wave velocities and the representative shear wave velocity profile. The  $Vs30$  (listed in Table 2) was calculated from the representative profile to be 621 ft/s.

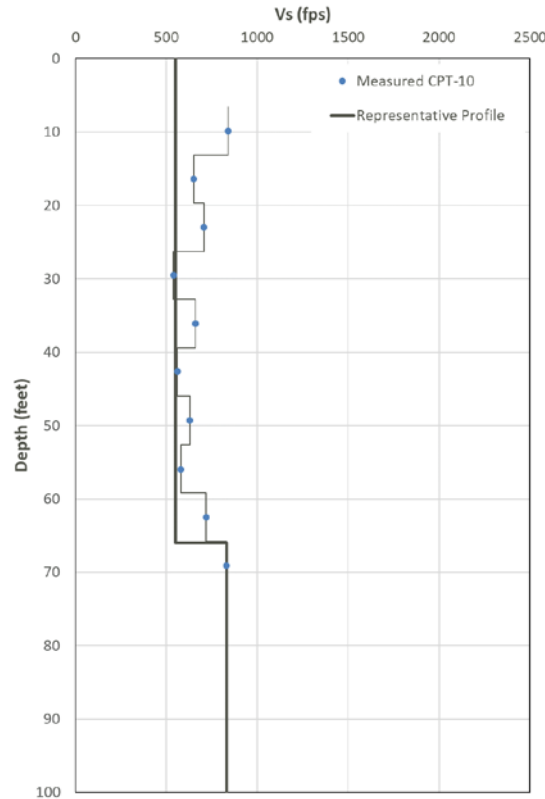


Figure 4. Representative shear wave velocity profile for Plant McDonough CCR Surface Impoundments

Table 2: Representative Shear Wave Velocity in the Upper 30 m (Vs30)

Pond ID	Vs30 (ft/s)	Vs30 (m/s)
AP-1, AP-2 & AP-3/4	621	189

#### 4.1 Determination of site amplification factor coefficient $F_a$

An amplification factor was determined from two sources:

- a) Atkinson and Boore’s 2006 publication on earthquake ground-motion prediction equations for Eastern North America
- b) International Building Code (IBC, 2012)

Atkinson and Boore’s publication provides a site response term which is used to amplify the  $PGA_{BC}$ , and the IBC provides a site coefficient  $F_a$  (amplification factor) as well. While the IBC factor was originally developed for buildings, the IBC amplification factor was calculated as a check on the Atkinson and Boore method. Amplification factors from these two sources were averaged to obtain a representative amplification factor.

**Table 3: Site coefficient  $F_a$** 

Pond ID	Atkinson and Boore (2006)	IBC (2012)	Selected for Analysis
AP-1, AP-2, & AP-3/4	1.71	1.6	1.66

#### 4.2 Site-specific peak ground acceleration $a_{max}$

$$a_{max} = PGA_{BC} * F_a = 0.0963g * 1.66 = 0.16g \quad (1)$$

With a proposed site coefficient  $F_a$  of 1.66, Golder calculated the amplified site-specific peak ground acceleration  $a_{max}$  to be 0.16 g.

**Table 4:  $a_{max}$  at AP-1, AP-2, & AP-3/4**

Pond ID	Site Specific Amplified PGA $a_{max}$
AP-1, AP-2, & AP-3/4	0.16 g

### 5.0 PSEUDOSTATIC COEFFICIENT – SEISMIC SLOPE STABILITY ANALYSIS

For slope stability analyses, Golder used the Bray and Travararou (2009) screening method which models seismic loading using a pseudostatic coefficient (k). This section details the calculation of the pseudostatic coefficient for the project site. Details on the slope stability analysis are available in the Safety Factor Assessment package for the facility units.

Stability under seismic conditions is calculated using the pseudostatic method to model horizontal seismic forces as the product of a seismic coefficient (k) and the weight of the sliding mass. Bray and Travararou (2009) proposed screening methodology to determine the seismic coefficient k based on the degraded period of the sliding mass and an allowable seismic displacement threshold. The screening method includes an equation to calculate the pseudostatic coefficient for periods of 0.2 and 0.5 seconds, which encompasses the range of typical slope periods. A period of 0.2 s produces a more conservative coefficient, so for this analysis, Golder used the equation associated with a period of 0.2 s and an allowable seismic displacement of 15 cm:

$$k_{15cm} = (0.036M_w - 0.004)S_a - 0.030 > 0.0, \text{ for } S_a = S_a(T = 0.2s) < 2.0g \quad (2)$$

Where,  $k_{15cm}$  = pseudostatic coefficient

$M_w$  = Design Earthquake Magnitude

$S_a$  = Spectral acceleration at the base of the sliding mass

As noted in Section 3.0, the BC spectral acceleration at a period of 0.2 s is 0.1829 g. This value is multiplied by an amplification factor to obtain the acceleration at the base of the sliding mass. Golder used an amplification factor of 1.6 as prescribed by the international building code (IBC 2012) for a site class D. The project site was classified as D according to the representative shear wave velocity in the upper 30 meters or 100 feet ( $V_{s30}$ ). Thus, the spectral acceleration  $S_a$  used in the equation is 0.293 g (0.1829g x 1.6). The pseudostatic coefficient was calculated to be 0.029 g as shown in Table 5.

**Table 5:  $k_{15\text{ cm}}$  at AP-1, AP-2, & AP-3/4**

Pond ID	$k_{15\text{ cm}}$
AP-1, AP-2, & AP-3/4	0.029 g

## 6.0 REFERENCE

- Atkinson, G.M. and D.M. Boore (2006) "Earthquake Ground-Motion Prediction Equations for Eastern North America," Bulletin of the Seismological Society of America, Vol. 96, No. 6, pp. 2181-2205.
- Bray, J.D., and Travasarou, T. (2009). Pseudostatic Coefficient for Use in Simplified Seismic Slope Stability Evaluation. Journal of Geotechnical and Geoenvironmental Engineering, Vol. 135, No. 9: pp. 1336-1340.
- Kramer, S.L. (2008). "Evaluation of Liquefaction Hazards in Washington State" Final Research report WA-RD 668.1, December 2008.
- Richardson, G. and E. Kavazanjian. 1995. RCRA Subtitle D (258): Seismic Design Guidance for Municipal Solid Waste Landfill Facilities. U.S. Environmental Protection Agency, Washington, D.C., EPA/600/R-95/051.
- International Code Council, Inc. (2012), "2012 International Building Code", Section 1613.3
- United States Geologic Survey (2018), Unified Hazard Tool. Accessed January 9, 2018. <https://earthquake.usgs.gov/hazards/interactive/>.
- Youd, T.L. et al. (2001). "Liquefaction Resistance of Soils: Summary Report from the 1996 NCEER and 1998 NCEER/NSF workshops on Evaluation of Liquefaction Resistance of Soils", Journal of Geotechnical and Geoenvironmental Engineering, vol. 127, No. 4, April 2001.

**APPENDIX D**

**Liquefaction Assessment  
Calculation Package**



## CALCULATIONS

**Date:** February 20, 2018

**Made by:** LJ

**Project No.:** 1777449

**Checked by:** JGM

**Subject:** Liquefaction Assessment

**Reviewed by:** GLH

### PROJECT: PLANT MCDONOUGH INACTIVE CCR SURFACE IMPOUNDMENTS AP-2 AND COMBINED UNIT AP-3/4

#### 1.0 OBJECTIVE

The objective of this calculation is to assess the liquefaction potential of the foundation soils and dikes surrounding inactive CCR surface impoundments AP-2, AP-3, and AP-4 at Georgia Power Company (Georgia Power's) Plant McDonough-Atkinson (Plant McDonough). Liquefaction potential is assessed for the final closure condition of these ponds. In the closure condition, AP-3 and AP-4 are consolidated into a single unit; thus, these ponds will be further referenced as combined unit AP-3/4.

This liquefaction assessment uses the screening-level assessment described in Youd et al. (2001). Cone Penetration Test (CPT) data is used to characterize soils for this assessment with updates suggested by Robertson (2009).

#### 2.0 METHODOLOGY

Seismically-induced liquefaction susceptibility was evaluated using the National Center for Earthquake Engineering Research (NCEER) simplified procedure with CPT data (Youd et al., 2001). The simplified procedure is an empirical method used to calculate the factor of safety against liquefaction. The factor of safety is defined as a ratio of the cyclic resistance ratio (CRR) to the cyclic stress ratio (CSR). The CRR is a measure of a soils' resistance to liquefaction and was estimated using CPT data. The CSR is a measure of the seismic demand on the soil and was estimated using seismic hazard assessment resources provided by the United States Geologic Survey (USGS) as described in Golder's Seismic Hazard Calculation Package.

Factors of safety against liquefaction were calculated for six CPT soundings representative of the foundation soils and dikes of AP-2 and AP-3/4. Specifically, the following CPTs were analyzed:

- CPT-02-DAM
- CPT-04-DAM
- CPT-07-DAM
- CPT-10-AP3
- CPT-30-AP4
- CPT-44-AP4

Materials which are dry are not susceptible to liquefaction. Thus, Golder did not calculate the factor of safety against liquefaction for the CCR materials impounded in AP-3/4 since these materials are modelled to be dry in the long term due to dewatering efforts and engineering controls. While these efforts will likely dry large portions of the dike and foundation soils, the extent of drying in the dike and foundation soils was not estimated. Therefore, Golder calculated factors of safety for all dike and foundation soils measured by the CPTs to be conservative.

## 2.1 CSR Determination

The CSR is defined as:

$$CSR = \frac{\tau_{ave}}{\sigma'_v} = 0.65 \left( \frac{a_{max}}{g} \right) \left( \frac{\sigma_v}{\sigma'_v} \right) r_d$$

where  $a_{max}$  is the peak horizontal acceleration at the ground surface,  $g$  is the acceleration due to gravity,  $\sigma_v$  is the total vertical overburden stress,  $\sigma'_v$  is the effective vertical overburden stress, and  $r_d$  is a depth-dependent stress reduction factor defined as:

$$r_d = 1.0 - 0.00765z \quad \text{for } z \leq 9.15 \text{ m}$$

$$r_d = 1.174 - 0.0267z \quad \text{for } 9.15 \text{ m} < z \leq 23 \text{ m}$$

$$r_d = 0.744 - 0.008z \quad \text{for } 23 \text{ m} < z \leq 30 \text{ m}$$

$$r_d = 0.50 \quad \text{for } z > 30 \text{ m}$$

where  $z$  is the depth in meters (m). The determination of the  $a_{max}$  value is provided in the Golder's Seismic Hazard Calculation Package.

## 2.2 CRR Determination

The second major step in assessing the liquefaction susceptibility using the simplified approach is to estimate the CRR. Robertson and Wride (1998) developed the procedure for calculating CRR from the CPT as a function of the "clean sand" cone penetration resistance normalized to 1 atmosphere (atm; approximately 100 kilopascals; kPa) and given as  $(q_{c1N})_{cs}$ . The CRR is based on an earthquake magnitude of 7.5, and a magnitude scaling factor (MSF) adjusts the CRR for magnitudes other than 7.5.

The CRR for an earthquake magnitude ( $M$ ) of 7.5 is given as:

$$(q_{c1N})_{cs} < 50 \quad CRR_{7.5} = 0.833 \left[ \frac{(q_{c1N})_{cs}}{1000} \right] + 0.05$$

$$50 \leq (q_{c1N})_{cs} < 160 \quad CRR_{7.5} = 93 \left[ \frac{(q_{c1N})_{cs}}{1000} \right]^3 + 0.08$$

where  $(q_{c1N})_{cs}$  is the clean sand cone penetration resistance normalized to 1 atm (approximately 100 kPa or 1 ton per square foot; tsf).

The tip resistance ( $q_c$ ) is normalized to obtain  $q_{c1N}$  as:

$$q_{c1N} = C_Q \left( \frac{q_c}{P_a} \right)$$

$$C_Q = \left( \frac{P_a}{\sigma'_{vo}} \right)^n$$

where  $C_Q$  is the normalizing factor for cone penetration resistance,  $P_a$  is 1 atm of pressure,  $n$  is an exponent that is dependent on the soil type, and  $q_c$  is the cone tip penetration resistance ( $q_c$  is replaced by  $q_t$ , the cone tip resistance corrected for geometric impacts of the pore pressure measurement in all instances).

The method adopted in this assessment calculates the exponent,  $n$ , according to a method developed by Robertson (2009) and represents a small modification to the standard NCEER approach. The exponent,  $n$ , is calculated as:

$$n = 0.381I_c + 0.05 \left( \frac{\sigma'_{vo}}{P_a} \right) - 0.15 \leq 1.0$$

where

$$I_c = [(3.47 - \log Q_{t1})^2 + (1.22 + \log F_r)^2]^{0.5}$$

$$Q_{t1} = \left[ \frac{q_c - \sigma_{vo}}{\sigma'_{vo}} \right]$$

$$F_r = \left[ \frac{f_s}{q_c - \sigma_{vo}} \right] \times 100\%$$

### 2.2.1 Clean Sand Equivalent Cone Penetration Resistance ( $q_{c1N}$ )<sub>cs</sub>

According to the NCEER approach, the presence of fines affects the liquefaction resistance of soils. A correction factor,  $K_c$ , is applied to the normalized penetration resistance ( $q_{c1N}$ ) to determine the clean sand equivalent ( $q_{c1N}$ )<sub>cs</sub> where:

$$(q_{c1N})_{cs} = K_c q_{c1N}$$

$$\text{for } I_c \leq 1.64 \quad K_c = 1.0$$

$$\text{for } I_c > 1.64 \quad K_c = -0.403I_c^4 + 5.581I_c^3 - 21.63I_c^2 + 33.75I_c - 17.88$$

Note that in the case of CCR materials the clean sand correlation is not conservative, and in cases of applying this approach to CCR materials a modified factor is used by Golder to be more conservative.

### 2.2.2 Magnitude Scaling Factor (MSF)

The magnitude scaling factor (MSF) adjusts the CRR for magnitudes other than 7.5 (Youd et al. 2001) where the factor of safety against liquefaction is calculated as

$$FS = \frac{CRR_{7.5}}{CSR} \times MSF$$

A number of different MSF values are discussed in the NCEER approach. The MSF values used in this assessment are the revised Idriss values (which are considered a lower bound set of values), and are calculated as:

$$MSF = \frac{10^{2.24}}{M^{2.56}}$$

Where M is the design earthquake magnitude (5.75, see more details in Seismic Hazard Calculation Package).

### 2.3 Factor of Safety Against Liquefaction

The factor of safety was calculated as:

$$FS = \frac{CRR_{7.5}}{CSR} \times MSF$$

The factor of safety was calculated for every recorded depth reading in each CPT. Liquefaction calculations for each CPT including the calculated factors of safety are graphically presented in the figures attached to the end of this text.

## 3.0 RESULTS AND CONCLUSIONS

The United States Environmental Protection Agency's (EPA) "Disposal of Coal Combustion Residuals from Electric Utilities" Final Rule (40 C.F.R. Part 257 and Part 261) (CCR Rule) specifies a required factor of safety of 1.2 against liquefaction for pond impoundment structures (§257.73(e)(iv)). The dikes and foundation soils at AP-2 and AP-3/4 meet this requirement as all calculated factors of safety against liquefaction for these materials are greater than 1.2 in all CPT soundings analyzed. CCR materials impounded in AP-3/4 were not analyzed for liquefaction susceptibility since these materials will be dry in the long term and, thus, not susceptible to liquefaction.

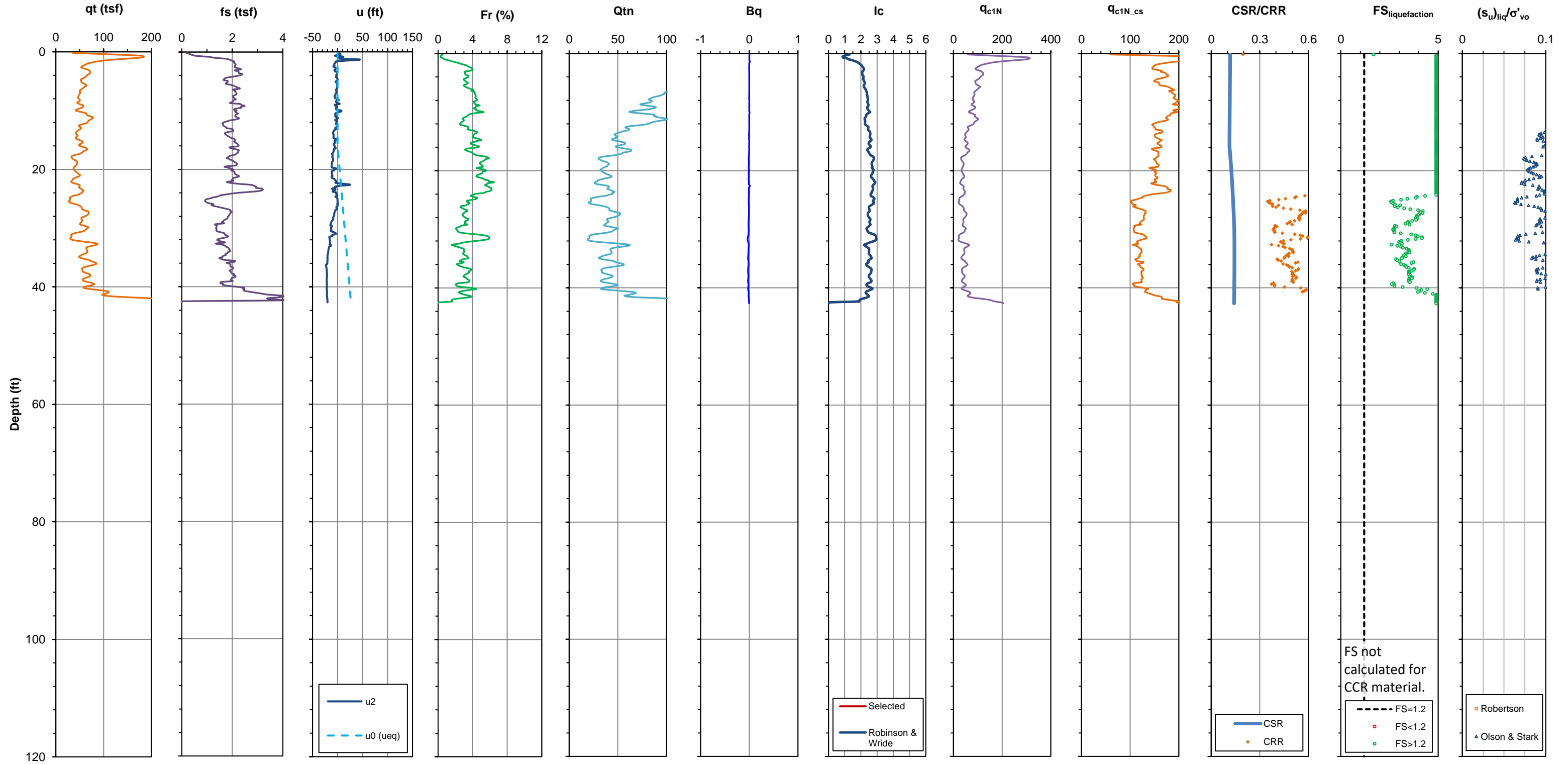
## 4.0 REFERENCES

- Atkinson, G.M. and D.M. Boore (2006) "Earthquake Ground-Motion Prediction Equations for Eastern North America," Bulletin of the Seismological Society of America, Vol. 96, No. 6, pp. 2181-2205.
- Robertson, P.K. and C.E. (Fear) Wride (1998) "Evaluating Cyclic Liquefaction Potential Using the Cone Penetration Test," Canadian Geotechnical Journal, Vol. 35, pp. 442-459.
- Youd, T.L. et al. (2001). "Liquefaction Resistance of Soils: Summary Report from the 1996 NCEER and 1998 NCEER/NSF workshops on Evaluation of Liquefaction Resistance of Soils", Journal of Geotechnical and Geoenvironmental Engineering, vol. 127, No. 4, April 2001.

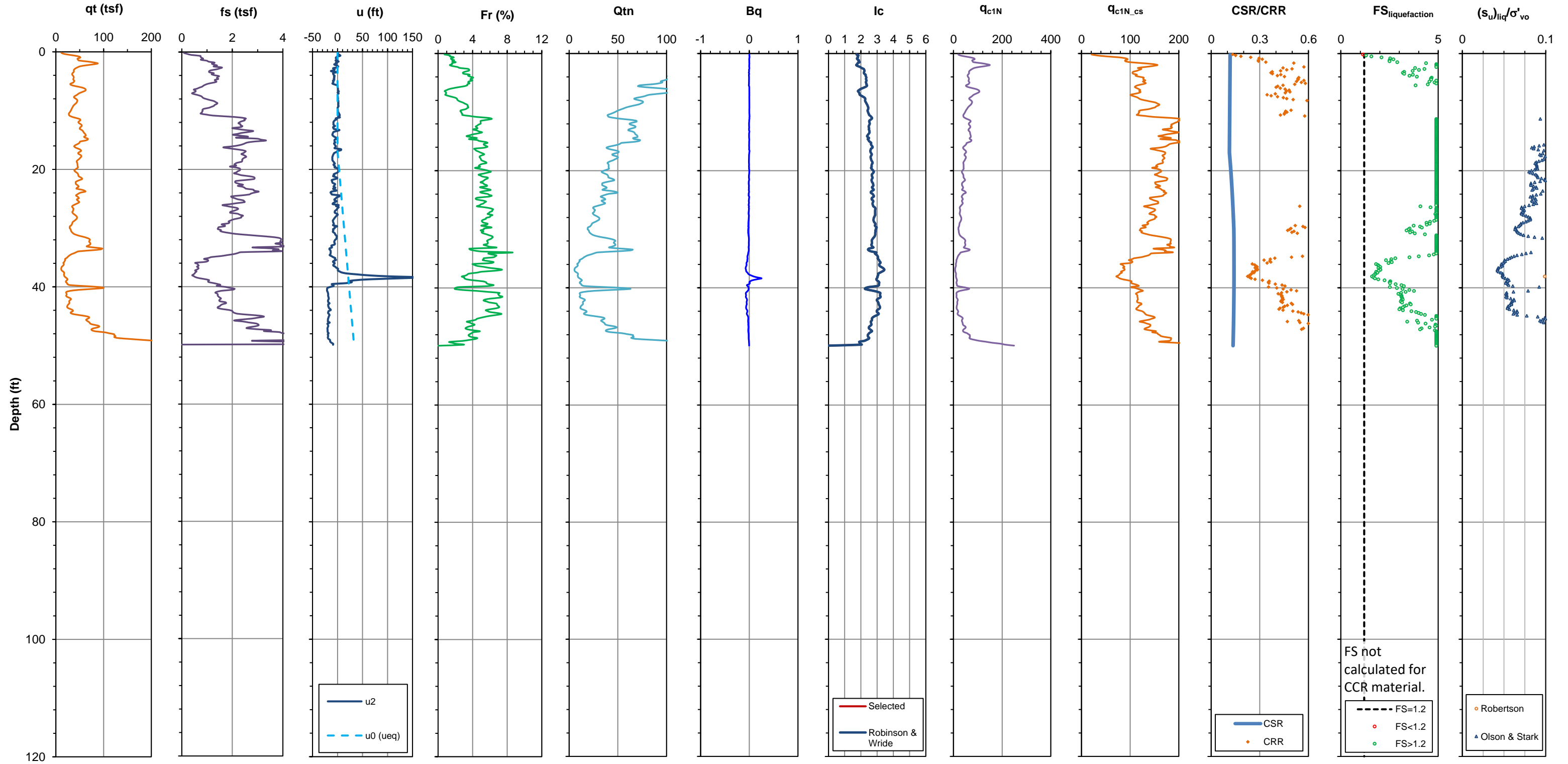
## 5.0 ATTACHMENTS

Liquefaction Factor of Safety Results

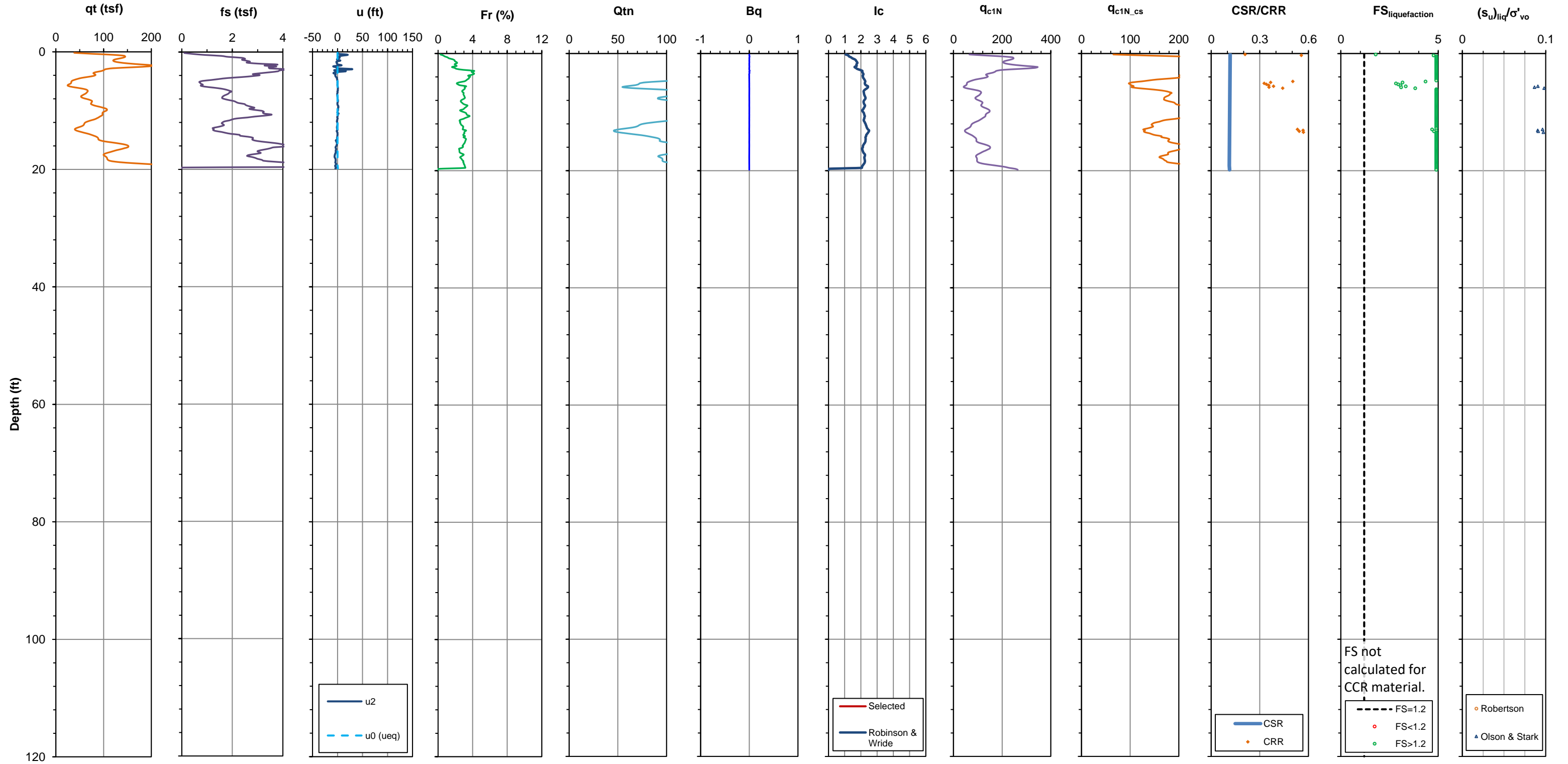
<b>Test Date:</b> 11/4/2015	<b>Project:</b> Plt McDonough Permitting	<b>Test Type:</b> CPTU	<b>Water Table:</b> 15.8 ft	<b>2% PE in 50 years Seismic Hazard</b>
<b>Test ID:</b> CPT-2-DAM	<b>Location:</b> Smyrna, GA	<b>Device:</b> 10 cm <sup>2</sup> , Type 2 filter	<b>Golder Eng:</b> L. Jin	<b>Magnitude:</b> 5.75
<b>Northing:</b> 1392584.5	<b>Client:</b> GPC	<b>Standard:</b> ASTM D5778	<b>Check:</b> G. Martin	<b>a<sub>max</sub>:</b> 0.18 g
<b>Easting:</b> 2202822.0	<b>Proj No.:</b> 1777449	<b>Push Co.:</b> ConeTec	<b>Review:</b> G. Hebel	
<b>Elevation:</b> 845.8 ft	<b>Termination:</b> 0.0 ft-bgs	<b>Operator:</b> ConeTec		



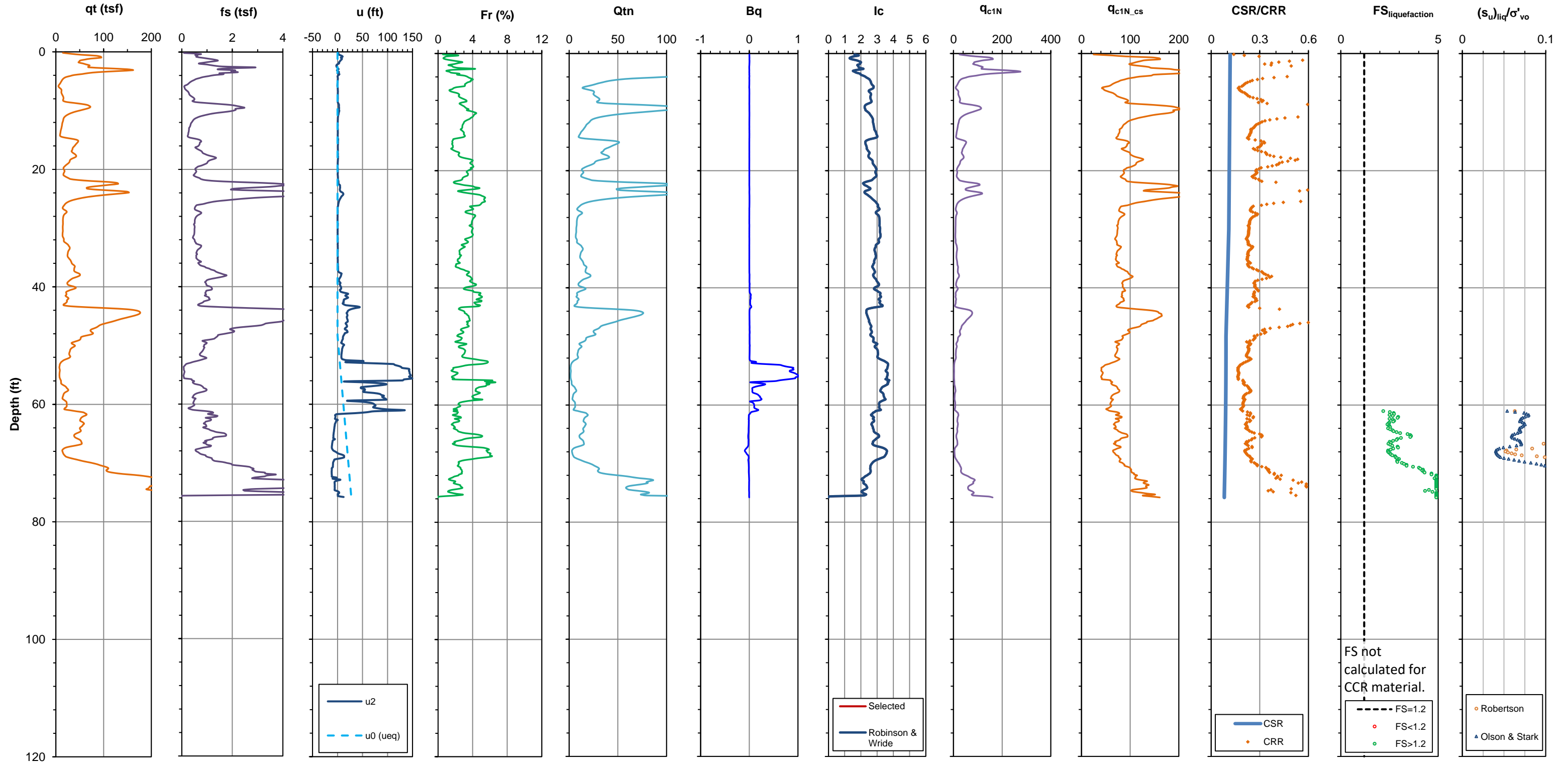
<b>Test Date:</b> 11/4/2015	<b>Project:</b> Plt McDonough Permitting	<b>Test Type:</b> CPTU	<b>Water Table:</b> 16.9 ft	<b>2% PE in 50 years Seismic Hazard</b>
<b>Test ID:</b> CPT-04-DAM	<b>Location:</b> Smyrna, GA	<b>Device:</b> 10 cm <sup>2</sup> , Type 2 filter	<b>Golder Eng:</b> L. Jin	<b>Magnitude:</b> 5.75
<b>Northing:</b> 1392271.1	<b>Client:</b> GPC	<b>Standard:</b> ASTM D5778	<b>Check:</b> G. Martin	<b>a<sub>max</sub>:</b> 0.18 g
<b>Easting:</b> 2201861.3	<b>Proj No.:</b> 1777449	<b>Push Co.:</b> ConeTec	<b>Review:</b> G. Hebler	
<b>Elevation:</b> 846.9 ft	<b>Termination:</b> 0.0 ft-bgs	<b>Operator:</b> ConeTec		



<b>Test Date:</b> 11/4/2015	<b>Project:</b> Plt McDonough Permitting	<b>Test Type:</b> CPTU	<b>Water Table:</b> 19.1 ft	<b>2% PE in 50 years Seismic Hazard</b>
<b>Test ID:</b> CPT-07-DAM	<b>Location:</b> Smyrna, GA	<b>Device:</b> 10 cm <sup>2</sup> , Type 2 filter	<b>Golder Eng:</b> L. Jin	<b>Magnitude:</b> 5.75
<b>Northing:</b> 1393082.5	<b>Client:</b> GPC	<b>Standard:</b> ASTM D5778	<b>Check:</b> G. Martin	<b>a<sub>max</sub>:</b> 0.18 g
<b>Easting:</b> 2201627.5	<b>Proj No.:</b> 1777449	<b>Push Co.:</b> ConeTec	<b>Review:</b> G. Hebel	
<b>Elevation:</b> 849.2 ft	<b>Termination:</b> 0.0 ft-bgs	<b>Operator:</b> ConeTec		

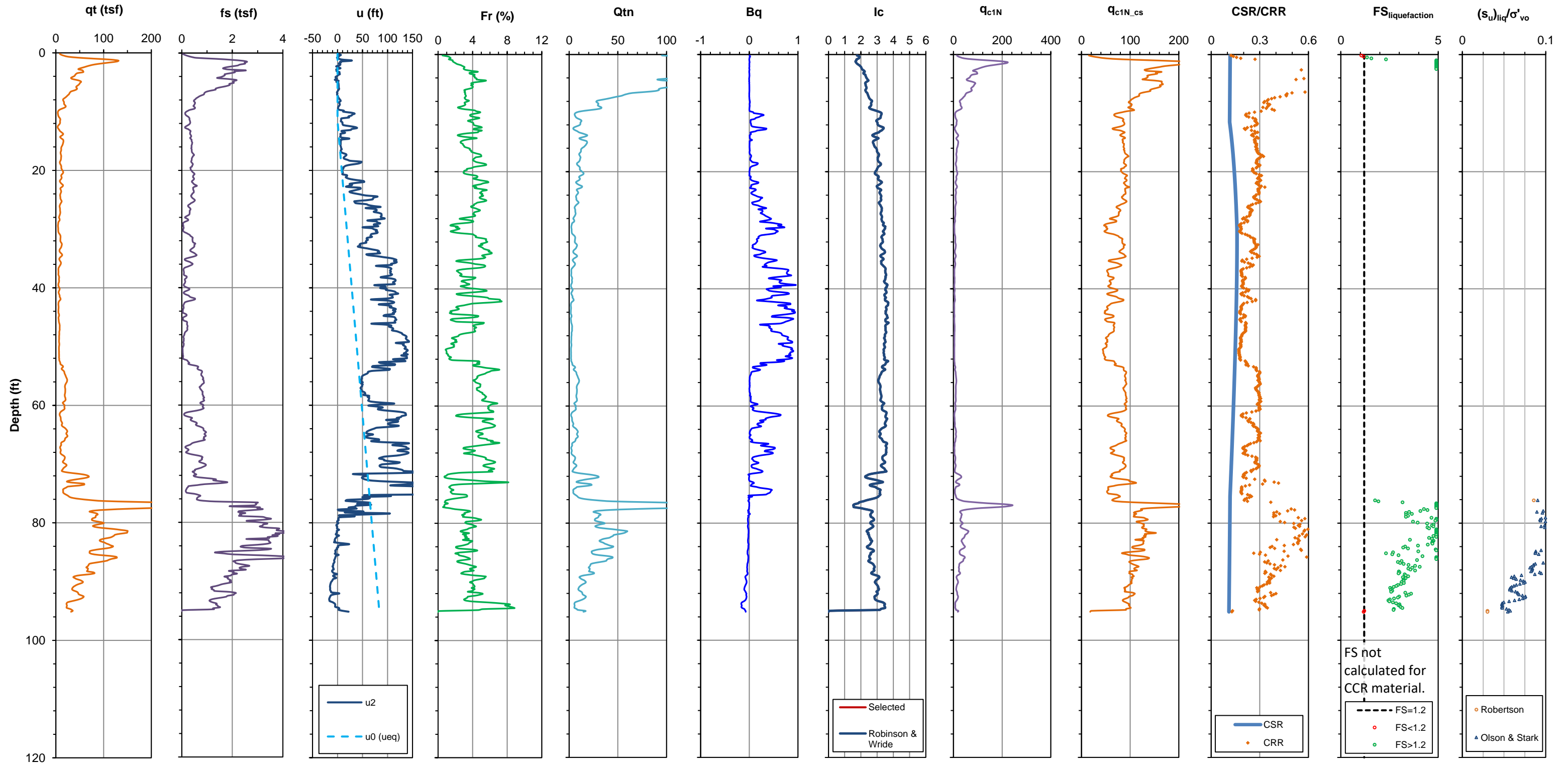


<b>Test Date:</b> 11/4/2015	<b>Project:</b> Plt McDonough Permitting	<b>Test Type:</b> CPTU	<b>Water Table:</b> 48.3 ft	<b>2% PE in 50 years Seismic Hazard</b>
<b>Test ID:</b> CPT-10-AP3	<b>Location:</b> Smyrna, GA	<b>Device:</b> 10 cm <sup>2</sup> , Type 2 filter	<b>Golder Eng:</b> L. Jin	<b>Magnitude:</b> 5.75
<b>Northing:</b> 132917.1	<b>Client:</b> GPC	<b>Standard:</b> ASTM D5778	<b>Check:</b> G. Martin	<b>a<sub>max</sub>:</b> 0.18 g
<b>Easting:</b> 2202107.3	<b>Proj No.:</b> 1777449	<b>Push Co.:</b> ConeTec	<b>Review:</b> G. Hebel	
<b>Elevation:</b> 878.3 ft	<b>Termination:</b> 0.0 ft-bgs	<b>Operator:</b> ConeTec		

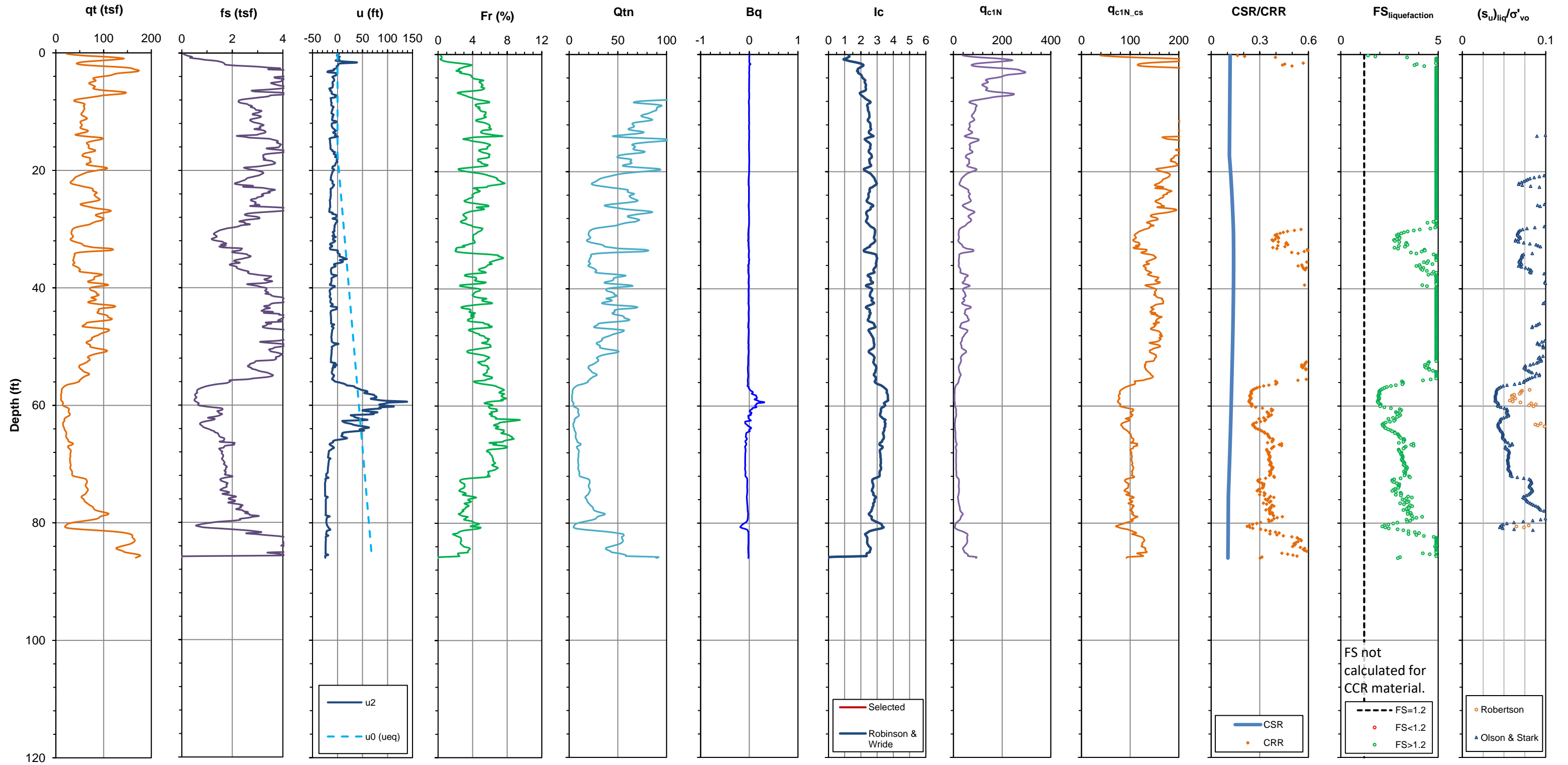




<b>Test Date:</b> 11/4/2015	<b>Project:</b> Plt McDonough Permitting	<b>Test Type:</b> CPTU	<b>Water Table:</b> 11.6 ft	<b>2% PE in 50 years Seismic Hazard</b>
<b>Test ID:</b> CPT-30-AP4	<b>Location:</b> Smyrna, GA	<b>Device:</b> 10 cm <sup>2</sup> , Type 2 filter	<b>Golder Eng:</b> L. Jin	<b>Magnitude:</b> 5.75
<b>Northing:</b> 1393796.0	<b>Client:</b> GPC	<b>Standard:</b> ASTM D5778	<b>Check:</b> G. Martin	<b>a<sub>max</sub>:</b> 0.18 g
<b>Easting:</b> 2203383.8	<b>Proj No.:</b> 1777449	<b>Push Co.:</b> ConeTec	<b>Review:</b> G. Hebel	
<b>Elevation:</b> 841.5 ft	<b>Termination:</b> 0.0 ft-bgs	<b>Operator:</b> ConeTec		



<b>Test Date:</b> 11/4/2015	<b>Project:</b> Plt McDonough Permitting	<b>Test Type:</b> CPTU	<b>Water Table:</b> 17.3 ft	<b>2% PE in 50 years Seismic Hazard</b>
<b>Test ID:</b> CPT-44-AP4	<b>Location:</b> Smyrna, GA	<b>Device:</b> 10 cm <sup>2</sup> , Type 2 filter	<b>Golder Eng:</b> L. Jin	<b>Magnitude:</b> 5.75
<b>Northing:</b> 1394120.5	<b>Client:</b> GPC	<b>Standard:</b> ASTM D5778	<b>Check:</b> G. Martin	<b>a<sub>max</sub>:</b> 0.18 g
<b>Easting:</b> 2203001.0	<b>Proj No.:</b> 1777449	<b>Push Co.:</b> ConeTec	<b>Review:</b> G. Hebler	
<b>Elevation:</b> 847.3 ft	<b>Termination:</b> 0.0 ft-bgs	<b>Operator:</b> ConeTec		



**APPENDIX E**

**Settlement Analysis Calculation  
Package**

## CALCULATIONS

**Date:** June 2018

**Made by:** LJ

**Project No.:** 1777449

**Checked by:** JGM

**Subject:** Settlement Analyses

**Reviewed by:** GLH

### **PROJECT: PLANT MCDONOUGH-ATKINSON INACTIVE CCR SURFACE IMPOUNDMENTS AP-2 AND COMBINED UNIT AP-3/4 CLOSURE**

#### **1.0 OBJECTIVE**

This calculation package summarizes the settlement analyses performed for the closed conditions of the inactive coal combustion residuals (CCR) surface impoundments AP-2 and Combined Unit AP-3/4 at Plant McDonough-Atkinson (Plant McDonough), located at 84.476°W and 33.829°N. Settlement analyses were completed to check closure cap design grades for grade reversal caused by settlement of ash.

#### **2.0 SETTLEMENT ANALYSIS METHODOLOGY**

The majority of CCR settlement is expected to occur during closure as ash is placed, graded, and dewatered prior to capping. Settlement caused by ash grading activities will largely occur before the final cap is constructed and as such was excluded from post-closure settlement calculations. The closure design of AP-3/4 also includes significant active dewatering during closure which is expected to result in most dewatering induced settlements to be complete prior to final grading and capping.

Post-closure settlement of Combined Unit AP-3/4 is expected to occur based on any remaining water level lowering within the capped CCR material after closure. Since the compressibility of the compacted ash layers are negligible, only settlement in sluiced ash was calculated during consolidation process.

Settlement analyses were completed by calculating settlement at discrete locations within the pond spaced on a 10-ft grid and at every one foot along drainage channels. Settlement analysis results were used to create isopach maps of the total settlement and contours of closure cap grades after settlement. To account for variation and uncertainties relating to ash cementation, a conservative approach was conducted by assuming the over consolidation ratio (OCR) of sluiced ash equals 1.0. Based on Golder's experience, sluiced ash typically has an OCR value of around 2.5.

#### **2.1 Settlement Analysis**

Traditional consolidation theory with material properties based on Golder's experience at other ash storage facilities was applied to obtain a conservative settlement prediction at each discrete settlement location within the pond. The

following equations were used to calculate primary settlement in 1-ft layers, then summed up for total primary settlement (Das 2007).

$$S_p = H * C'_c * \log\left(\frac{\sigma_f}{\sigma_i}\right) \text{ for } \sigma_f < \sigma_p$$

$$S_p = H * \left( C'_c * \log\left(\frac{\sigma_p}{\sigma_i}\right) + C'_r * \log\left(\frac{\sigma_f}{\sigma_p}\right) \right) \text{ for } \sigma_i < \sigma_p < \sigma_f$$

$$S_p = H * C'_r * \log\left(\frac{\sigma_f}{\sigma_i}\right) \text{ for } \sigma_p < \sigma_i$$

Where:

- S<sub>p</sub> = Primary settlement
- H = Thickness of layer
- C'<sub>c</sub> = Coefficient of consolidation (strain)
- C'<sub>r</sub> = Coefficient of recompression (strain)
- σ<sub>i</sub> = initial effective stress
- σ<sub>f</sub> = final effective stress
- σ<sub>p</sub> = pre consolidation pressure

## 2.2 Material Properties

The material properties used for settlement analyses are presented in Table 1. It should be noted that settlement in stacked ash, compacted ash, and backfill soil is negligible.

**Table 1: Designed Layers for Settlement Analysis**

Summary of Material Consolidation Properties				
Name	Unit Weight (pcf)	OCR	C' <sub>c</sub> (strain)	C' <sub>r</sub> (strain)
Sluiced ash	90	1.0	0.18	0.024
Stacked ash	110	N/A	N/A	N/A
Compacted ash	110	N/A	N/A	N/A
Backfill soil	125	N/A	N/A	N/A

## 3.0 RESULTS AND CONCLUSION

As discussed above, most of the settlement due to grading and dewatering of ash is calculated to occur prior to final grading and capping. The post closure settlement analysis results for the AP-3/4 unit are presented in Figure 1 below. The maximum calculated settlement in ash pond is less than 0.1 feet (< 1 inch). Therefore, settlement is

expected to have minimal impact to the final grades after closure. Should localized areas of settlement occur, these will be monitored and can be maintained as necessary through the post-closure care inspection program.

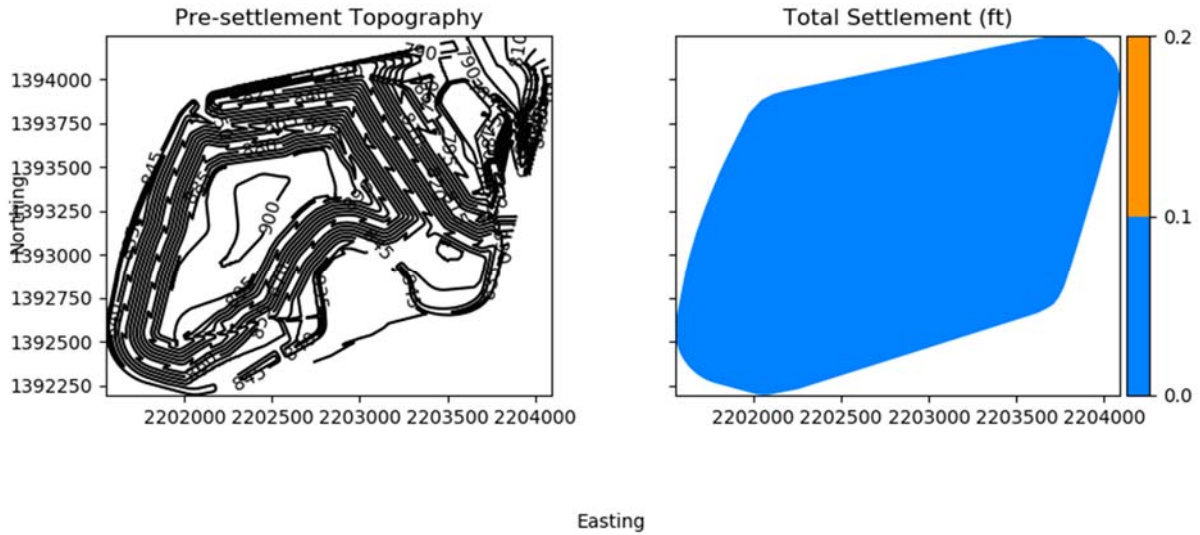


Figure 1. Settlement analysis for AP3/4.

#### 4.0 REFERENCES

Das, Braja M. (2006), Principles of Geotechnical Engineering. Sixth Edition.

**APPENDIX F**

**Under Slope Drainage System**

### 1.0 OBJECTIVE

To evaluate the minimum capacity of the under slope drainage system of the final closure of AP-3/4 at Plant McDonough-Atkinson (Plant McDonough) located in Cobb County, GA. This includes the capacity evaluation of the geocomposite drain, sand trench drains, and drainage pipes. Component details for the under slope drainage system can be found on Sheet 8 of the Plant McDonough-Atkinson AP-2 and AP-3/4 Closure Drawings.

### 2.0 BACKGROUND

An under slope drainage system has been proposed for the collection and conveyance of contact water that collects along the eastern face and toe of the eastern slope of the proposed closed design for combined unit AP-3/4. The under slope drainage system (Figure 1 and also located on Closure Plan Sheet 8) has been proposed to:

- Collect potential seepage from the existing ash; and
- Serve as a drainage layer for water that has contacted the ash and relocated ash during the pond closure.

There are four main components of the under slope drainage system:

- Geocomposite strips
- 3 ft. by 3 ft. sand and gravel trench drains
- Perforated HDPE contact water collection pipes
- Under Slope Collection Sump

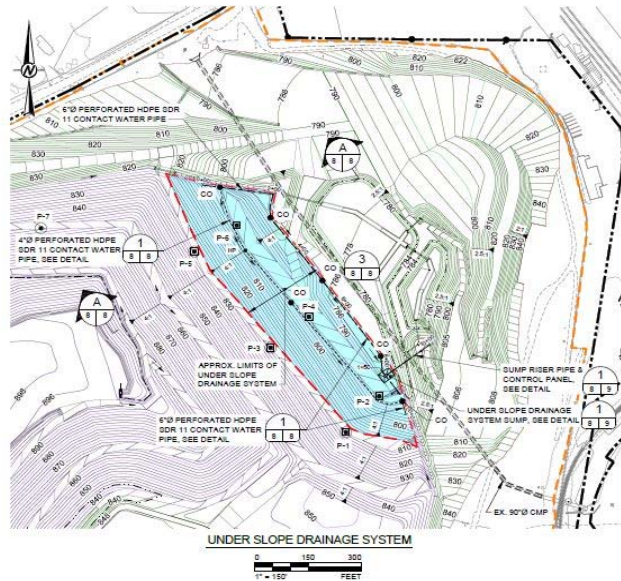


Figure 1 - Under Slope Drainage System (within blue shaded area)

### 3.0 GEOCOMPOSITE CAPACITY

Geocomposite strips are designed as a back up protective component of the under slope drainage system in order to convey contact water within the eastern limits of AP-3/4 that potentially migrates to the face of the ash cut slope to the under slope drainage system sump. The capacity of the geocomposite strips proposed for the under slope drainage system is based on current state of the practice and reduction factors to evaluate the proposed system. Based on the specified transmissivity of the geocomposite identified for use for the closure of Plant McDonough Closure of Ash Pond 1, 3 and 4 Technical Specifications of  $9.0 \times 10^{-4}$  meters squared per second ( $m^2/sec$ ), the design transmissivity of the geocomposite strips layer under the soil buttress as part of the under slope drainage system is calculated based on the recommendations provided in GRI GC8 "Determination of the Allowable Flow Rate of a Drainage Geocomposite".





**SUBJECT: Under Slope Drainage System Capacity**  
**Project Number: 1777449**  
**Project Name: Plant McDonough Surface Impoundment Units**  
**AP-3/4 Closure**

**Prepared by: LS**

**Checked by: GLH**

**Date: Jul 2018**

**Reviewed by: GLH**

### 3.1 Calculations

$$T_{allow} = T_{ult} \times \frac{1}{RF_{IN} \times RF_{CR} \times RF_{CC} \times RF_{BC}}$$

where:

- T<sub>allow</sub> = minimum allowable flow rate or transmissivity
- T<sub>ult</sub> = ultimate (design or as-manufactured) flow rate or transmissivity
- RF<sub>IN</sub> = 1.3 product
- RF<sub>CR</sub> = 1.2 Reduction Factor for Creep (based on loading)
- RF<sub>CC</sub> = 1.2 Reduction Factor for Chemical Clogging
- RF<sub>BC</sub> = 1.0 Reduction Factor for Biological Clogging

T<sub>ult</sub> = 9.0E-04 m<sup>2</sup>/sec therefore T<sub>allow</sub> = 4.8E-04 m<sup>2</sup>/sec

The equivalent hydraulic conductivity is k = T / thickness  
 thickness of geocomposite = 300 mil

Therefore: **k<sub>allow</sub> = equivalent hydraulic conductivity = 6.31 cm/sec**

### 3.2 Design

Geocomposite will be laid in four separate sections along the eastern slope of the unit as part of the under slope drainage system: Two sections are located along the first tier of the eastern slope, and two sections are located along the second tier of the eastern slope (Figure 2). These geocomposite sections will be approximately 60 feet apart (15 feet of vertical separation). The geocomposite strip sections will be approximately 15 feet wide. Geocomposite quantities in the underdrain system are as follows:

**Table 1: Geocomposite in Under Slope Drainage System Quantities**

Geocomposite Section	Length (ft)	Surface Area (ft <sup>2</sup> )	Strip Location
Section A	645	9,675	Lower Strip - Lower Bench
Section B	730	10,950	Middle Strip - Lower Bench
Section C	780	11,700	Lower Strip - 2nd Bench
Section D	845	12,675	Middle Strip - 2nd Bench

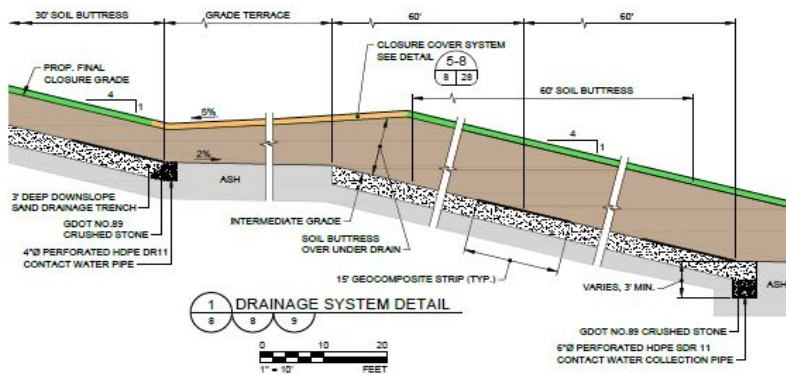


Figure 2 - Under Slope Drainage System Section & Detail

### 4.0 SAND TRENCH DRAINS

The under slope drainage system includes the use of downslope sand drainage trenches for collection and conveyance of contact water. These trench drains have a proposed width of 3 ft and depth of 3 ft, with a typical horizontal spacing of 25 ft between each sand trench along the slope (Detail B of Closure Plan Drawings Sheet 8). The hydraulic conductivity has been estimated for the #10 sand (GDOT) based on GDOT specifications.

Material	k (cm/sec)	k (ft/sec)
GDOT #10 Sand	0.03	9.84E-04



**SUBJECT: Under Slope Drainage System Capacity**  
**Project Number: 1777449**  
**Project Name: Plant McDonough Surface Impoundment Units**  
**AP-3/4 Closure**  
**Prepared by: LS** **Checked by: GLH**  
**Date: Jul 2018** **Reviewed by: GLH**

#### 4.1 Calculations

The design capacity for the trench drains will be evaluated based on Darcy's Law. Darcy's Law states that the hydraulic conductivity (k) is related to the flow rate (q), cross-sectional area of the drain (A), length of flow (l) and the change in total head (DH) by the following relationship:

$$\rightarrow q = \frac{k \times \Delta H \times A}{l} \quad k = \frac{ql}{A\Delta H}$$

There are two groupings of the sand drainage trenches proposed in the design. Trenches terminating at the 6-inch dia. perforated HDPE contact water collection pipe, and trenches terminating at the 4-inch dia. perforated HDPE contact water collection pipe. The estimated cumulative lengths for sand drainage trenches are summarized in Table 2 below:

**Table 2: Sand Trench Drain Capacities in Under Slope Drainage System**

Trench Drains	Cumulative Length (ft)
Terminating at 6" dia. contact water pipe	1,084
Terminating at 4" dia. contact water pipe	3,704
<b>Total Trench Drains</b>	<b>4,788</b>

#### 5.0 CONTACT WATER DRAINAGE PIPES

The under slope drainage system includes perforated HDPE SDR 11 contact water collection pipes (Figure 1 and Closure Permit Plan Sheet 8) to convey contact water collected by the geocomposite drains and sand drainage trenches to the under slope collection sump. As shown on the Closure Permit Plan, the 4-inch dia. perforated HDPE contact water collection pipe at the 40 ft. terrace conveys contact water from geocomposite and sand trench drain drainage components, and the northern half of the pipe conveys water to the 6-inch dia. contact water pipe. The 6-inch dia. perforated HDPE contact water collection pipe at the toe of the eastern slope conveys water from the geocomposite and sand trench drain drainage components, and the 4-inch dia. contact water pipe. The drainage pipes will capture flow from the geocomposite and sand drains via the perforations, and discharge the flow at the under slope sump.

#### 5.1 Calculations for Contact Water Drainage Pipe Capacity

Manning's Equation was utilized for the calculation of velocity, and in turn the capacity in the pipe for the given parameters, as it is assumed that open channel flow exists in a pipe when flowing partially full.

$$v = \frac{1.49}{n} r^{2/3} s^{1/2}$$

- where: r = hydraulic radius (or D/4) (ft)
  - s = slope of drainage pipe (ft/ft)
  - n = Manning's roughness coefficient, 0.008 - 0.011 for HDPE pipes
- For these calculations, an n-value of 0.009 was assumed.

Table 3 below summarizes the capacities of the drainage pipes specified in the under slope drainage system. Table 4 evaluates the capacity of these pipes during the 25-year, 24-hour and 100-year, 24 hour storm events considered for the design.

**Table 3: HDPE Drainage Pipe Capacities in Under Slope Drainage System**

Drainage Pipe	Pipe Diameter (ft)	n	A (ft²)	S (ft/ft)	V (ft/s)	Capacity (Q, cfs)	Capacity (GPM)	Storage in Pipe (ft³)
6-inch dia. contact water pipe	0.5	0.009	0.20	0.009	3.9	0.77	346.0	153.2
4-inch dia. contact water pipe (draining north)	0.33	0.009	0.09	0.02	4.5	0.39	175.0	74.2
4-inch dia. contact water pipe (draining south)	0.33	0.009	0.09	0.03	5.5	0.48	214.3	
<b>Drainage Pipe Capacity to Drainage Sump</b>						<b>1.25</b>	<b>560.3</b>	<b>227.3</b>



**SUBJECT: Under Slope Drainage System Capacity**  
**Project Number: 1777449**  
**Project Name: Plant McDonough Surface Impoundment Units**  
**AP-3/4 Closure**  
**Prepared by: LS** **Checked by: GLH**  
**Date: Jul 2018** **Reviewed by: GLH**

**Table 4: Capacity of Drainage Pipes for 24 Hours**

Drainage Pipe	Duration (hr)	Capacity (ft <sup>3</sup> )	Capacity (gal)
4-inch dia. contact water pipe (draining north)	24	33,680	251,923
4-inch dia. contact water pipe (draining south)	24	41,249	308,541
6-inch dia. contact water pipe	24	66,611	498,253

## 6.0 DRAINAGE SUMP CAPACITY

The proposed contact water drainage sump (Closure Permit Plan Sheet 9) is the collection point where contact water from the drainage appurtenances summarized in Table 4 is routed to and collected via the contact water riser pipe and submersible pump. Contact water sump parameters are summarized below.

**Table 5: Summary of Drainage Sump Parameters**

	Length (ft)	Width at Base (ft)	Width at Top (ft)	Capacity of Sump (ft <sup>3</sup> )	Standing Volume (ft <sup>3</sup> )	Pumpable Volume (ft <sup>3</sup> )
Contact Water Sump	29	10	34	2,552	638	1,914

The contact water sump has been outfitted with an underdrain sump pump, capable of managing 30 gallons per minute (GPM) and able to pump a dynamic head of 90 vertical feet. Contact water sump and pump performance parameters are summarized below. The long term steady state groundwater conditions at the site were estimated using MODFLOW and estimated the long term steady state flow into the underdrain system as 7 GPM in the long term after steady state is reached.

**Table 6: Summary of Drainage Sump Pump and Contact Sump Performance Parameters**

Pump Location	Pipe Diameter	Pump Flow (GPM)	Head (ft)	Modelled Flow from Under Slope Drainage System in Long Term (GPM)	Capacity in Sump (Pumping) (Gal)	Capacity in Sump if Not Pumping (minutes)
Drainage Sump Pump	2 in.	30	90	7	14,317	2,045

## 7.0 SUMMARY AND CONCLUSION

The proposed under slope drainage system is designed to control contact water seepage from the eastern slope of the closure conditions of Plant McDonough Combined Unit AP-3/4. The maximum seepage rate able to be managed by the under slope contact water drainage pipes designed is approximately 560 GPM. The modelled groundwater collection within the under drain slope in the long term is approximately 7 GPM, with the underdrain system effectively lowering ground water levels below the bottom of ash. If the pump system were to fail or require maintenance, the under drain sump has storage capacity equal to nominally 2045 minutes within the sump itself, and an additional 100 days of capacity within the slope piping system. In addition to the contact water drainage sump and drainage pipe system, the sand trenches and geocomposite drainage layers provide additional contact water storage capacity within the under slope drainage system if needed.

## 9.0 REFERENCES

- Koerner, R. M. Designing with Geosynthetics. 3rd ed. Englewood Cliffs, N.J.: Prentice Hall, 1994.
- Koerner, R.M., Koerner, G.R. Reduction Factors Used in Geosynthetic Design, GSI White Paper #4. Rev. 2007. Geosynthetic Research Institute.
- Technical Specifications, Earthwork and Final Cover Installation for Closure of Ash Pond 1, 3 and 4, Plant McDonough. Georgia Power Company, 2015.

**APPENDIX G**

**Alternative Final Cover Evaluation**

## CALCULATIONS

**Date:** November 2018  
**Project No.:** 1777449  
**Subject:** Final Cover Equivalency

**Made by:** LS  
**Checked by:** GLH  
**Reviewed by:** GLH

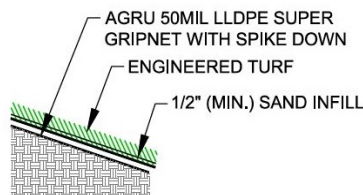
**PROJECT: GEORGIA POWER COMPANY– PLANT MCDONOUGH-ATKINSON CCR UNIT AP-1 AND COMBINED CCR UNIT AP-3/4 CLOSURE**

### 1.0 INTRODUCTION AND PURPOSE OF ANALYSIS

Golder Associates Inc. (Golder) and Southern Company Services (SCS) have designed the final closure systems for CCR Unit AP-1 and Combined CCR Unit AP-3/4 at Plant McDonough-Atkinson (Plant McDonough), located in Smyrna, GA. As part of the closure design, Golder conducted an evaluation of the percolation potential and liner performance for the final cover systems for AP-1 and AP-3/4. These analyses, with the use of the US EPA Hydrologic Evaluation of Landfill Performance (HELP) model version 3.07, provide estimates and ranges of the anticipated drainage collected from the final cover system as well as percolation rates through the cover systems on a per plan acre basis. Performance for the designed final cover systems, consisting of ClosureTurf™ is presented to demonstrate equivalent or superior performance to a CCR Unit cover system, as per regulatory requirements (Georgia Solid Waste Management Regulations, Section. 391-3-4-.10(7) and 40 CFR 257.102(d)).

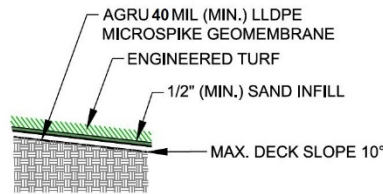
### 2.0 ANALYSIS PARAMETERS AND CONDITIONS

Analysis for the closure systems was based on the ClosureTurf™ final cover system presented in Figures 1 and 2 below. The final closure conditions for CCR Units 1 and 3/4 at Plant McDonough both consist of sluiced CCR material overlain by stacked CCR material to a maximum combined thickness of 80 feet (representative of the maximum design final height of CCR at AP-3/4), overlain by a geomembrane, engineered turf layer, and sand infill. ClosureTurf™ with Super Gripnet® geomembrane was utilized as the main cover system at AP-1 and AP-3/4 with maximum designed side slopes of 4 ft. horizontal to 1 ft. vertical over CCR areas. MicroSpike® geomembrane of minimum thickness of 40 mils was utilized in place of the 50 mil Super Gripnet® in some areas with shallower slopes, up to a maximum deck slope of 10 degrees. The top deck evaluations of percolation all use the thinner 40 mil MicroSpike® option for conservatism in the evaluations. Areas utilizing Super Gripnet® geomembrane and MicroSpike® geomembrane as part of the cover system are identified in the Closure Design Plan Drawings.



**CLOSURETURF FINAL COVER WITH SUPER GRIPNET DETAIL**

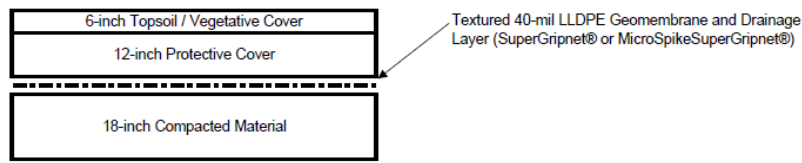
*Figure 1*



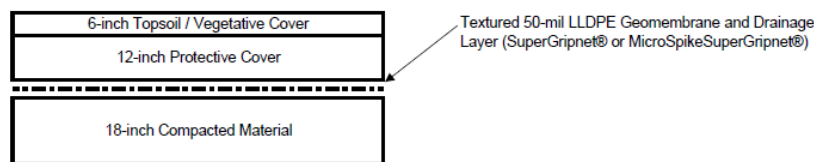
**CLOSURETURF FINAL COVER WITH MICROSPIKE DETAIL**

*Figure 2*

Additionally, Golder analyzed a cover system consisting of a 6-inch vegetative soil layer, 12-inch protective cover layer, double sided geocomposite drainage layer, textured 40-mil minimum thickness LLDPE geomembrane and drainage layer, underlain by an 18-inch compacted material layer as a final cover option as shown in Figures 3 and 4. This cover system option is included for the potential use of a vegetative cover in place of the ClosureTurf™ engineered system in future repairs.

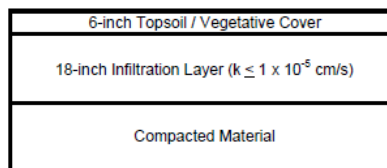


*Figure 3 – Soil & Liner Closure System at Top Deck*



*Figure 4 – Soil & Liner Closure System at Side Slopes*

Finally, Golder analyzed the prescribed CCR unit final cover as presented in §257.102(d)(3)(i) consisting of a 6-inch vegetative soil layer underlain by an 18-inch soil infiltration layer with a minimum hydraulic conductivity of  $1 \times 10^{-5}$  centimeters per second (cm/s) as a base case scenario in the HELP model, as shown in Figure 5.



*Figure 5 – CCR Unit Final Cover*

## 2.1 Weather Data

Assumptions were made within the HELP model pertaining to weather data for the site location. Precipitation data for Atlanta, Georgia was used for monthly mean precipitation. This data took into account the 25-year, 24 hour storm for Atlanta, GA (GSMM 2001). Synthetic mean temperature data based on 5 years, solar radiation for 33.65° station latitude, and evapotranspiration data for Atlanta, GA from the HELP model database were utilized. Evaporative zone depth values representing fair vegetation quality were utilized for final conditions, and a maximum leaf area index of fair stand (2.0) for final conditions was modeled. The possibility of runoff was estimated for the site as 100% for final conditions. The evapotranspiration data parameters are summarized in Table 1 below.

**Table 1: Evapotranspiration Parameters - HELP Model**

Stage	% of Area Allowing Runoff	Equivalent Evaporative Zone Depth (in.)	Equivalent Maximum Leaf Area Index	Equivalent Quality of Vegetation
Final Closure Conditions - ClosureTurf™ Option	100	0.7 <sup>(1)</sup>	2 <sup>(1)</sup>	Fair <sup>(2)</sup>
Final Closure Conditions – Soil/Liner Option	100	10	2	Fair
Final Closure Conditions – CCR Unit Cover	100	10	2	Fair
<p>(1) – Equivalent properties recommended by the manufacturer of ClosureTurf™ as based on test data</p> <p>(2) Assumed equal to natural grass case</p>				

## 2.2 Soil and Design Data

The layers summarized in Table 1 must each be designated as one of the four types of layers modeled by HELP, described below. Table 3 outlines the layer designation type for each layer of the three development conditions modeled.

Type 1 – vertical percolation

Type 2 – lateral drainage

Type 3 – barrier soil liner

Type 4 – geomembrane liner

Assumed geomembrane cover conditions of one (1) pinhole per acre, (1) installation defects per acre, and good placement quality were used for all applicable analyses. A runoff drainage length of 400 feet and a slope of 25% representative of the northern slope of AP-3/4 were used in model calculation for final conditions Layer 3 (total drainage lengths ranged from 310 at the southern slope to 400 ft at the northern slope). This length represents the longest slopes at the facility, and the model results are applied to the remaining AP-3/4 and AP-1 slopes for

conservatism. It is important to note that drainage benches are located at approximately 30 vertical feet down the slope, but the model accounts for a total drainage length at a constant slope for conservatism. The SCS Run-off curve number is 98, as recommended by ClosureTurf™ manufacturers for estimates in engineering calculations representative of high runoff.

**Table 2: Layers Designation in HELP Model for Development Conditions**

Development Stage	Layer 1	Layer 2	Layer 3	Layer 4	Layer 5	Layer 6
Final Closure Conditions - ClosureTurf™	1 (ClosureTurf™ grass stand)	2 (ClosureTurf™ Geotextile backing)	4 (Geomembrane Liner)	3 (compacted CCR material)	1 (CCR material)	--
Final Closure Conditions – Soil/Liner Option	1 (6-in. vegetative layer)	1 (12-in. Protective Cover)	2 (Double Sided Geocomposite)	4 (LLDPE Geomembrane Liner)	3 (compacted CCR material)	1 (CCR material)
Final Closure Conditions – CCR Unit Cover	1 (6-in. vegetative layer)	3 (18-in. $1 \times 10^{-5}$ cm/s infiltration layer)	1 (CCR material)	--	--	--

### 3.0 HELP MODEL RESULTS

A simulation period of 30 years was modeled for the final conditions at Plant McDonough. Results for the base case scenario (prescribed CCR Unit cover system) using the parameters outlined in Section 2 are presented in Tables 3 and 4 below. The average calculated percolation through the CCR Unit final cover at AP-3/4 was calculated to be approximately 184 cubic feet per acre per day, whereas the average calculated percolation through the ClosureTurf™ final cover at AP-3/4 was calculated to range from 0.002 to 0.008 cubic feet per acre per day.

**Table 3: Calculated Model Results - Percolation and Depth of Water on Final Cover System Side Slopes**

Development Stage	Average Daily Percolation (ft <sup>3</sup> /day/acre)	Average Annual Percolation (ft <sup>3</sup> /year/acre)	Maximum Percolation (ft <sup>3</sup> /day/acre)
Final Closure Conditions - ClosureTurf™	0.002	0.606	0.017
Final Closure Conditions – Soil/Liner Option	0.468	170.9	35.7



Development Stage	Average Daily Percolation (ft <sup>3</sup> /day/acre)	Average Annual Percolation (ft <sup>3</sup> /year/acre)	Maximum Percolation (ft <sup>3</sup> /day/acre)
Final Closure Conditions – CCR Unit Cover	183.8	67,100	1,646.3

**Table 4: Calculated Model Results - Percolation and Depth of Water on Final Cover System Top Deck (3%)**

Development Stage	Average Daily Percolation (ft <sup>3</sup> /day/acre)	Average Annual Percolation (ft <sup>3</sup> /year/acre)	Maximum Percolation (ft <sup>3</sup> /day/acre)
Final Closure Conditions - ClosureTurf™	0.008	2.74	0.069
Final Closure Conditions – Soil/Liner Option	4.22	1,541.4	37.4
Final Closure Conditions – CCR Unit Cover	183.8	67,100	1,646.3

The evaluation of the ClosureTurf™ final cover system, a traditional soil/liner cover system, and the prescribed Soil CCR Unit Cover system indicates that the ClosureTurf™ cover is calculated to have significant performance improvements as compared to the other systems. The ClosureTurf™ cover system results in significant calculated percolation improvements for both the side slope and top deck conditions as compared to a Soil/Liner and Soil CCR Unit Cover system.

#### 4.0 ATTACHMENTS

1. HELP Model Version 3.07 Outputs - Plant McDonough ClosureTurf™ Sideslope
2. HELP Model Version 3.07 Outputs - Plant McDonough Soil and Liner Cover Sideslope
3. HELP Model Version 3.07 Outputs - Plant McDonough CCR Unit Cover Sideslope
4. HELP Model Version 3.07 Outputs - Plant McDonough ClosureTurf™ Top Deck
5. HELP Model Version 3.07 Outputs - Plant McDonough Soil and Liner Cover Top Deck
6. HELP Model Version 3.07 Outputs - Plant McDonough CCR Unit Cover Top Deck

#### 5.0 REFERENCES

US EPA (1994). Hydrologic Evaluation of Landfill Performance (HELP) Model Version 3.07. *United States Environmental Protection Agency*.

US EPA (1994). Hydrologic Evaluation of Landfill Performance (HELP) Model Version, User's Guide for Version 3. Publication No. EPA/600/R-94/168A, 1994

Watershed Geo (2017). ClosureTurf™ with 50mil Super Gripnet® Product Data Sheet.

Watershed Geo (2017). ClosureTurf™ with 40mil Micro spike® Product Data Sheet.



MCDSGS18.txt

TYPE 2 - LATERAL DRAINAGE LAYER

MATERIAL TEXTURE NUMBER 34

THICKNESS	=	0.24	INCHES
POROSITY	=	0.8500	VOL/VOL
FIELD CAPACITY	=	0.0100	VOL/VOL
WILTING POINT	=	0.0050	VOL/VOL
INITIAL SOIL WATER CONTENT	=	0.0071	VOL/VOL
EFFECTIVE SAT. HYD. COND.	=	33.0000000000	CM/SEC
SLOPE	=	25.00	PERCENT
DRAINAGE LENGTH	=	400.0	FEET

LAYER 3

-----

TYPE 4 - FLEXIBLE MEMBRANE LINER

MATERIAL TEXTURE NUMBER 36

THICKNESS	=	0.05	INCHES
POROSITY	=	0.0000	VOL/VOL
FIELD CAPACITY	=	0.0000	VOL/VOL
WILTING POINT	=	0.0000	VOL/VOL
INITIAL SOIL WATER CONTENT	=	0.0000	VOL/VOL
EFFECTIVE SAT. HYD. COND.	=	0.399999993000E-12	CM/SEC
FML PINHOLE DENSITY	=	1.00	HOLES/ACRE
FML INSTALLATION DEFECTS	=	1.00	HOLES/ACRE
FML PLACEMENT QUALITY	=	3 - GOOD	

LAYER 4

-----

TYPE 3 - BARRIER SOIL LINER

MATERIAL TEXTURE NUMBER 6

THICKNESS	=	12.00	INCHES
POROSITY	=	0.4530	VOL/VOL
FIELD CAPACITY	=	0.1900	VOL/VOL
WILTING POINT	=	0.0850	VOL/VOL
INITIAL SOIL WATER CONTENT	=	0.4530	VOL/VOL
EFFECTIVE SAT. HYD. COND.	=	0.720000011000E-03	CM/SEC

LAYER 5

-----

TYPE 1 - VERTICAL PERCOLATION LAYER

MATERIAL TEXTURE NUMBER 6

THICKNESS	=	948.00	INCHES
POROSITY	=	0.4530	VOL/VOL
FIELD CAPACITY	=	0.1900	VOL/VOL
WILTING POINT	=	0.0850	VOL/VOL
INITIAL SOIL WATER CONTENT	=	0.1900	VOL/VOL
EFFECTIVE SAT. HYD. COND.	=	0.720000011000E-03	CM/SEC

GENERAL DESIGN AND EVAPORATIVE ZONE DATA

NOTE: SCS RUNOFF CURVE NUMBER WAS USER-SPECIFIED.

SCS RUNOFF CURVE NUMBER	=	98.00	
FRACTION OF AREA ALLOWING RUNOFF	=	100.0	PERCENT
AREA PROJECTED ON HORIZONTAL PLANE	=	1.000	ACRES
EVAPORATIVE ZONE DEPTH	=	0.7	INCHES
INITIAL WATER IN EVAPORATIVE ZONE	=	0.010	INCHES
UPPER LIMIT OF EVAPORATIVE STORAGE	=	0.378	INCHES
LOWER LIMIT OF EVAPORATIVE STORAGE	=	0.010	INCHES
INITIAL SNOW WATER	=	0.000	INCHES
INITIAL WATER IN LAYER MATERIALS	=	185.566	INCHES
TOTAL INITIAL WATER	=	185.566	INCHES
TOTAL SUBSURFACE INFLOW	=	0.00	INCHES/YEAR

EVAPOTRANSPIRATION AND WEATHER DATA

NOTE: EVAPOTRANSPIRATION DATA WAS OBTAINED FROM  
ATLANTA GEORGIA

STATION LATITUDE	=	33.65	DEGREES
MAXIMUM LEAF AREA INDEX	=	2.00	
START OF GROWING SEASON (JULIAN DATE)	=	77	
END OF GROWING SEASON (JULIAN DATE)	=	316	
EVAPORATIVE ZONE DEPTH	=	0.7	INCHES
AVERAGE ANNUAL WIND SPEED	=	9.10	MPH
AVERAGE 1ST QUARTER RELATIVE HUMIDITY	=	65.00	%
AVERAGE 2ND QUARTER RELATIVE HUMIDITY	=	67.00	%
AVERAGE 3RD QUARTER RELATIVE HUMIDITY	=	76.00	%
AVERAGE 4TH QUARTER RELATIVE HUMIDITY	=	69.00	%

NOTE: PRECIPITATION DATA WAS SYNTHETICALLY GENERATED USING  
COEFFICIENTS FOR ATLANTA GEORGIA

NORMAL MEAN MONTHLY PRECIPITATION (INCHES)

JAN/JUL	FEB/AUG	MAR/SEP	APR/OCT	MAY/NOV	JUN/DEC
4.91	4.43	5.91	4.43	4.02	3.41
4.73	3.41	3.17	2.53	3.43	4.23

NOTE: TEMPERATURE DATA WAS SYNTHETICALLY GENERATED USING  
COEFFICIENTS FOR ATLANTA GEORGIA

NORMAL MEAN MONTHLY TEMPERATURE (DEGREES FAHRENHEIT)

JAN/JUL	FEB/AUG	MAR/SEP	APR/OCT	MAY/NOV	JUN/DEC
41.90	44.90	52.50	61.80	69.30	75.80
78.60	78.20	73.00	62.20	52.00	44.50

MCDSGS18.txt

NOTE: SOLAR RADIATION DATA WAS SYNTHETICALLY GENERATED USING  
 COEFFICIENTS FOR ATLANTA GEORGIA  
 AND STATION LATITUDE = 33.65 DEGREES

HEAD #1: AVERAGE HEAD ON TOP OF LAYER 3  
 DRAIN #1: LATERAL DRAINAGE FROM LAYER 2 (RECIRCULATION AND COLLECTION)  
 LEAK #1: PERCOLATION OR LEAKAGE THROUGH LAYER 4  
 LEAK #2: PERCOLATION OR LEAKAGE THROUGH LAYER 5

\*\*\*\*\*  
 \*\*\*\*\*

DAI LY OUTPUT FOR YEAR 1

DAY	A	S	RAIN	RUNOFF	ET	E. ZONE	HEAD	DRAIN	LEAK	HEAD
DRAIN		O				WATER	#1	#1	#1	#2
	I	LEAK					IN.	IN.	IN.	IN.
#2	R	#2	IN.	IN.	IN.	IN./IN.				
IN.		IN.								
1			0.00	0.000	0.000	0.0143	0.0000	.0000E+00	.0000E+00	0.0000
.0000E+00			.0000E+00							
2			0.00	0.000	0.000	0.0143	0.0000	.0000E+00	.0000E+00	0.0000
.0000E+00			.0000E+00							
3			0.00	0.000	0.000	0.0143	0.0000	.0000E+00	.0000E+00	0.0000
.0000E+00			.0000E+00							
4			0.00	0.000	0.000	0.0143	0.0000	.0000E+00	.0000E+00	0.0000
.0000E+00			.0000E+00							
5			0.00	0.000	0.000	0.0143	0.0000	.0000E+00	.0000E+00	0.0000
.0000E+00			.0000E+00							
6			0.00	0.000	0.000	0.0143	0.0000	.0000E+00	.0000E+00	0.0000
.0000E+00			.0000E+00							
7			0.00	0.000	0.000	0.0143	0.0000	.0000E+00	.0000E+00	0.0000
.0000E+00			.0000E+00							
8			0.00	0.000	0.000	0.0143	0.0000	.0000E+00	.0000E+00	0.0000
.0000E+00			.0000E+00							
9			0.00	0.000	0.000	0.0143	0.0000	.0000E+00	.0000E+00	0.0000
.0000E+00			.0000E+00							
10			0.00	0.000	0.000	0.0143	0.0000	.0000E+00	.0000E+00	0.0000
.0000E+00			.0000E+00							
11			0.00	0.000	0.000	0.0143	0.0000	.0000E+00	.0000E+00	0.0000
.0000E+00			.0000E+00							
12			0.00	0.000	0.000	0.0143	0.0000	.0000E+00	.0000E+00	0.0000
.0000E+00			.0000E+00							
13			0.00	0.000	0.000	0.0143	0.0000	.0000E+00	.0000E+00	0.0000
.0000E+00			.0000E+00							
14	*		0.20	0.000	0.044	0.0403	0.0000	.1444E-02	.2535E-07	0.0000
.0000E+00			.0000E+00							
15	*		0.03	0.000	0.037	0.0682	0.0000	.1364E-03	.1173E-07	0.0000

\*\*\*\*\*

MONTHLY TOTALS (IN INCHES) FOR YEAR 30

	JAN/JUL	FEB/AUG	MAR/SEP	APR/OCT	MAY/NOV	JUN/DEC
PRECIPITATION	4.39 4.71	4.06 2.65	3.07 2.13	4.71 3.40	4.72 2.30	5.00 2.95
RUNOFF	2.753 2.934	2.606 1.457	1.937 0.922	2.091 1.531	3.080 1.023	2.388 1.388
EVAPOTRANSPIRATION	0.412 0.478	0.302 0.352	0.496 0.631	1.004 0.544	0.488 0.306	0.741 0.480
LATERAL DRAINAGE COLLECTED FROM LAYER 2	1.2248 1.3023	1.1488 0.9186	0.6398 0.5774	1.6150 1.3250	1.1523 0.9622	1.7896 1.0912
PERCOLATION/LEAKAGE THROUGH LAYER 4	0.0000 0.0000	0.0000 0.0000	0.0000 0.0000	0.0000 0.0000	0.0000 0.0000	0.0000 0.0000
PERCOLATION/LEAKAGE THROUGH LAYER 5	0.0000 0.0000	0.0000 0.0000	0.0000 0.0000	0.0000 0.0000	0.0000 0.0000	0.0000 0.0000

MONTHLY SUMMARIES FOR DAILY HEADS (INCHES)

AVERAGE DAILY HEAD ON TOP OF LAYER 3	0.000 0.000	0.000 0.000	0.000 0.000	0.000 0.000	0.000 0.000	0.001 0.000
STD. DEVIATION OF DAILY HEAD ON TOP OF LAYER 3	0.001 0.001	0.001 0.001	0.001 0.001	0.001 0.001	0.001 0.001	0.001 0.001

\*\*\*\*\*

\*\*\*\*\*

ANNUAL TOTALS FOR YEAR 30

	INCHES	CU. FEET	PERCENT
PRECIPITATION	44.09	160046.703	100.00
RUNOFF	24.110	87518.148	54.68
EVAPOTRANSPIRATION	6.233	22626.211	14.14
DRAINAGE COLLECTED FROM LAYER 2	13.7470	49901.781	31.18
PERC./LEAKAGE THROUGH LAYER 4	0.000154	0.559	0.00
AVG. HEAD ON TOP OF LAYER 3	0.0003		

MCDSGS18.txt

PERC. /LEAKAGE THROUGH LAYER 5	0.000000	0.000	0.00
CHANGE IN WATER STORAGE	0.000	0.554	0.00
SOIL WATER AT START OF YEAR	185.566	673603.812	
SOIL WATER AT END OF YEAR	185.566	673604.375	
SNOW WATER AT START OF YEAR	0.000	0.000	0.00
SNOW WATER AT END OF YEAR	0.000	0.000	0.00
ANNUAL WATER BUDGET BALANCE	0.0000	0.007	0.00

\*\*\*\*\*

\*\*\*\*\*

AVERAGE MONTHLY VALUES IN INCHES FOR YEARS 1 THROUGH 30

	JAN/JUL	FEB/AUG	MAR/SEP	APR/OCT	MAY/NOV	JUN/DEC
<b>PRECIPITATION</b>						
TOTALS	3.99 4.96	4.61 3.26	5.67 3.78	4.85 2.27	3.91 3.25	3.79 4.24
STD. DEVIATIONS	2.19 2.13	2.21 1.71	2.45 2.38	2.59 1.38	1.61 1.73	1.63 2.34
<b>RUNOFF</b>						
TOTALS	1.936 2.479	2.380 1.569	3.241 2.043	2.661 1.054	2.065 1.718	1.639 2.054
STD. DEVIATIONS	1.503 1.550	1.661 1.028	1.905 1.667	1.776 0.920	1.105 1.268	0.920 1.699
<b>EVAPOTRANSPIRATION</b>						
TOTALS	0.706 1.221	0.752 0.761	0.908 0.732	0.796 0.418	0.764 0.408	0.905 0.652
STD. DEVIATIONS	0.279 0.524	0.312 0.433	0.337 0.406	0.445 0.283	0.348 0.185	0.418 0.195
<b>LATERAL DRAINAGE COLLECTED FROM LAYER 2</b>						
TOTALS	1.4202 1.2673	1.4509 0.9315	1.5446 1.0157	1.3864 0.8061	1.1044 1.1033	1.2231 1.4875
STD. DEVIATIONS	0.6168 0.3722	0.5038 0.3690	0.4946 0.4901	0.4991 0.3892	0.3535 0.4206	0.4473 0.6812
<b>PERCOLATION/LEAKAGE THROUGH LAYER 4</b>						
TOTALS	0.0000	0.0000	0.0000	0.0000	0.0000	0.0000

MCDSGS18.txt

	0.0000	0.0000	0.0000	0.0000	0.0000	0.0000
STD. DEVIATIONS	0.0000	0.0000	0.0000	0.0000	0.0000	0.0000
	0.0000	0.0000	0.0000	0.0000	0.0000	0.0000
PERCOLATION/LEAKAGE THROUGH LAYER 5						
-----						
TOTALS	0.0000	0.0000	0.0000	0.0000	0.0000	0.0000
	0.0000	0.0000	0.0001	0.0000	0.0000	0.0000
STD. DEVIATIONS	0.0000	0.0000	0.0000	0.0000	0.0000	0.0000
	0.0000	0.0001	0.0002	0.0001	0.0001	0.0000

-----  
 AVERAGES OF MONTHLY AVERAGED DAILY HEADS (INCHES)  
 -----

DAILY AVERAGE HEAD ON TOP OF LAYER 3

AVERAGES	0.0004	0.0005	0.0005	0.0004	0.0003	0.0004
	0.0004	0.0003	0.0003	0.0002	0.0003	0.0004
STD. DEVIATIONS	0.0002	0.0002	0.0001	0.0002	0.0001	0.0001
	0.0001	0.0001	0.0001	0.0001	0.0001	0.0002

\*\*\*\*\*

\*\*\*\*\*

AVERAGE ANNUAL TOTALS & (STD. DEVIATIONS) FOR YEARS 1 THROUGH 30

	INCHES		CU. FEET	PERCENT
	-----	-----	-----	-----
PRECIPITATION	48.60	( 6.647)	176413.1	100.00
RUNOFF	24.837	( 4.5236)	90156.81	51.105
EVAPOTRANSPIRATION	9.021	( 1.5228)	32745.91	18.562
LATERAL DRAINAGE COLLECTED FROM LAYER 2	14.74100	( 1.57368)	53509.812	30.33210
PERCOLATION/LEAKAGE THROUGH LAYER 4	0.00017	( 0.00002)	0.606	0.00034
AVERAGE HEAD ON TOP OF LAYER 3	0.000	( 0.000)		
PERCOLATION/LEAKAGE THROUGH LAYER 5	0.00016	( 0.00033)	0.584	0.00033
CHANGE IN WATER STORAGE	0.000	( 0.4901)	0.02	0.000

\*\*\*\*\*

♀  
 \*\*\*\*\*



MCDSGS18. txt

PEAK DAILY VALUES FOR YEARS	1 THROUGH 30	
	(INCHES)	(CU. FT.)
PRECIPITATION	4.71	17097.301
RUNOFF	4.212	15289.8486
DRAINAGE COLLECTED FROM LAYER 2	0.44590	1618.62012
PERCOLATION/LEAKAGE THROUGH LAYER 4	0.000005	0.01679
AVERAGE HEAD ON TOP OF LAYER 3	0.004	
MAXIMUM HEAD ON TOP OF LAYER 3	0.132	
LOCATION OF MAXIMUM HEAD IN LAYER 2 (DISTANCE FROM DRAIN)	0.0 FEET	
PERCOLATION/LEAKAGE THROUGH LAYER 5	0.000804	2.91770
SNOW WATER	5.40	19602.5937
MAXIMUM VEG. SOIL WATER (VOL/VOL)		0.1397
MINIMUM VEG. SOIL WATER (VOL/VOL)		0.0143

\*\*\* Maximum heads are computed using McEnroe's equations. \*\*\*

Reference: Maximum Saturated Depth over Landfill Liner  
by Bruce M. McEnroe, University of Kansas  
ASCE Journal of Environmental Engineering  
Vol. 119, No. 2, March 1993, pp. 262-270.

\*\*\*\*\*

\*\*\*\*\*

FINAL WATER STORAGE AT END OF YEAR 30		
LAYER	(INCHES)	(VOL/VOL)
1	0.0087	0.0174
2	0.0017	0.0071
3	0.0000	0.0000
4	5.4360	0.4530
5	180.1196	0.1900
SNOW WATER	0.000	

\*\*\*\*\*



MCDSG2SL.txt

TYPE 1 - VERTICAL PERCOLATION LAYER

MATERIAL TEXTURE NUMBER 12

THICKNESS = 12.00 INCHES  
POROSITY = 0.4710 VOL/VOL  
FIELD CAPACITY = 0.3420 VOL/VOL  
WILTING POINT = 0.2100 VOL/VOL  
INITIAL SOIL WATER CONTENT = 0.3750 VOL/VOL  
EFFECTIVE SAT. HYD. COND. = 0.419999997000E-04 CM/SEC

LAYER 3

-----

TYPE 2 - LATERAL DRAINAGE LAYER

MATERIAL TEXTURE NUMBER 0

THICKNESS = 0.20 INCHES  
POROSITY = 0.8500 VOL/VOL  
FIELD CAPACITY = 0.0100 VOL/VOL  
WILTING POINT = 0.0050 VOL/VOL  
INITIAL SOIL WATER CONTENT = 0.0930 VOL/VOL  
EFFECTIVE SAT. HYD. COND. = 1.04999995000 CM/SEC  
SLOPE = 25.00 PERCENT  
DRAINAGE LENGTH = 400.0 FEET

LAYER 4

-----

TYPE 4 - FLEXIBLE MEMBRANE LINER

MATERIAL TEXTURE NUMBER 36

THICKNESS = 0.05 INCHES  
POROSITY = 0.0000 VOL/VOL  
FIELD CAPACITY = 0.0000 VOL/VOL  
WILTING POINT = 0.0000 VOL/VOL  
INITIAL SOIL WATER CONTENT = 0.0000 VOL/VOL  
EFFECTIVE SAT. HYD. COND. = 0.399999993000E-12 CM/SEC  
FML PINHOLE DENSITY = 1.00 HOLES/ACRE  
FML INSTALLATION DEFECTS = 1.00 HOLES/ACRE  
FML PLACEMENT QUALITY = 3 - GOOD

LAYER 5

-----

TYPE 3 - BARRIER SOIL LINER

MATERIAL TEXTURE NUMBER 6

THICKNESS = 12.00 INCHES  
POROSITY = 0.4530 VOL/VOL  
FIELD CAPACITY = 0.1900 VOL/VOL  
WILTING POINT = 0.0850 VOL/VOL  
INITIAL SOIL WATER CONTENT = 0.4530 VOL/VOL  
EFFECTIVE SAT. HYD. COND. = 0.720000011000E-03 CM/SEC

MCDSG2SL.txt  
LAYER 6  
-----

TYPE 1 - VERTICAL PERCOLATION LAYER  
MATERIAL TEXTURE NUMBER 6  
THICKNESS = 948.00 INCHES  
POROSITY = 0.4530 VOL/VOL  
FIELD CAPACITY = 0.1900 VOL/VOL  
WILTING POINT = 0.0850 VOL/VOL  
INITIAL SOIL WATER CONTENT = 0.1900 VOL/VOL  
EFFECTIVE SAT. HYD. COND. = 0.720000011000E-03 CM/SEC

GENERAL DESIGN AND EVAPORATIVE ZONE DATA  
-----

NOTE: SCS RUNOFF CURVE NUMBER WAS USER-SPECIFIED.

SCS RUNOFF CURVE NUMBER = 61.00  
FRACTION OF AREA ALLOWING RUNOFF = 100.0 PERCENT  
AREA PROJECTED ON HORIZONTAL PLANE = 1.000 ACRES  
EVAPORATIVE ZONE DEPTH = 10.0 INCHES  
INITIAL WATER IN EVAPORATIVE ZONE = 2.605 INCHES  
UPPER LIMIT OF EVAPORATIVE STORAGE = 4.662 INCHES  
LOWER LIMIT OF EVAPORATIVE STORAGE = 1.536 INCHES  
INITIAL SNOW WATER = 0.000 INCHES  
INITIAL WATER IN LAYER MATERIALS = 191.287 INCHES  
TOTAL INITIAL WATER = 191.287 INCHES  
TOTAL SUBSURFACE INFLOW = 0.00 INCHES/YEAR

EVAPOTRANSPIRATION AND WEATHER DATA  
-----

NOTE: EVAPOTRANSPIRATION DATA WAS OBTAINED FROM  
ATLANTA GEORGIA

STATION LATITUDE = 33.65 DEGREES  
MAXIMUM LEAF AREA INDEX = 2.00  
START OF GROWING SEASON (JULIAN DATE) = 77  
END OF GROWING SEASON (JULIAN DATE) = 316  
EVAPORATIVE ZONE DEPTH = 10.0 INCHES  
AVERAGE ANNUAL WIND SPEED = 9.10 MPH  
AVERAGE 1ST QUARTER RELATIVE HUMIDITY = 65.00 %  
AVERAGE 2ND QUARTER RELATIVE HUMIDITY = 67.00 %  
AVERAGE 3RD QUARTER RELATIVE HUMIDITY = 76.00 %  
AVERAGE 4TH QUARTER RELATIVE HUMIDITY = 69.00 %

NOTE: PRECIPITATION DATA WAS SYNTHETICALLY GENERATED USING  
COEFFICIENTS FOR ATLANTA GEORGIA

NORMAL MEAN MONTHLY PRECIPITATION (INCHES)

JAN/JUL	FEB/AUG	MAR/SEP	APR/OCT	MAY/NOV	JUN/DEC
4.91	4.43	5.91	4.43	4.02	3.41

4. 73            3. 41            3. 17            2. 53            3. 43            4. 23

NOTE: TEMPERATURE DATA WAS SYNTHETICALLY GENERATED USING  
COEFFICIENTS FOR ATLANTA GEORGIA

NORMAL MEAN MONTHLY TEMPERATURE (DEGREES FAHRENHEIT)

JAN/JUL	FEB/AUG	MAR/SEP	APR/OCT	MAY/NOV	JUN/DEC
41. 90	44. 90	52. 50	61. 80	69. 30	75. 80
78. 60	78. 20	73. 00	62. 20	52. 00	44. 50

NOTE: SOLAR RADIATION DATA WAS SYNTHETICALLY GENERATED USING  
COEFFICIENTS FOR ATLANTA GEORGIA  
AND STATION LATITUDE = 33. 65 DEGREES

HEAD #1: AVERAGE HEAD ON TOP OF LAYER 4  
DRAIN #1: LATERAL DRAINAGE FROM LAYER 3 (RECIRCULATION AND COLLECTION)  
LEAK #1: PERCOLATION OR LEAKAGE THROUGH LAYER 5  
LEAK #2: PERCOLATION OR LEAKAGE THROUGH LAYER 6

\*\*\*\*\*  
\*\*\*\*\*

DAI LY OUTPUT FOR YEAR 1

DAY	A	S	RAIN	RUNOFF	ET	E. ZONE	HEAD	DRAIN	LEAK	HEAD
DRAIN		0				WATER	#1	#1	#1	#2
#2	I	I					IN.	IN.	IN.	IN.
IN.	R	L	IN.	IN.	IN.	IN. /IN.	IN.	IN.	IN.	IN.
		IN.								
1		0. 00	0. 000	0. 055	0. 2519		0. 0189	. 6628E-01	. 1859E-04	0. 0000
. 0000E+00		. 0000E+00								
2		0. 00	0. 000	0. 051	0. 2446		0. 0160	. 5600E-01	. 1597E-04	0. 0000
. 0000E+00		. 0000E+00								
3		0. 00	0. 000	0. 053	0. 2384		0. 0152	. 5333E-01	. 1529E-04	0. 0000
. 0000E+00		. 0000E+00								
4		0. 00	0. 000	0. 040	0. 2344		0. 0143	. 4991E-01	. 1440E-04	0. 0000
. 0000E+00		. 0000E+00								
5		0. 00	0. 000	0. 050	0. 2294		0. 0110	. 3838E-01	. 1137E-04	0. 0000
. 0000E+00		. 0000E+00								
6		0. 00	0. 000	0. 063	0. 2231		0. 0089	. 3100E-01	. 9382E-05	0. 0000
. 0000E+00		. 0000E+00								
7		0. 00	0. 000	0. 056	0. 2175		0. 0074	. 2595E-01	. 7998E-05	0. 0000
. 0000E+00		. 0000E+00								

MCDSG2SL.txt

	INCHES	CU. FEET	PERCENT
PRECIPITATION	44.09	160046.703	100.00
RUNOFF	0.000	0.000	0.00
EVAPOTRANSPIRATION	30.154	109459.742	68.39
DRAINAGE COLLECTED FROM LAYER 3	14.2938	51886.387	32.42
PERC./LEAKAGE THROUGH LAYER 5	0.043305	157.197	0.10
AVG. HEAD ON TOP OF LAYER 4	0.2055		
PERC./LEAKAGE THROUGH LAYER 6	0.043381	157.471	0.10
CHANGE IN WATER STORAGE	-0.401	-1456.963	-0.91
SOIL WATER AT START OF YEAR	191.419	694850.437	
SOIL WATER AT END OF YEAR	191.017	693393.500	
SNOW WATER AT START OF YEAR	0.000	0.000	0.00
SNOW WATER AT END OF YEAR	0.000	0.000	0.00
ANNUAL WATER BUDGET BALANCE	0.0000	0.059	0.00

\*\*\*\*\*

\*\*\*\*\*

AVERAGE MONTHLY VALUES IN INCHES FOR YEARS 1 THROUGH 30

	JAN/JUL	FEB/AUG	MAR/SEP	APR/OCT	MAY/NOV	JUN/DEC
PRECIPITATION						
TOTALS	3.99 4.96	4.61 3.26	5.67 3.78	4.85 2.27	3.91 3.25	3.79 4.24
STD. DEVIATIONS	2.19 2.13	2.21 1.71	2.45 2.38	2.59 1.38	1.61 1.73	1.63 2.34
RUNOFF						
TOTALS	0.083 0.021	0.092 0.000	0.173 0.054	0.059 0.000	0.015 0.012	0.000 0.086
STD. DEVIATIONS	0.305 0.113	0.399 0.000	0.495 0.202	0.308 0.000	0.080 0.052	0.000 0.332
EVAPOTRANSPIRATION						
TOTALS	1.804 4.115	2.054 3.124	3.320 2.581	3.478 1.624	3.347 1.451	3.397 1.503

MCDSG2SL.txt

STD. DEVIATIONS            0.238    0.367    0.493    1.009    0.889    1.431  
                                  1.221    1.250    1.283    0.466    0.277    0.210

LATERAL DRAINAGE COLLECTED FROM LAYER 3

TOTALS                        2.4517   2.3119   2.5232   1.5007   1.0559   0.2374  
                                  0.6195   0.2009   0.8515   0.8190   1.2369   2.3598

STD. DEVIATIONS            2.1231   1.9048   1.7752   1.1959   1.2013   0.3141  
                                  1.0164   0.2822   1.1846   1.1747   1.4237   2.0578

PERCOLATION/LEAKAGE THROUGH LAYER 5

TOTALS                        0.0073   0.0091   0.0071   0.0045   0.0026   0.0001  
                                  0.0011   0.0001   0.0019   0.0023   0.0034   0.0077

STD. DEVIATIONS            0.0110   0.0147   0.0092   0.0072   0.0048   0.0002  
                                  0.0029   0.0001   0.0051   0.0073   0.0059   0.0129

PERCOLATION/LEAKAGE THROUGH LAYER 6

TOTALS                        0.0071   0.0061   0.0099   0.0059   0.0038   0.0007  
                                  0.0010   0.0001   0.0013   0.0025   0.0029   0.0058

STD. DEVIATIONS            0.0120   0.0090   0.0105   0.0119   0.0072   0.0036  
                                  0.0028   0.0004   0.0034   0.0065   0.0047   0.0068

-----  
 AVERAGES OF MONTHLY AVERAGED DAILY HEADS (INCHES)  
 -----

DAI LY AVERAGE HEAD ON TOP OF LAYER 4

AVERAGES                    0.4066   0.5573   0.3900   0.2549   0.1439   0.0033  
                                  0.0567   0.0019   0.1048   0.1296   0.1923   0.4284

STD. DEVIATIONS            0.6219   0.9242   0.5222   0.4192   0.2698   0.0082  
                                  0.1619   0.0026   0.2978   0.4136   0.3404   0.7340

\*\*\*\*\*

\*\*\*\*\*

AVERAGE ANNUAL TOTALS & (STD. DEVIATIONS) FOR YEARS 1 THROUGH 30

	INCHES		CU. FEET	PERCENT
PRECIPI TATI ON	48.60	( 6.647)	176413.1	100.00
RUNOFF	0.595	( 0.8378)	2160.72	1.225
EVAPOTRANSPI RATI ON	31.797	( 2.9534)	115422.42	65.427
LATERAL DRAI NAGE COLLECTED FROM LAYER 3	16.16854	( 4.81010)	58691.816	33.26953
PERCOLATI ON/LEAKAGE THROUGH LAYER 5	0.04707	( 0.02786)	170.861	0.09685

MCDSG2SL.txt

AVERAGE HEAD ON TOP OF LAYER 4	0.222 ( 0.137)		
PERCOLATION/LEAKAGE THROUGH LAYER 6	0.04705 ( 0.02790)	170.785	0.09681
CHANGE IN WATER STORAGE	-0.009 ( 0.9941)	-32.60	-0.018

\*\*\*\*\*

\*\*\*\*\*

PEAK DAILY VALUES FOR YEARS	1 THROUGH	30
	(INCHES)	(CU. FT.)
PRECIPITATION	4.71	17097.301
RUNOFF	1.954	7093.9360
DRAINAGE COLLECTED FROM LAYER 3	0.71877	2609.13184
PERCOLATION/LEAKAGE THROUGH LAYER 5	0.009840	35.72081
AVERAGE HEAD ON TOP OF LAYER 4	17.403	
MAXIMUM HEAD ON TOP OF LAYER 4	32.156	
LOCATION OF MAXIMUM HEAD IN LAYER 3 (DISTANCE FROM DRAIN)	7.4 FEET	
PERCOLATION/LEAKAGE THROUGH LAYER 6	0.004105	14.90285
SNOW WATER	5.40	19602.5937
MAXIMUM VEG. SOIL WATER (VOL/VOL)		0.4662
MINIMUM VEG. SOIL WATER (VOL/VOL)		0.1536

\*\*\* Maximum heads are computed using McEnroe's equations. \*\*\*

Reference: Maximum Saturated Depth over Landfill Liner  
 by Bruce M. McEnroe, University of Kansas  
 ASCE Journal of Environmental Engineering  
 Vol. 119, No. 2, March 1993, pp. 262-270.

\*\*\*\*\*

\*\*\*\*\*

FINAL WATER STORAGE AT END OF YEAR 30



LAYER	MCD2SG2SL.txt (INCHES)	(VOL/VOL)
1	1.1364	0.1894
2	4.3172	0.3598
3	0.0086	0.0430
4	0.0000	0.0000
5	5.4360	0.4530
6	180.1193	0.1900
SNOW WATER	0.000	

\*\*\*\*\*  
\*\*\*\*\*



MDCCCR2.TXT

TYPE 3 - BARRIER SOIL LINER  
MATERIAL TEXTURE NUMBER 0

THICKNESS = 18.00 INCHES  
POROSITY = 0.4710 VOL/VOL  
FIELD CAPACITY = 0.3420 VOL/VOL  
WILTING POINT = 0.2100 VOL/VOL  
INITIAL SOIL WATER CONTENT = 0.4710 VOL/VOL  
EFFECTIVE SAT. HYD. COND. = 0.999999975000E-05 CM/SEC

LAYER 3  
-----

TYPE 1 - VERTICAL PERCOLATION LAYER  
MATERIAL TEXTURE NUMBER 6

THICKNESS = 948.00 INCHES  
POROSITY = 0.4530 VOL/VOL  
FIELD CAPACITY = 0.1900 VOL/VOL  
WILTING POINT = 0.0850 VOL/VOL  
INITIAL SOIL WATER CONTENT = 0.2088 VOL/VOL  
EFFECTIVE SAT. HYD. COND. = 0.720000011000E-03 CM/SEC

GENERAL DESIGN AND EVAPORATIVE ZONE DATA  
-----

NOTE: SCS RUNOFF CURVE NUMBER WAS USER-SPECIFIED.

SCS RUNOFF CURVE NUMBER = 61.00  
FRACTION OF AREA ALLOWING RUNOFF = 100.0 PERCENT  
AREA PROJECTED ON HORIZONTAL PLANE = 1.000 ACRES  
EVAPORATIVE ZONE DEPTH = 6.0 INCHES  
INITIAL WATER IN EVAPORATIVE ZONE = 1.094 INCHES  
UPPER LIMIT OF EVAPORATIVE STORAGE = 2.778 INCHES  
LOWER LIMIT OF EVAPORATIVE STORAGE = 0.696 INCHES  
INITIAL SNOW WATER = 0.000 INCHES  
INITIAL WATER IN LAYER MATERIALS = 207.521 INCHES  
TOTAL INITIAL WATER = 207.521 INCHES  
TOTAL SUBSURFACE INFLOW = 0.00 INCHES/YEAR

EVAPOTRANSPIRATION AND WEATHER DATA  
-----

NOTE: EVAPOTRANSPIRATION DATA WAS OBTAINED FROM  
ATLANTA GEORGIA

STATION LATITUDE = 33.65 DEGREES  
MAXIMUM LEAF AREA INDEX = 2.00  
START OF GROWING SEASON (JULIAN DATE) = 77  
END OF GROWING SEASON (JULIAN DATE) = 316  
EVAPORATIVE ZONE DEPTH = 6.0 INCHES  
AVERAGE ANNUAL WIND SPEED = 9.10 MPH  
AVERAGE 1ST QUARTER RELATIVE HUMIDITY = 65.00 %  
AVERAGE 2ND QUARTER RELATIVE HUMIDITY = 67.00 %

MCDCCR2.TXT

AVERAGE 3RD QUARTER RELATIVE HUMIDITY = 76.00 %  
 AVERAGE 4TH QUARTER RELATIVE HUMIDITY = 69.00 %

NOTE: PRECIPITATION DATA WAS SYNTHETICALLY GENERATED USING  
 COEFFICIENTS FOR ATLANTA GEORGIA

NORMAL MEAN MONTHLY PRECIPITATION (INCHES)

JAN/JUL	FEB/AUG	MAR/SEP	APR/OCT	MAY/NOV	JUN/DEC
4.91	4.43	5.91	4.43	4.02	3.41
4.73	3.41	3.17	2.53	3.43	4.23

NOTE: TEMPERATURE DATA WAS SYNTHETICALLY GENERATED USING  
 COEFFICIENTS FOR ATLANTA GEORGIA

NORMAL MEAN MONTHLY TEMPERATURE (DEGREES FAHRENHEIT)

JAN/JUL	FEB/AUG	MAR/SEP	APR/OCT	MAY/NOV	JUN/DEC
41.90	44.90	52.50	61.80	69.30	75.80
78.60	78.20	73.00	62.20	52.00	44.50

NOTE: SOLAR RADIATION DATA WAS SYNTHETICALLY GENERATED USING  
 COEFFICIENTS FOR ATLANTA GEORGIA  
 AND STATION LATITUDE = 33.65 DEGREES

- HEAD #1: AVERAGE HEAD ON TOP OF LAYER 2
- DRAIN #1: LATERAL DRAINAGE FROM LAYER 1 (RECIRCULATION AND COLLECTION)
- LEAK #1: PERCOLATION OR LEAKAGE THROUGH LAYER 2
- LEAK #2: PERCOLATION OR LEAKAGE THROUGH LAYER 3

\*\*\*\*\*  
 \*\*\*\*\*

DAILY OUTPUT FOR YEAR 1

DAY	A	S	RAIN	RUNOFF	ET	E. ZONE	HEAD	DRAIN	LEAK	HEAD
DRAIN	I	LEAK				WATER	#1	#1	#1	#2
#2	R	#2	IN.	IN.	IN.	IN. /IN.	IN.	IN.	IN.	IN.
IN.		IN.								

1 0.00 0.000 0.057 0.1729 0.0000 .0000E+00 .0000E+00 0.0000

	MCDCCR2.TXT		
PERC. /LEAKAGE THROUGH LAYER 2	16.097435	58433.687	36.51
AVG. HEAD ON TOP OF LAYER 2	0.2481		
PERC. /LEAKAGE THROUGH LAYER 3	17.811485	64655.691	40.40
CHANGE IN WATER STORAGE	-1.907	-6923.842	-4.33
SOIL WATER AT START OF YEAR	246.118	893410.125	
SOIL WATER AT END OF YEAR	244.211	886486.312	
SNOW WATER AT START OF YEAR	0.000	0.000	0.00
SNOW WATER AT END OF YEAR	0.000	0.000	0.00
ANNUAL WATER BUDGET BALANCE	0.0000	0.055	0.00

\*\*\*\*\*

\*\*\*\*\*

AVERAGE MONTHLY VALUES IN INCHES FOR YEARS 1 THROUGH 30

	JAN/JUL	FEB/AUG	MAR/SEP	APR/OCT	MAY/NOV	JUN/DEC
<b>PRECIPITATION</b>						
TOTALS	3.99 4.96	4.61 3.26	5.67 3.78	4.85 2.27	3.91 3.25	3.79 4.24
STD. DEVIATIONS	2.19 2.13	2.21 1.71	2.45 2.38	2.59 1.38	1.61 1.73	1.63 2.34
<b>RUNOFF</b>						
TOTALS	0.340 0.109	0.450 0.000	0.497 0.196	0.348 0.059	0.189 0.193	0.000 0.293
STD. DEVIATIONS	0.738 0.327	0.921 0.000	0.926 0.558	0.675 0.219	0.381 0.408	0.000 0.827
<b>EVAPOTRANSPIRATION</b>						
TOTALS	1.655 3.624	1.851 2.600	2.761 2.256	2.849 1.393	2.612 1.430	2.943 1.467
STD. DEVIATIONS	0.291 1.036	0.466 0.976	0.632 1.147	0.906 0.493	0.776 0.291	1.225 0.259
<b>PERCOLATION/LEAKAGE THROUGH LAYER 2</b>						
TOTALS	2.2258 1.1720	2.2432 0.6575	2.4603 1.3523	1.7338 0.8995	1.3416 1.3531	0.6587 2.3870
STD. DEVIATIONS	1.7759 1.1377	1.4823 0.7004	1.4541 1.1853	1.1805 1.0308	0.9374 1.2602	0.5109 1.8109

MCDCCR2.TXT

PERCOLATION/LEAKAGE THROUGH LAYER 3

TOTALS	1.1347	1.1664	1.1579	1.4544	1.6286	1.7181
	1.7196	1.6642	1.4776	1.4749	1.3994	1.2645
STD. DEVIATIONS	0.6071	0.5225	0.6145	0.7082	0.7281	0.7019
	0.6029	0.4726	0.4514	0.5870	0.4882	0.4660

AVERAGES OF MONTHLY AVERAGED DAILY HEADS (INCHES)

DAILY AVERAGE HEAD ON TOP OF LAYER 2

AVERAGES	0.3077	0.4521	0.4447	0.3005	0.2445	0.0789
	0.1929	0.0679	0.2467	0.1377	0.2528	0.3788
STD. DEVIATIONS	0.3048	0.4442	0.3369	0.2691	0.2674	0.0807
	0.2690	0.0964	0.2881	0.2370	0.3022	0.3916

\*\*\*\*\*

\*\*\*\*\*

AVERAGE ANNUAL TOTALS & (STD. DEVIATIONS) FOR YEARS 1 THROUGH 30

	INCHES		CU. FEET	PERCENT
PRECIPITATION	48.60	( 6.647)	176413.1	100.00
RUNOFF	2.675	( 2.1379)	9711.14	5.505
EVAPOTRANSPIRATION	27.440	( 2.7693)	99607.50	56.463
PERCOLATION/LEAKAGE THROUGH LAYER 2	18.48482	( 4.51527)	67099.891	38.03566
AVERAGE HEAD ON TOP OF LAYER 2	0.259	( 0.084)		
PERCOLATION/LEAKAGE THROUGH LAYER 3	17.26032	( 4.89562)	62654.957	35.51604
CHANGE IN WATER STORAGE	1.223	( 6.2957)	4439.57	2.517

\*\*\*\*\*

♀

\*\*\*\*\*

PEAK DAILY VALUES FOR YEARS 1 THROUGH 30

	(INCHES)	(CU. FT.)
PRECIPITATION	4.71	17097.301

MDCCCR2.TXT

RUNOFF		3.422	12422.7168
PERCOLATION/LEAKAGE THROUGH LAYER	2	0.453537	1646.34021
AVERAGE HEAD ON TOP OF LAYER	2	6.000	
PERCOLATION/LEAKAGE THROUGH LAYER	3	0.218412	792.83582
SNOW WATER		5.40	19602.5937
MAXIMUM VEG. SOIL WATER (VOL/VOL)			0.4630
MINIMUM VEG. SOIL WATER (VOL/VOL)			0.1160

\*\*\*\*\*

♀  
†

\*\*\*\*\*

FINAL WATER STORAGE AT END OF YEAR 30

LAYER	(INCHES)	(VOL/VOL)
1	1.0498	0.1750
2	8.4780	0.4710
3	234.6834	0.2476
SNOW WATER	0.000	

\*\*\*\*\*  
\*\*\*\*\*

```

*****
*****
**
**
**
HYDROLOGIC EVALUATION OF LANDFILL PERFORMANCE
HELP MODEL VERSION 3.07 (1 NOVEMBER 1997)
DEVELOPED BY ENVIRONMENTAL LABORATORY
USAE WATERWAYS EXPERIMENT STATION
FOR USEPA RISK REDUCTION ENGINEERING LABORATORY
**
**
**
*****
*****

```

```

PRECIPITATION DATA FILE: C:\MCD1118.D4
TEMPERATURE DATA FILE: C:\MCD1118.D7
SOLAR RADIATION DATA FILE: C:\MCD1118.D13
EVAPOTRANSPIRATION DATA: C:\MCD1118.D11
SOIL AND DESIGN DATA FILE: C:\MCDMSTDC.D10
OUTPUT DATA FILE: C:\MCDTDCT.OUT

```

TIME: 21:40 DATE: 11/ 7/2018

```

*****
**

```

TITLE: Plant McDonough Closure Turf & MicroSpike Top Deck

```

*****

```

NOTE: INITIAL MOISTURE CONTENT OF THE LAYERS AND SNOW WATER WERE COMPUTED AS NEARLY STEADY-STATE VALUES BY THE PROGRAM.

LAYER 1  
-----

```

TYPE 1 - VERTICAL PERCOLATION LAYER
MATERIAL TEXTURE NUMBER 1
THICKNESS = 0.50 INCHES
POROSITY = 0.4170 VOL/VOL
FIELD CAPACITY = 0.0450 VOL/VOL
WILTING POINT = 0.0180 VOL/VOL
INITIAL SOIL WATER CONTENT = 0.0174 VOL/VOL
EFFECTIVE SAT. HYD. COND. = 0.99999978000E-02 CM/SEC
NOTE: SATURATED HYDRAULIC CONDUCTIVITY IS MULTIPLIED BY 3.00
FOR ROOT CHANNELS IN TOP HALF OF EVAPORATIVE ZONE.

```

LAYER 2  
-----  
Page 1



MCDTDCT.txt

TYPE 2 - LATERAL DRAINAGE LAYER

MATERIAL TEXTURE NUMBER 34

THICKNESS	=	0.24	INCHES
POROSITY	=	0.8500	VOL/VOL
FIELD CAPACITY	=	0.0100	VOL/VOL
WILTING POINT	=	0.0050	VOL/VOL
INITIAL SOIL WATER CONTENT	=	0.0071	VOL/VOL
EFFECTIVE SAT. HYD. COND.	=	33.0000000000	CM/SEC
SLOPE	=	3.00	PERCENT
DRAINAGE LENGTH	=	275.0	FEET

LAYER 3

-----

TYPE 4 - FLEXIBLE MEMBRANE LINER

MATERIAL TEXTURE NUMBER 36

THICKNESS	=	0.04	INCHES
POROSITY	=	0.0000	VOL/VOL
FIELD CAPACITY	=	0.0000	VOL/VOL
WILTING POINT	=	0.0000	VOL/VOL
INITIAL SOIL WATER CONTENT	=	0.0000	VOL/VOL
EFFECTIVE SAT. HYD. COND.	=	0.399999993000E-12	CM/SEC
FML PINHOLE DENSITY	=	1.00	HOLES/ACRE
FML INSTALLATION DEFECTS	=	1.00	HOLES/ACRE
FML PLACEMENT QUALITY	=	3 - GOOD	

LAYER 4

-----

TYPE 3 - BARRIER SOIL LINER

MATERIAL TEXTURE NUMBER 6

THICKNESS	=	12.00	INCHES
POROSITY	=	0.4530	VOL/VOL
FIELD CAPACITY	=	0.1900	VOL/VOL
WILTING POINT	=	0.0850	VOL/VOL
INITIAL SOIL WATER CONTENT	=	0.4530	VOL/VOL
EFFECTIVE SAT. HYD. COND.	=	0.720000011000E-03	CM/SEC

LAYER 5

-----

TYPE 1 - VERTICAL PERCOLATION LAYER

MATERIAL TEXTURE NUMBER 6

THICKNESS	=	948.00	INCHES
POROSITY	=	0.4530	VOL/VOL
FIELD CAPACITY	=	0.1900	VOL/VOL
WILTING POINT	=	0.0850	VOL/VOL
INITIAL SOIL WATER CONTENT	=	0.1900	VOL/VOL
EFFECTIVE SAT. HYD. COND.	=	0.720000011000E-03	CM/SEC

GENERAL DESIGN AND EVAPORATIVE ZONE DATA

NOTE: SCS RUNOFF CURVE NUMBER WAS USER-SPECIFIED.

SCS RUNOFF CURVE NUMBER	=	98.00	
FRACTION OF AREA ALLOWING RUNOFF	=	100.0	PERCENT
AREA PROJECTED ON HORIZONTAL PLANE	=	1.000	ACRES
EVAPORATIVE ZONE DEPTH	=	0.7	INCHES
INITIAL WATER IN EVAPORATIVE ZONE	=	0.010	INCHES
UPPER LIMIT OF EVAPORATIVE STORAGE	=	0.378	INCHES
LOWER LIMIT OF EVAPORATIVE STORAGE	=	0.010	INCHES
INITIAL SNOW WATER	=	0.000	INCHES
INITIAL WATER IN LAYER MATERIALS	=	185.566	INCHES
TOTAL INITIAL WATER	=	185.566	INCHES
TOTAL SUBSURFACE INFLOW	=	0.00	INCHES/YEAR

EVAPOTRANSPIRATION AND WEATHER DATA

NOTE: EVAPOTRANSPIRATION DATA WAS OBTAINED FROM ATLANTA GEORGIA

STATION LATITUDE	=	33.65	DEGREES
MAXIMUM LEAF AREA INDEX	=	2.00	
START OF GROWING SEASON (JULIAN DATE)	=	77	
END OF GROWING SEASON (JULIAN DATE)	=	316	
EVAPORATIVE ZONE DEPTH	=	0.7	INCHES
AVERAGE ANNUAL WIND SPEED	=	9.10	MPH
AVERAGE 1ST QUARTER RELATIVE HUMIDITY	=	65.00	%
AVERAGE 2ND QUARTER RELATIVE HUMIDITY	=	67.00	%
AVERAGE 3RD QUARTER RELATIVE HUMIDITY	=	76.00	%
AVERAGE 4TH QUARTER RELATIVE HUMIDITY	=	69.00	%

NOTE: PRECIPITATION DATA WAS SYNTHETICALLY GENERATED USING COEFFICIENTS FOR ATLANTA GEORGIA

NORMAL MEAN MONTHLY PRECIPITATION (INCHES)

JAN/JUL	FEB/AUG	MAR/SEP	APR/OCT	MAY/NOV	JUN/DEC
4.91	4.43	5.91	4.43	4.02	3.41
4.73	3.41	3.17	2.53	3.43	4.23

NOTE: TEMPERATURE DATA WAS SYNTHETICALLY GENERATED USING COEFFICIENTS FOR ATLANTA GEORGIA

NORMAL MEAN MONTHLY TEMPERATURE (DEGREES FAHRENHEIT)

JAN/JUL	FEB/AUG	MAR/SEP	APR/OCT	MAY/NOV	JUN/DEC
41.90	44.90	52.50	61.80	69.30	75.80
78.60	78.20	73.00	62.20	52.00	44.50

NOTE: SOLAR RADIATION DATA WAS SYNTHETICALLY GENERATED USING  
 COEFFICIENTS FOR ATLANTA GEORGIA  
 AND STATION LATITUDE = 33.65 DEGREES

HEAD #1: AVERAGE HEAD ON TOP OF LAYER 3  
 DRAIN #1: LATERAL DRAINAGE FROM LAYER 2 (RECIRCULATION AND COLLECTION)  
 LEAK #1: PERCOLATION OR LEAKAGE THROUGH LAYER 4  
 LEAK #2: PERCOLATION OR LEAKAGE THROUGH LAYER 5

\*\*\*\*\*  
 \*\*\*\*\*

DAI LY OUTPUT FOR YEAR 1

DAY	A	S	RAIN	RUNOFF	ET	E. ZONE	HEAD	DRAIN	LEAK	HEAD
DRAIN	I	O	IN.	IN.	IN.	IN. /IN.	#1	#1	#1	#2
#2	R	L	IN.	IN.	IN.	IN. /IN.	IN.	IN.	IN.	IN.
IN.	I	I	IN.	IN.	IN.	IN. /IN.	IN.	IN.	IN.	IN.
1			0.00	0.000	0.000	0.0143	0.0000	.0000E+00	.0000E+00	0.0000
.0000E+00			.0000E+00							
2			0.00	0.000	0.000	0.0143	0.0000	.0000E+00	.0000E+00	0.0000
.0000E+00			.0000E+00							
3			0.00	0.000	0.000	0.0143	0.0000	.0000E+00	.0000E+00	0.0000
.0000E+00			.0000E+00							
4			0.00	0.000	0.000	0.0143	0.0000	.0000E+00	.0000E+00	0.0000
.0000E+00			.0000E+00							
5			0.00	0.000	0.000	0.0143	0.0000	.0000E+00	.0000E+00	0.0000
.0000E+00			.0000E+00							
6			0.00	0.000	0.000	0.0143	0.0000	.0000E+00	.0000E+00	0.0000
.0000E+00			.0000E+00							
7			0.00	0.000	0.000	0.0143	0.0000	.0000E+00	.0000E+00	0.0000
.0000E+00			.0000E+00							
8			0.00	0.000	0.000	0.0143	0.0000	.0000E+00	.0000E+00	0.0000
.0000E+00			.0000E+00							
9			0.00	0.000	0.000	0.0143	0.0000	.0000E+00	.0000E+00	0.0000
.0000E+00			.0000E+00							
10			0.00	0.000	0.000	0.0143	0.0000	.0000E+00	.0000E+00	0.0000
.0000E+00			.0000E+00							
11			0.00	0.000	0.000	0.0143	0.0000	.0000E+00	.0000E+00	0.0000
.0000E+00			.0000E+00							
12			0.00	0.000	0.000	0.0143	0.0000	.0000E+00	.0000E+00	0.0000
.0000E+00			.0000E+00							
13			0.00	0.000	0.000	0.0143	0.0000	.0000E+00	.0000E+00	0.0000
.0000E+00			.0000E+00							
14 *			0.20	0.000	0.044	0.0423	0.0000	.6951E-04	.8305E-08	0.0000
.0000E+00			.0000E+00							
15 *			0.03	0.000	0.037	0.0700	0.0000	.3132E-03	.2437E-07	0.0000

	MCDTDC.T.txt		
PERC. /LEAKAGE THROUGH LAYER 5	0.000802	2.913	0.00
CHANGE IN WATER STORAGE	0.000	-0.388	0.00
SOIL WATER AT START OF YEAR	185.566	673603.875	
SOIL WATER AT END OF YEAR	185.566	673603.500	
SNOW WATER AT START OF YEAR	0.000	0.000	0.00
SNOW WATER AT END OF YEAR	0.000	0.000	0.00
ANNUAL WATER BUDGET BALANCE	0.0000	0.000	0.00

\*\*\*\*\*

\*\*\*\*\*

AVERAGE MONTHLY VALUES IN INCHES FOR YEARS 1 THROUGH 30

	JAN/JUL	FEB/AUG	MAR/SEP	APR/OCT	MAY/NOV	JUN/DEC
<b>PRECIPITATION</b>						
TOTALS	3.99 4.96	4.61 3.26	5.67 3.78	4.85 2.27	3.91 3.25	3.79 4.24
STD. DEVIATIONS	2.19 2.13	2.21 1.71	2.45 2.38	2.59 1.38	1.61 1.73	1.63 2.34
<b>RUNOFF</b>						
TOTALS	1.944 2.488	2.393 1.574	3.256 2.053	2.673 1.058	2.075 1.725	1.644 2.064
STD. DEVIATIONS	1.510 1.552	1.670 1.032	1.911 1.677	1.793 0.922	1.110 1.272	0.924 1.711
<b>EVAPOTRANSPIRATION</b>						
TOTALS	0.689 1.229	0.736 0.758	0.880 0.719	0.773 0.422	0.729 0.392	0.897 0.636
STD. DEVIATIONS	0.272 0.524	0.303 0.438	0.334 0.394	0.420 0.277	0.342 0.177	0.400 0.190
<b>LATERAL DRAINAGE COLLECTED FROM LAYER 2</b>						
TOTALS	1.4308 1.2526	1.4512 0.9274	1.5554 1.0182	1.3988 0.7997	1.1311 1.1103	1.2225 1.4921
STD. DEVIATIONS	0.6244 0.3745	0.5031 0.3665	0.4960 0.4982	0.5054 0.3888	0.3509 0.4215	0.4463 0.6760
<b>PERCOLATION/LEAKAGE THROUGH LAYER 4</b>						
TOTALS	0.0001	0.0001	0.0001	0.0001	0.0001	0.0001

MCDTDCT.txt

	0.0001	0.0000	0.0001	0.0000	0.0001	0.0001
STD. DEVIATIONS	0.0000	0.0000	0.0000	0.0000	0.0000	0.0000
	0.0000	0.0000	0.0000	0.0000	0.0000	0.0000
PERCOLATION/LEAKAGE THROUGH LAYER 5						
TOTALS	0.0001	0.0001	0.0001	0.0001	0.0001	0.0001
	0.0000	0.0000	0.0001	0.0000	0.0000	0.0001
STD. DEVIATIONS	0.0002	0.0002	0.0002	0.0002	0.0003	0.0003
	0.0001	0.0000	0.0002	0.0000	0.0001	0.0003

-----  
 AVERAGES OF MONTHLY AVERAGED DAILY HEADS (INCHES)  
 -----

DAILY AVERAGE HEAD ON TOP OF LAYER 3

AVERAGES	0.0023	0.0025	0.0025	0.0023	0.0018	0.0020
	0.0020	0.0015	0.0017	0.0013	0.0018	0.0024
STD. DEVIATIONS	0.0010	0.0009	0.0008	0.0008	0.0006	0.0007
	0.0006	0.0006	0.0008	0.0006	0.0007	0.0011

\*\*\*\*\*

\*\*\*\*\*

AVERAGE ANNUAL TOTALS & (STD. DEVIATIONS) FOR YEARS 1 THROUGH 30

	INCHES		CU. FEET	PERCENT
PRECIPITATION	48.60	( 6.647)	176413.1	100.00
RUNOFF	24.948	( 4.5447)	90560.19	51.334
EVAPOTRANSPIRATION	8.860	( 1.5094)	32162.26	18.231
LATERAL DRAINAGE COLLECTED FROM LAYER 2	14.79008	( 1.55873)	53687.984	30.43310
PERCOLATION/LEAKAGE THROUGH LAYER 4	0.00076	( 0.00008)	2.742	0.00155
AVERAGE HEAD ON TOP OF LAYER 3	0.002	( 0.000)		
PERCOLATION/LEAKAGE THROUGH LAYER 5	0.00078	( 0.00033)	2.819	0.00160
CHANGE IN WATER STORAGE	0.000	( 0.4939)	-0.08	0.000

\*\*\*\*\*

\*\*\*\*\*

PEAK DAILY VALUES FOR YEARS	1 THROUGH	30
	(INCHES)	(CU. FT.)
PRECIPITATION	4.71	17097.301
RUNOFF	4.209	15280.4375
DRAINAGE COLLECTED FROM LAYER 2	0.40115	1456.18042
PERCOLATION/LEAKAGE THROUGH LAYER 4	0.000019	0.06897
AVERAGE HEAD ON TOP OF LAYER 3	0.020	
MAXIMUM HEAD ON TOP OF LAYER 3	0.039	
LOCATION OF MAXIMUM HEAD IN LAYER 2 (DISTANCE FROM DRAIN)	3.7 FEET	
PERCOLATION/LEAKAGE THROUGH LAYER 5	0.000806	2.92590
SNOW WATER	5.40	19602.5937
MAXIMUM VEG. SOIL WATER (VOL/VOL)		0.1850
MINIMUM VEG. SOIL WATER (VOL/VOL)		0.0143

\*\*\* Maximum heads are computed using McEnroe's equations. \*\*\*

Reference: Maximum Saturated Depth over Landfill Liner  
by Bruce M. McEnroe, University of Kansas  
ASCE Journal of Environmental Engineering  
Vol. 119, No. 2, March 1993, pp. 262-270.

\*\*\*\*\*

\*\*\*\*\*

FINAL WATER STORAGE AT END OF YEAR 30		
LAYER	(INCHES)	(VOL/VOL)
1	0.0087	0.0174
2	0.0017	0.0071
3	0.0000	0.0000
4	5.4360	0.4530
5	180.1193	0.1900
SNOW WATER	0.000	

\*\*\*\*\*

```

*****
*****
**
**
**
**      HYDROLOGIC EVALUATION OF LANDFILL PERFORMANCE      **
**      HELP MODEL VERSION 3.07 (1 NOVEMBER 1997)          **
**      DEVELOPED BY ENVIRONMENTAL LABORATORY              **
**      USAE WATERWAYS EXPERIMENT STATION                 **
**      FOR USEPA RISK REDUCTION ENGINEERING LABORATORY   **
**
**
*****
*****

```

```

PRECIPITATION DATA FILE:   C:\MCD1810.D4
TEMPERATURE DATA FILE:    C:\MCD1810.D7
SOLAR RADIATION DATA FILE: C:\MCD1810.D13
EVAPOTRANSPIRATION DATA:  C:\MCD1810.D11
SOIL AND DESIGN DATA FILE: C:\MCDMTN18.D10
OUTPUT DATA FILE:         C:\MCDmtn18.OUT

```

TIME: 22:12      DATE: 11/ 7/2018

```

*****
**

```

TITLE: Plant McDonough Soil Liner Cover Top Deck Nov 2018

```

*****

```

NOTE: INITIAL MOISTURE CONTENT OF THE LAYERS AND SNOW WATER WERE  
COMPUTED AS NEARLY STEADY-STATE VALUES BY THE PROGRAM.

LAYER 1  
-----

```

          TYPE 1 - VERTICAL PERCOLATION LAYER
          MATERIAL TEXTURE NUMBER 8
THICKNESS           = 6.00 INCHES
POROSITY             = 0.4630 VOL/VOL
FIELD CAPACITY      = 0.2320 VOL/VOL
WILTING POINT       = 0.1160 VOL/VOL
INITIAL SOIL WATER  = 0.1977 VOL/VOL
EFFECTIVE SAT. HYD. COND. = 0.369999994000E-03 CM/SEC
NOTE: SATURATED HYDRAULIC CONDUCTIVITY IS MULTIPLIED BY 3.00
      FOR ROOT CHANNELS IN TOP HALF OF EVAPORATIVE ZONE.

```

LAYER 2  
-----  
Page 1

MCDMTN18.txt

TYPE 1 - VERTICAL PERCOLATION LAYER

MATERIAL TEXTURE NUMBER 12

THICKNESS = 12.00 INCHES  
POROSITY = 0.4710 VOL/VOL  
FIELD CAPACITY = 0.3420 VOL/VOL  
WILTING POINT = 0.2100 VOL/VOL  
INITIAL SOIL WATER CONTENT = 0.4385 VOL/VOL  
EFFECTIVE SAT. HYD. COND. = 0.419999997000E-04 CM/SEC

LAYER 3

-----

TYPE 2 - LATERAL DRAINAGE LAYER

MATERIAL TEXTURE NUMBER 0

THICKNESS = 0.20 INCHES  
POROSITY = 0.8500 VOL/VOL  
FIELD CAPACITY = 0.0100 VOL/VOL  
WILTING POINT = 0.0050 VOL/VOL  
INITIAL SOIL WATER CONTENT = 0.8500 VOL/VOL  
EFFECTIVE SAT. HYD. COND. = 1.04999995000 CM/SEC  
SLOPE = 3.00 PERCENT  
DRAINAGE LENGTH = 275.0 FEET

LAYER 4

-----

TYPE 4 - FLEXIBLE MEMBRANE LINER

MATERIAL TEXTURE NUMBER 36

THICKNESS = 0.04 INCHES  
POROSITY = 0.0000 VOL/VOL  
FIELD CAPACITY = 0.0000 VOL/VOL  
WILTING POINT = 0.0000 VOL/VOL  
INITIAL SOIL WATER CONTENT = 0.0000 VOL/VOL  
EFFECTIVE SAT. HYD. COND. = 0.399999993000E-12 CM/SEC  
FML PINHOLE DENSITY = 1.00 HOLES/ACRE  
FML INSTALLATION DEFECTS = 1.00 HOLES/ACRE  
FML PLACEMENT QUALITY = 3 - GOOD

LAYER 5

-----

TYPE 3 - BARRIER SOIL LINER

MATERIAL TEXTURE NUMBER 6

THICKNESS = 12.00 INCHES  
POROSITY = 0.4530 VOL/VOL  
FIELD CAPACITY = 0.1900 VOL/VOL  
WILTING POINT = 0.0850 VOL/VOL  
INITIAL SOIL WATER CONTENT = 0.4530 VOL/VOL  
EFFECTIVE SAT. HYD. COND. = 0.720000011000E-03 CM/SEC



MCDMTN18.txt  
LAYER 6  
-----

TYPE 1 - VERTICAL PERCOLATION LAYER  
MATERIAL TEXTURE NUMBER 6  
THICKNESS = 948.00 INCHES  
POROSITY = 0.4530 VOL/VOL  
FIELD CAPACITY = 0.1900 VOL/VOL  
WILTING POINT = 0.0850 VOL/VOL  
INITIAL SOIL WATER CONTENT = 0.1902 VOL/VOL  
EFFECTIVE SAT. HYD. COND. = 0.720000011000E-03 CM/SEC

GENERAL DESIGN AND EVAPORATIVE ZONE DATA  
-----

NOTE: SCS RUNOFF CURVE NUMBER WAS USER-SPECIFIED.

SCS RUNOFF CURVE NUMBER = 61.00  
FRACTION OF AREA ALLOWING RUNOFF = 100.0 PERCENT  
AREA PROJECTED ON HORIZONTAL PLANE = 1.000 ACRES  
EVAPORATIVE ZONE DEPTH = 10.0 INCHES  
INITIAL WATER IN EVAPORATIVE ZONE = 2.681 INCHES  
UPPER LIMIT OF EVAPORATIVE STORAGE = 4.662 INCHES  
LOWER LIMIT OF EVAPORATIVE STORAGE = 1.536 INCHES  
INITIAL SNOW WATER = 0.000 INCHES  
INITIAL WATER IN LAYER MATERIALS = 192.383 INCHES  
TOTAL INITIAL WATER = 192.383 INCHES  
TOTAL SUBSURFACE INFLOW = 0.00 INCHES/YEAR

EVAPOTRANSPIRATION AND WEATHER DATA  
-----

NOTE: EVAPOTRANSPIRATION DATA WAS OBTAINED FROM  
ATLANTA GEORGIA

STATION LATITUDE = 33.65 DEGREES  
MAXIMUM LEAF AREA INDEX = 2.00  
START OF GROWING SEASON (JULIAN DATE) = 77  
END OF GROWING SEASON (JULIAN DATE) = 316  
EVAPORATIVE ZONE DEPTH = 10.0 INCHES  
AVERAGE ANNUAL WIND SPEED = 9.10 MPH  
AVERAGE 1ST QUARTER RELATIVE HUMIDITY = 65.00 %  
AVERAGE 2ND QUARTER RELATIVE HUMIDITY = 67.00 %  
AVERAGE 3RD QUARTER RELATIVE HUMIDITY = 76.00 %  
AVERAGE 4TH QUARTER RELATIVE HUMIDITY = 69.00 %

NOTE: PRECIPITATION DATA WAS SYNTHETICALLY GENERATED USING  
COEFFICIENTS FOR ATLANTA GEORGIA

NORMAL MEAN MONTHLY PRECIPITATION (INCHES)

JAN/JUL	FEB/AUG	MAR/SEP	APR/OCT	MAY/NOV	JUN/DEC
4.91	4.43	5.91	4.43	4.02	3.41

MCDMTN18. txt

	INCHES	CU. FEET	PERCENT
PRECIPITATION	44.09	160046.703	100.00
RUNOFF	0.000	0.000	0.00
EVAPOTRANSPIRATION	30.436	110482.867	69.03
DRAINAGE COLLECTED FROM LAYER 3	14.3803	52200.496	32.62
PERC./LEAKAGE THROUGH LAYER 5	0.353109	1281.784	0.80
AVG. HEAD ON TOP OF LAYER 4	1.6781		
PERC./LEAKAGE THROUGH LAYER 6	0.408814	1483.997	0.93
CHANGE IN WATER STORAGE	-1.135	-4120.639	-2.57
SOIL WATER AT START OF YEAR	192.177	697602.625	
SOIL WATER AT END OF YEAR	191.042	693482.000	
SNOW WATER AT START OF YEAR	0.000	0.000	0.00
SNOW WATER AT END OF YEAR	0.000	0.000	0.00
ANNUAL WATER BUDGET BALANCE	0.0000	-0.024	0.00

\*\*\*\*\*

\*\*\*\*\*

AVERAGE MONTHLY VALUES IN INCHES FOR YEARS 1 THROUGH 30

	JAN/JUL	FEB/AUG	MAR/SEP	APR/OCT	MAY/NOV	JUN/DEC
PRECIPITATION						
TOTALS	3.99 4.96	4.61 3.26	5.67 3.78	4.85 2.27	3.91 3.25	3.79 4.24
STD. DEVIATIONS	2.19 2.13	2.21 1.71	2.45 2.38	2.59 1.38	1.61 1.73	1.63 2.34
RUNOFF						
TOTALS	0.337 0.018	0.426 0.000	0.376 0.094	0.095 0.047	0.057 0.025	0.000 0.310
STD. DEVIATIONS	0.725 0.100	1.161 0.000	0.852 0.356	0.267 0.236	0.232 0.081	0.000 0.926
EVAPOTRANSPIRATION						
TOTALS	1.805 4.096	2.056 3.092	3.324 2.592	3.513 1.629	3.400 1.452	3.376 1.500

MCDMTN18. txt

STD. DEVIATIONS	0.240 1.250	0.382 1.241	0.491 1.278	1.006 0.455	0.878 0.276	1.421 0.210
LATERAL DRAINAGE COLLECTED FROM LAYER 3						
TOTALS	2.1867 0.5719	1.7739 0.2762	2.4443 0.7356	1.4374 0.7892	1.1196 1.0003	0.3532 1.9046
STD. DEVIATIONS	1.2436 0.7915	1.0482 0.4120	1.1582 0.9046	0.9844 0.9244	1.0765 1.0292	0.5011 1.4123
PERCOLATION/LEAKAGE THROUGH LAYER 5						
TOTALS	0.0730 0.0102	0.0561 0.0022	0.0852 0.0156	0.0365 0.0165	0.0282 0.0274	0.0031 0.0705
STD. DEVIATIONS	0.0840 0.0247	0.0566 0.0069	0.0757 0.0320	0.0429 0.0394	0.0406 0.0460	0.0126 0.0816
PERCOLATION/LEAKAGE THROUGH LAYER 6						
TOTALS	0.0342 0.0486	0.0247 0.0447	0.0366 0.0329	0.0286 0.0289	0.0449 0.0296	0.0492 0.0286
STD. DEVIATIONS	0.0389 0.0376	0.0253 0.0419	0.0291 0.0451	0.0239 0.0387	0.0313 0.0404	0.0303 0.0332

-----  
 AVERAGES OF MONTHLY AVERAGED DAILY HEADS (INCHES)  
 -----

DAILY AVERAGE HEAD ON TOP OF LAYER 4						
AVERAGES	4.1240 0.5631	3.4706 0.1184	4.8135 0.8975	2.1154 0.9192	1.5814 1.5931	0.1732 3.9902
STD. DEVIATIONS	4.7968 1.3880	3.5126 0.3826	4.3205 1.8750	2.5193 2.2362	2.2937 2.7011	0.7319 4.6477

\*\*\*\*\*

\*\*\*\*\*

AVERAGE ANNUAL TOTALS & (STD. DEVIATIONS) FOR YEARS 1 THROUGH 30

	INCHES		CU. FEET	PERCENT
PRECIPITATION	48.60	( 6.647)	176413.1	100.00
RUNOFF	1.784	( 1.9302)	6476.96	3.671
EVAPOTRANSPIRATION	31.835	( 2.9511)	115559.42	65.505
LATERAL DRAINAGE COLLECTED FROM LAYER 3	14.59292	( 3.47176)	52972.297	30.02741
PERCOLATION/LEAKAGE THROUGH LAYER 5	0.42464	( 0.19292)	1541.441	0.87377

MCDMTN18. txt

AVERAGE HEAD ON TOP OF LAYER 4	2.030 ( 0.938)		
PERCOLATION/LEAKAGE THROUGH LAYER 6	0.43162 ( 0.16306)	1566.789	0.88814
CHANGE IN WATER STORAGE	-0.045 ( 1.4563)	-162.32	-0.092

\*\*\*\*\*

\*\*\*\*\*

PEAK DAILY VALUES FOR YEARS	1 THROUGH	30
	(INCHES)	(CU. FT.)
PRECIPITATION	4.71	17097.301
RUNOFF	2.151	7806.7280
DRAINAGE COLLECTED FROM LAYER 3	0.13372	485.42148
PERCOLATION/LEAKAGE THROUGH LAYER 5	0.010297	37.37726
AVERAGE HEAD ON TOP OF LAYER 4	18.200	
MAXIMUM HEAD ON TOP OF LAYER 4	24.992	
LOCATION OF MAXIMUM HEAD IN LAYER 3 (DISTANCE FROM DRAIN)	86.0 FEET	
PERCOLATION/LEAKAGE THROUGH LAYER 6	0.006188	22.46172
SNOW WATER	5.40	19602.5937
MAXIMUM VEG. SOIL WATER (VOL/VOL)		0.4662
MINIMUM VEG. SOIL WATER (VOL/VOL)		0.1536

\*\*\* Maximum heads are computed using McEnroe's equations. \*\*\*

Reference: Maximum Saturated Depth over Landfill Liner  
 by Bruce M. McEnroe, University of Kansas  
 ASCE Journal of Environmental Engineering  
 Vol. 119, No. 2, March 1993, pp. 262-270.

\*\*\*\*\*

\*\*\*\*\*

FINAL WATER STORAGE AT END OF YEAR 30

LAYER	MCDMTN18. txt (INCHES)	(VOL/VOL)
1	1.1427	0.1905
2	4.2937	0.3578
3	0.0500	0.2500
4	0.0000	0.0000
5	5.4360	0.4530
6	180.1195	0.1900
SNOW WATER	0.000	

\*\*\*\*\*  
\*\*\*\*\*



MDCCCR3.txt

TYPE 3 - BARRIER SOIL LINER

MATERIAL TEXTURE NUMBER 0

THICKNESS	=	18.00	INCHES
POROSITY	=	0.4710	VOL/VOL
FIELD CAPACITY	=	0.3420	VOL/VOL
WILTING POINT	=	0.2100	VOL/VOL
INITIAL SOIL WATER CONTENT	=	0.4710	VOL/VOL
EFFECTIVE SAT. HYD. COND.	=	0.999999975000E-05	CM/SEC

LAYER 3

-----

TYPE 1 - VERTICAL PERCOLATION LAYER

MATERIAL TEXTURE NUMBER 6

THICKNESS	=	948.00	INCHES
POROSITY	=	0.4530	VOL/VOL
FIELD CAPACITY	=	0.1900	VOL/VOL
WILTING POINT	=	0.0850	VOL/VOL
INITIAL SOIL WATER CONTENT	=	0.2088	VOL/VOL
EFFECTIVE SAT. HYD. COND.	=	0.720000011000E-03	CM/SEC

GENERAL DESIGN AND EVAPORATIVE ZONE DATA

-----

NOTE: SCS RUNOFF CURVE NUMBER WAS USER-SPECIFIED.

SCS RUNOFF CURVE NUMBER	=	61.00	
FRACTION OF AREA ALLOWING RUNOFF	=	100.0	PERCENT
AREA PROJECTED ON HORIZONTAL PLANE	=	1.000	ACRES
EVAPORATIVE ZONE DEPTH	=	6.0	INCHES
INITIAL WATER IN EVAPORATIVE ZONE	=	1.094	INCHES
UPPER LIMIT OF EVAPORATIVE STORAGE	=	2.778	INCHES
LOWER LIMIT OF EVAPORATIVE STORAGE	=	0.696	INCHES
INITIAL SNOW WATER	=	0.000	INCHES
INITIAL WATER IN LAYER MATERIALS	=	207.521	INCHES
TOTAL INITIAL WATER	=	207.521	INCHES
TOTAL SUBSURFACE INFLOW	=	0.00	INCHES/YEAR

EVAPOTRANSPIRATION AND WEATHER DATA

-----

NOTE: EVAPOTRANSPIRATION DATA WAS OBTAINED FROM  
ATLANTA GEORGIA

STATION LATITUDE	=	33.65	DEGREES
MAXIMUM LEAF AREA INDEX	=	2.00	
START OF GROWING SEASON (JULIAN DATE)	=	77	
END OF GROWING SEASON (JULIAN DATE)	=	316	
EVAPORATIVE ZONE DEPTH	=	6.0	INCHES
AVERAGE ANNUAL WIND SPEED	=	9.10	MPH
AVERAGE 1ST QUARTER RELATIVE HUMIDITY	=	65.00	%
AVERAGE 2ND QUARTER RELATIVE HUMIDITY	=	67.00	%

MCDCCR3.txt

AVERAGE 3RD QUARTER RELATIVE HUMIDITY = 76.00 %  
 AVERAGE 4TH QUARTER RELATIVE HUMIDITY = 69.00 %

NOTE: PRECIPITATION DATA WAS SYNTHETICALLY GENERATED USING  
 COEFFICIENTS FOR ATLANTA GEORGIA

NORMAL MEAN MONTHLY PRECIPITATION (INCHES)

JAN/JUL	FEB/AUG	MAR/SEP	APR/OCT	MAY/NOV	JUN/DEC
4.91	4.43	5.91	4.43	4.02	3.41
4.73	3.41	3.17	2.53	3.43	4.23

NOTE: TEMPERATURE DATA WAS SYNTHETICALLY GENERATED USING  
 COEFFICIENTS FOR ATLANTA GEORGIA

NORMAL MEAN MONTHLY TEMPERATURE (DEGREES FAHRENHEIT)

JAN/JUL	FEB/AUG	MAR/SEP	APR/OCT	MAY/NOV	JUN/DEC
41.90	44.90	52.50	61.80	69.30	75.80
78.60	78.20	73.00	62.20	52.00	44.50

NOTE: SOLAR RADIATION DATA WAS SYNTHETICALLY GENERATED USING  
 COEFFICIENTS FOR ATLANTA GEORGIA  
 AND STATION LATITUDE = 33.65 DEGREES

- HEAD #1: AVERAGE HEAD ON TOP OF LAYER 2
- DRAIN #1: LATERAL DRAINAGE FROM LAYER 1 (RECIRCULATION AND COLLECTION)
- LEAK #1: PERCOLATION OR LEAKAGE THROUGH LAYER 2
- LEAK #2: PERCOLATION OR LEAKAGE THROUGH LAYER 3

\*\*\*\*\*  
 \*\*\*\*\*

DAILY OUTPUT FOR YEAR 1

DAY	A	S	RAIN	RUNOFF	ET	E. ZONE	HEAD	DRAIN	LEAK	HEAD
DRAIN	I	O	IN.	IN.	IN.	IN. /IN.	IN.	IN.	IN.	IN.
#2	I	LEAK				WATER	#1	#1	#1	#2
IN.	R	#2								
	L	IN.								
	IN.									

1 0.00 0.000 0.057 0.1729 0.0000 .0000E+00 .0000E+00 0.0000



	MCDCCR3.txt		
PERC. /LEAKAGE THROUGH LAYER 2	16.097435	58433.687	36.51
AVG. HEAD ON TOP OF LAYER 2	0.2481		
PERC. /LEAKAGE THROUGH LAYER 3	17.811485	64655.691	40.40
CHANGE IN WATER STORAGE	-1.907	-6923.842	-4.33
SOIL WATER AT START OF YEAR	246.118	893410.125	
SOIL WATER AT END OF YEAR	244.211	886486.312	
SNOW WATER AT START OF YEAR	0.000	0.000	0.00
SNOW WATER AT END OF YEAR	0.000	0.000	0.00
ANNUAL WATER BUDGET BALANCE	0.0000	0.055	0.00

\*\*\*\*\*

\*\*\*\*\*

AVERAGE MONTHLY VALUES IN INCHES FOR YEARS 1 THROUGH 30

	JAN/JUL	FEB/AUG	MAR/SEP	APR/OCT	MAY/NOV	JUN/DEC
<b>PRECIPITATION</b>						
TOTALS	3.99 4.96	4.61 3.26	5.67 3.78	4.85 2.27	3.91 3.25	3.79 4.24
STD. DEVIATIONS	2.19 2.13	2.21 1.71	2.45 2.38	2.59 1.38	1.61 1.73	1.63 2.34
<b>RUNOFF</b>						
TOTALS	0.340 0.109	0.450 0.000	0.497 0.196	0.348 0.059	0.189 0.193	0.000 0.293
STD. DEVIATIONS	0.738 0.327	0.921 0.000	0.926 0.558	0.675 0.219	0.381 0.408	0.000 0.827
<b>EVAPOTRANSPIRATION</b>						
TOTALS	1.655 3.624	1.851 2.600	2.761 2.256	2.849 1.393	2.612 1.430	2.943 1.467
STD. DEVIATIONS	0.291 1.036	0.466 0.976	0.632 1.147	0.906 0.493	0.776 0.291	1.225 0.259
<b>PERCOLATION/LEAKAGE THROUGH LAYER 2</b>						
TOTALS	2.2258 1.1720	2.2432 0.6575	2.4603 1.3523	1.7338 0.8995	1.3416 1.3531	0.6587 2.3870
STD. DEVIATIONS	1.7759 1.1377	1.4823 0.7004	1.4541 1.1853	1.1805 1.0308	0.9374 1.2602	0.5109 1.8109

PERCOLATION/LEAKAGE THROUGH LAYER 3

TOTALS	1.1347	1.1664	1.1579	1.4544	1.6286	1.7181
	1.7196	1.6642	1.4776	1.4749	1.3994	1.2645
STD. DEVIATIONS	0.6071	0.5225	0.6145	0.7082	0.7281	0.7019
	0.6029	0.4726	0.4514	0.5870	0.4882	0.4660

AVERAGES OF MONTHLY AVERAGED DAILY HEADS (INCHES)

DAILY AVERAGE HEAD ON TOP OF LAYER 2

AVERAGES	0.3077	0.4521	0.4447	0.3005	0.2445	0.0789
	0.1929	0.0679	0.2467	0.1377	0.2528	0.3788
STD. DEVIATIONS	0.3048	0.4442	0.3369	0.2691	0.2674	0.0807
	0.2690	0.0964	0.2881	0.2370	0.3022	0.3916

\*\*\*\*\*

\*\*\*\*\*

AVERAGE ANNUAL TOTALS & (STD. DEVIATIONS) FOR YEARS 1 THROUGH 30

	INCHES		CU. FEET	PERCENT
PRECIPITATION	48.60	( 6.647)	176413.1	100.00
RUNOFF	2.675	( 2.1379)	9711.14	5.505
EVAPOTRANSPIRATION	27.440	( 2.7693)	99607.50	56.463
PERCOLATION/LEAKAGE THROUGH LAYER 2	18.48482	( 4.51527)	67099.891	38.03566
AVERAGE HEAD ON TOP OF LAYER 2	0.259	( 0.084)		
PERCOLATION/LEAKAGE THROUGH LAYER 3	17.26032	( 4.89562)	62654.957	35.51604
CHANGE IN WATER STORAGE	1.223	( 6.2957)	4439.57	2.517

\*\*\*\*\*

♀

\*\*\*\*\*

PEAK DAILY VALUES FOR YEARS 1 THROUGH 30

	(INCHES)	(CU. FT.)
PRECIPITATION	4.71	17097.301

MCDCCR3.txt

RUNOFF		3.422	12422.7168
PERCOLATION/LEAKAGE THROUGH LAYER	2	0.453537	1646.34021
AVERAGE HEAD ON TOP OF LAYER	2	6.000	
PERCOLATION/LEAKAGE THROUGH LAYER	3	0.218412	792.83582
SNOW WATER		5.40	19602.5937
MAXIMUM VEG. SOIL WATER (VOL/VOL)			0.4630
MINIMUM VEG. SOIL WATER (VOL/VOL)			0.1160

\*\*\*\*\*

♀  
†

\*\*\*\*\*


FINAL WATER STORAGE AT END OF YEAR 30

LAYER	(INCHES)	(VOL/VOL)
1	1.0498	0.1750
2	8.4780	0.4710
3	234.6834	0.2476
SNOW WATER	0.000	

\*\*\*\*\*  
\*\*\*\*\*

**APPENDIX H**

**Veneer Stability Analyses  
Calculation Package**

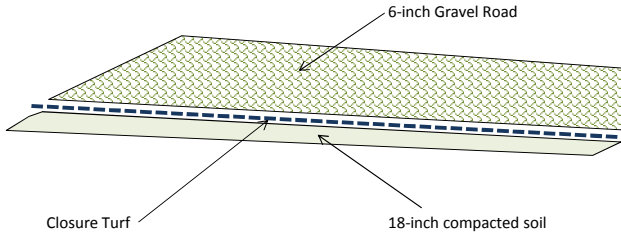
	<b>SUBJECT: Stability of Cover System - Veneer Stability</b>		
	<b>Job No.</b> 1777449	Prepared by DM	Date 7/19/2018
	<b>Ref. :</b> Plant McDonough-Atkinson Closed CCR Surface Impoundment Units AP-1 and AP-3/4	Checked by LJ / LS	
	Reviewed by GLH		

**OBJECTIVE:**

Analyze the stability of the cover system for the closed conditions of CCR surface impoundments AP-1 and AP-3/4. Use design strength parameters and analyze for conditions with and without seepage forces.

**GEOMETRY (Final Cover System):**

Slope is 6 H:1V Maximum Road Grade is 10%



**GOLDER RECOMMENDED FACTORS OF SAFETY FOR LANDFILL (CLOSED CCR SURFACE IMPOUNDMENT) FINAL COVER**

Shear Strength	Long Term (w/ Seepage)	Long Term <sup>b</sup>
Design	N/A <sup>a</sup>	1.5

<sup>a</sup> The gravel road is comprised of free draining No. 89 Stone.  
<sup>b</sup> Recommended factor of safety with and w/out vehicle loading

If the calculated factors of safety based on the final cover conditions are higher than the recommended factors of safety, the stability of the final cover meets the requirement.

Based on Proposed Final Grades (representative of AP-1 and AP-3/4 closed unit conditions):

Top Elevation of Final Grades: 896 ft  
 Approx. Internal Toe Elevation: 844 ft

\* These apply to the condition of roads placed on top of closure turf

**Material Properties (ref 4)**

Material	c (psf)	c <sub>a</sub> (psf)	φ (°)	δ (°)	γ (pcf)	Thickness (ft)
Gravel Road (GM) <sup>(1)</sup>	0	-	36	-	130	0.50
Closure Turf <sup>(2)</sup>	-	0	-	27	-	0.03

<sup>(1)</sup> Used gravel material properties based on past experience with similar type of material.

<sup>(2)</sup> Conservatively downgraded interface strength as 75% of gravel material properties.

Where:  
 c = Cohesion of the protective cover soil  
 c<sub>a</sub> = Adhesion between protective cover soil of the active wedge and the geomembrane  
 δ = Interface friction angle between cover soil and geomembrane  
 φ = Friction Angle of protective cover soil  
 γ = Unit weight of the protective cover soil

Slope Angle = β (°) = 10.0  
 Slope Height = 52 ft (H)

**CALCULATIONS:**

**LONG TERM VENEER STABILITY based on Koerner/Soong Method (page 487 to 490, ref. 1)**

Using the Koerner/Soong Method, the factor of safety is calculated using the following equation (Eq. 13.9, ref. 2)

$$FS = \frac{-b \pm (b^2 - 4 \times a \times c)^{0.5}}{2 \times a}$$

Where:

$$a = (W_a - N_a \times \cos \beta) \cos \beta$$

$$b = -(W_a - N_a \times \cos \beta) \times \sin \beta \tan \phi + (N_a \times \tan \delta + C_a) \times \sin \beta \times \cos \beta + (C + W_p \times \tan \phi) \times \sin \beta$$

$$c = (N_a \times \tan \delta + C_a) \times \sin^2 \beta \times \tan \phi$$

$$W_a = \gamma \times h^2 \times (L/h - 1/\sin \beta - \tan \beta / 2)$$

$$N_a = W_a \times \cos \beta$$


$$C_a = c_a \times (L - h/\sin \beta)$$

$$W_p = (\gamma \times h^2) / \sin 2\beta$$

$$C = c \times h / \sin \beta$$

Where:

W<sub>a</sub> = Total weight of the active wedge

	<b>SUBJECT: Stability of Cover System - Veneer Stability</b>		
	<b>Job No.</b> 1777449	Prepared by DM	Date 7/19/2018
	<b>Ref. :</b> Plant McDonough-Atkinson Closed CCR Surface Impoundment Units AP-1 and AP-3/4	Checked by LJ / LS	
	Reviewed by GLH		

$N_a$  = Effective force normal to the failure plane of the active wedge  
 $C_a$  = Adhesive force between protective cover soil of the active wedge and the geomembrane  
 $W_p$  = Total weight of the passive wedge  
 $C$  = Cohesive force along the failure plane of the passive wedge  
 $\gamma$  = Unit Weight of protective cover soil  
 $h$  = Thickness of protective cover soil  
 $\beta$  = Slope Angle  
 $L$  = Length of slope measured along the geosynthetic interface  
 $c$  = Cohesion of the protective cover soil  
 $c_a$  = Adhesion between protective cover soil of active wedge and geomembrane  
 $\delta$  = Interface friction angle between protective cover soil and geomembrane  
 $\phi$  = Friction Angle of protective cover soil

Where:  
 $h$  = Thickness of Prot. Cover (ft) = 0.50  
 $\beta$  = Cover Slope Angle (°) = 10.0  
 $H_{max}$  = Maximum height = 52.0 feet  
 $L$  = 300.9 feet

Since  $h$  and  $L$  are known for **LONG-TERM Conditions**, solve for the FS:

$W_a$ (lbs/ft) =	19,369	$W_p$ (lbs/ft) =	95
$N_a$ (lbs/ft) =	19,078	$C$ (lbs/ft) =	0
$C_a$ (lbs/ft) =	298 x $c_a$		
$(W_a - N_a \times \cos \beta)$ =	578		
$(C + W_p \times \tan \phi)$ =	69		
$\cos \beta$ =	0.98		
$\sin \beta$ =	0.17		
$\sin \beta \times \tan \phi$ =	0.13		
$\sin^2 \beta \times \tan \phi$ =	0.02		
$\sin \beta \times \cos \beta$ =	0.17		
$\tan \phi$ =	0.73		
$a$ =	569.7		

Solve for FS with different combinations of  $\delta$  and  $c_a$ :

$\delta$ (°)	$c_a$ (psf)	$\tan \delta$	$C_a$ (lbs/ft)	$(N_a \times \tan \delta + C_a)$	$b$	$c$	$(b^2 - 4ac)^{0.5}$	Factor of Safety
27.0	0	0.510	0	9,721	-1,739	211	1594.9	2.9

**VEHICLE LOADING ON ROAD CONDITIONS ( Dozer on the slope with acceleration)**

**Veneer Stability based on Koerner/Soong Method (page 490-497, ref. 1) for the case of vehicle loading acceleration**

$$FS = \frac{-b \pm (b^2 - 4 \times a \times c)^{0.5}}{2 \times a}$$

Where:

$a = (W_{a+e} \times \sin \beta + Fe) \cos \beta$   
 $b = - [(N_{a+e} \times \tan \delta + C_a) \times \cos \beta + (W_{a+e} \times \sin \beta + Fe) \times \sin \beta \times \tan \phi] + (C + W_p \times \tan \phi)$   
 $c = (N_{a+e} \times \tan \delta + C_a) \times \sin \beta \times \tan \phi$

$Fe = W_e \times (a/g)$  - Dynamic force per unit width parallel to the slope

$a$  = acceleration of the construction equipment

$g$  = acceleration due to gravity

$W_a = \gamma \times h^2 \times (L/h - 1/\sin \beta - \tan \beta / 2)$

$W_e$  = Equivalent Equipment Force per unit width at geomembrane interface

$W_{a+e} = W_a + W_e$

$N_{a+e} = W_{a+e} \times \cos \beta$


$C_a = c_a \times (L - h/\sin \beta)$

$W_p = (\gamma \times h^2) / \sin 2\beta$

$C = c \times h / \sin \beta$

The definitions of all the parameters are as same as those in long term FS calculation except  $W_e$ ,  $W_{a+e}$ , and  $N_{a+e}$

$L_{short\ term}$ =	300.9	ft
$h_{short\ term}$ =	0.50	ft
$\phi$ =	36.00	degrees
$c$ =	0.00	psf
$\gamma_{soil\ cover}$ =	130.00	pcf

	<b>SUBJECT: Stability of Cover System - Veneer Stability</b>		
	<b>Job No.</b> 1777449	Prepared by DM	Date 7/19/2018
	<b>Ref. :</b> Plant McDonough-Atkinson Closed CCR Surface Impoundment Units AP-1 and AP-3/4	Checked by LJ / LS	
	Reviewed by GLH		

Determination of  $W_e$  (See dozer specifications from manufacturer, ref. 2):

**Specifications for D6H LGP Series II Crawler Tractor**

Width of Dozer Track =	3.00 ft
Contact Area =	64.26 sq.ft.
Ground Pressure =	4.8 psi
Influence factor (I) =	1.00 (obtained from Figure 13.7, page 493, ref. 2)
Ground Pressure at Geosynthetics =	686.7 psf
Length of Dozer Track =	10.7 ft

$W_e = 7355$  lbs/ft

$W_a + W_e$  (lbs/ft) = 26,725

$N_{a+e}$  (lbs/ft) = 26,322

$C_a$  (lbs/ft) =  $298 \times c_a$

$W_p$  (lbs/ft) = 95

$C$  (lbs/ft) = 0

$(W_{a+e} - N_{a+e} \times \cos \beta) = 798$

$(C + W_p \times \tan \phi) = 69$

$\cos \beta = 0.98$

$\sin \beta = 0.17$

$\sin \beta \times \tan \phi = 0.13$

$\sin^2 \beta \times \tan \phi = 0.02$

$\sin \beta \times \cos \beta = 0.17$

$\tan \phi = 0.73$

$(W_{a+e} \times \sin \beta + Fe) = 6,825$

$(C + W_p \times \tan \phi) = 0$

$\cos \beta = 0.98$

$\sin \beta = 0.17$

$\sin \beta \times \tan \phi = 0.13$

$\sin^2 \beta \times \tan \phi = 0.02$

$\sin \beta \times \cos \beta = 0.17$

$\tan \phi = 0.73$

$a = 0.30$  g (from Figure 13.9)

$Fe = 2206.55$  lbs/ft

$a = 6721.9$

Solve for FS :

$\delta$ (°)	$c_a$ (psf)	$\tan \delta$	$C_a$ (lbs/ft)	$(N_{a+e} \times \tan \delta + C_a)$	b	c	$(b^2 - 4ac)^{0.5}$	Factor of Safety
27.0	0	0.510	0.00	13,412	-14,067	291	13,786	2.1

**SUMMARY OF RESULTS**

CASE ANALYZED	REQUIRED FACTOR OF SAFETY	ACTUAL FACTOR OF SAFETY	MEET REQUIREMENT
Long Term using Design Shear Strength	1.5	2.9	Yes
Long Term using Design Shear Strength - Dozer on Road w/ acceleration	1.5	2.1	Yes

The stability of the final cover system meets the recommended factors of safety. These results are based on strength parameters for the soils encountered on site during Golder's geotechnical investigation.

**References:**

1. Qian, X., Koerner, R. M., Gray, D. H., Geotechnical Aspects of Landfill Design and Construction, Prentice Hall, New Jersey, US, 2002.
2. Dozer Specifications from Manufacturer
3. Golder Associates Inc., Unpublished Database of Direct Shear Laboratory Results.

# ATTACHMENT A

## VENEER STABILITY REFERENCE INFORMATION



13.4 VENEER SLOPE STABILITY ANALYSES

This section treats the standard veneer slope stability problem [as shown in Figure 13.1(a) and (b)] and then superimposes upon it a number of situations, all which tend to destabilize slopes. Included are gravitational, construction equipment, seepage and seismic forces, respectively. Each will be illustrated by a design graph and a numeric example.

13.4.1 Cover Soil (Gravitational) Forces

Figure 13.3 illustrates the common situation of a finite-length, uniformly-thick cover soil placed over a liner material at a slope angle  $\beta$ . It includes a passive wedge at the toe and has a tension crack on the crest. The analysis that follows is from Koerner and Soong (1998), but it is similar to Koerner and Hwu (1991). Comparable analyses are also available from Giroud and Beech (1989), McKelvey and Deutsch (1991), and others.

The symbols used in Figure 13.3 are defined as follows:

- $W_A$  = total weight of the active wedge
- $W_P$  = total weight of the passive wedge
- $N_A$  = effective force normal to the failure plane of the active wedge
- $N_P$  = effective force normal to the failure plane of the passive wedge
- $\gamma$  = unit weight of the cover soil
- $h$  = thickness of the cover soil
- $L$  = length of slope measured along the geomembrane
- $\beta$  = soil slope angle beneath the geomembrane

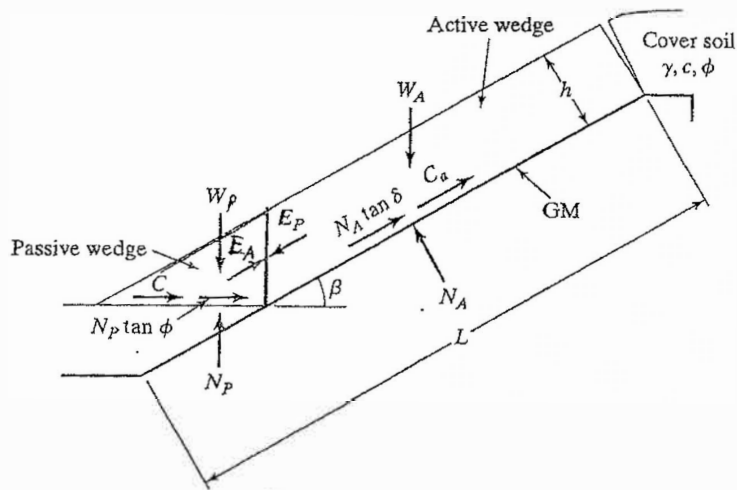


FIGURE 13.3 Limit Equilibrium Forces Involved in a Finite Length Slope Analysis for a Uniformly Thick Cover Soil

- $\phi$  = friction angle of the cover soil  
 $\delta$  = interface friction angle between cover soil and geomembrane  
 $C_a$  = adhesive force between cover soil of the active wedge and the geomembrane  
 $c_a$  = adhesion between cover soil of the active wedge and the geomembrane  
 $C$  = cohesive force along the failure plane of the passive wedge  
 $c$  = cohesion of the cover soil  
 $E_A$  = interwedge force acting on the active wedge from the passive wedge  
 $E_P$  = interwedge force acting on the passive wedge from the active wedge  
 $FS$  = factor of safety against cover soil sliding on the geomembrane.

The expression for determining the factor of safety can be derived as follows:

Considering the active wedge, the forces acting on it are

$$W_A = \gamma \cdot h^2 \cdot (L/h - 1/\sin\beta - \tan\beta/2) \quad (13.4)$$

$$N_A = W_A \cdot \cos\beta \quad (13.5)$$

$$C_a = c_a \cdot (L - h/\sin\beta) \quad (13.6)$$

By balancing the forces in the vertical direction, the following formulation results:

$$E_A \cdot \sin\beta = (W_A - N_A \cdot \cos\beta) - \frac{(N_A \cdot \tan\delta + C_a) \cdot \sin\beta}{FS}$$

Hence, the interwedge force acting on the active wedge is

$$E_A = \frac{(FS)(W_A - N_A \cdot \cos\beta) - (N_A \cdot \tan\delta + C_a) \cdot \sin\beta}{\sin\beta \cdot (FS)} \quad (13.7)$$

The passive wedge can be considered in a similar manner:

$$W_P = \frac{\gamma \cdot h^2}{\sin 2\beta}$$

$$N_P = W_P + E_P \cdot \sin\beta$$

$$C = \frac{c \cdot h}{\sin\beta} \quad (13.8)$$

By balancing the forces in the horizontal direction, the following formulation results:

$$E_P \cdot \cos\beta = \frac{C + N_P \cdot \tan\phi}{FS}$$

Hence, the interwedge force acting on the passive wedge is

$$E_P = \frac{C + W_P \cdot \tan\phi}{\cos\beta \cdot (FS) - \sin\beta \cdot \tan\phi}$$

By setting  $E_A = E_P$ , the resulting equation can be arranged in the form of the quadratic equation  $ax^2 + bx + c = 0$ , which in this case, using  $FS$ -values, results in

$$a \cdot FS^2 + b \cdot FS + c = 0$$

The resulting  $FS$ -value is then obtained from the conventional solution of the quadratic equation, which gives

$$FS = \frac{-b \pm (b^2 - 4 \cdot a \cdot c)^{0.5}}{2 \cdot a} \tag{13.9}$$

where

$$a = (W_A - N_A \cdot \cos \beta) \cdot \cos \beta$$

$$b = -[(W_A - N_A \cdot \cos \beta) \cdot \sin \beta \cdot \tan \phi + (N_A \cdot \tan \delta + C_a) \cdot \sin \beta \cdot \cos \beta + (C + W_P \cdot \tan \phi) \cdot \sin \beta]$$

$$c = (N_A \cdot \tan \delta + C_a) \cdot \sin^2 \beta \cdot \tan \phi$$

When the calculated  $FS$ -value falls below 1.0, sliding of the cover soil on the geomembrane is to be anticipated. Thus, a value of greater than 1.0 must be targeted as being the minimum factor of safety. How much greater than 1.0 the  $FS$ -value should be, is a design and/or regulatory issue. Recommendations for minimum allowable  $FS$ -values under different conditions are available in Koerner and Soong (1998). In order to better illustrate the implications of Equations 13.9, typical design curves for various  $FS$ -values as a function of slope angle and interface friction angle are given in Figure 13.4. Note that the curves are developed specifically for the variables stated in the legend of the figure. Example 13.1 illustrates the use of the analytic development and the

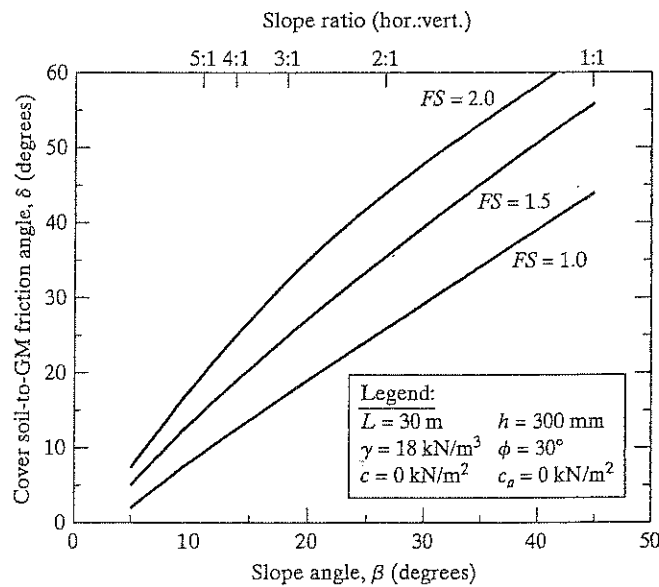


FIGURE 13.4 Design Curves for Stability of Uniform-Thickness Cohesionless Cover Soils on Linear Failure Planes for Various Global Factors of Safety

will be considered as compared.

### EXAMPLE 13.1

The following are given: a 30-m slope with a uniformly thick 300-mm-deep cover soil at a unit weight of  $18 \text{ kN/m}^3$ . The soil has a friction angle of  $30^\circ$  and zero cohesion (i.e., it is a sand). The cover soil is placed directly on a geomembrane as shown in Figure 13.3. Direct shear testing has resulted in an interface friction angle between the cover soil and geomembrane of  $22^\circ$  with zero adhesion. What is the  $FS$ -value at a slope angle of 3(H)-to-1(V) (i.e.,  $18.4^\circ$ )?

**Solution** Using Equation 13.9 to solve for the  $FS$ -value results in a value of 1.25, which is seen to be in agreement with the curves of Figure 13.4:

$$a = 14.7 \text{ kN/m}$$

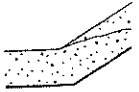
$$b = -21.3 \text{ kN/m}$$

$$c = 3.5 \text{ kN/m}$$

Thus,  $FS = 1.25$

This value can be confirmed using Figure 13.4.

**Comment** In general, this is too low of a value for a final cover soil factor-of-safety and a redesign is necessary. There are many possible options to increase the value (e.g., changing the geometry of the situation, the use of toe berms, tapered cover soil thickness, and veneer reinforcement, see Koerner and Soong, 1998). Nevertheless, this general problem will be used throughout this section for comparison with other cover soil slope stability situations.



### 13.4.2 Tracked Construction Equipment Forces

The placement of cover soil on a slope with a relatively low shear strength interface (like a geomembrane) should always start at the toe and move upward to the crest. Figure 13.5(a) shows the recommended method. In doing so, the gravitational forces of the cover soil and live load of the construction equipment are compacting previously placed soil and working with an ever-present passive wedge and a stable lower portion beneath the active wedge. While it is necessary to specify low ground pressure equipment to place the soil, the reduction in the  $FS$ -value for this situation of equipment working up the slope will be seen to be relatively small.

For soil placement down the slope, however, a stability analysis cannot rely on toe buttressing and also a dynamic stress should be included in the calculation. These conditions decrease the  $FS$ -value—in some cases, to a great extent. Figure 13.5(b) shows this procedure. Unless absolutely necessary, it is not recommended that cover soil be placed on a slope in this manner. If it is necessary, the design must consider the unsupported soil mass and the possible dynamic force of the specific type of construction equipment and its manner of operation.

For the *first case* of a bulldozer pushing cover soil up from the toe of the slope to the crest, the analysis uses the free body diagram of Figure 13.6(a). The analysis uses a

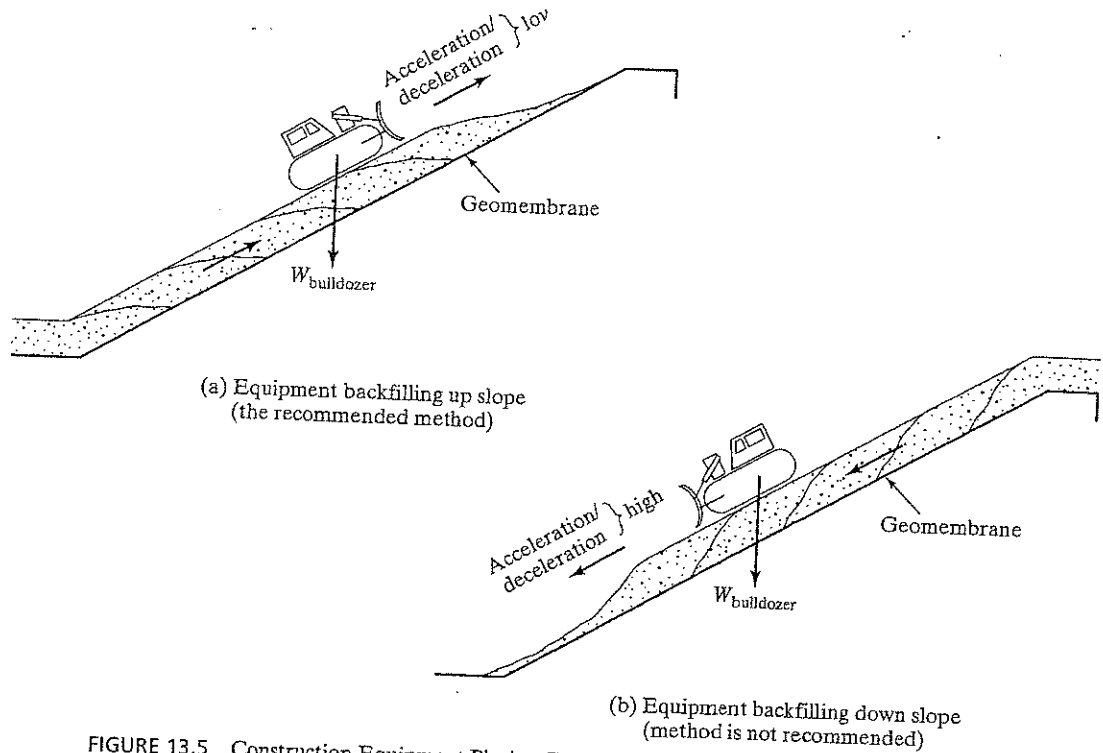


FIGURE 13.5 Construction Equipment Placing Cover Soil on Slopes Containing Geosynthetics

known type of construction equipment (such as a bulldozer characterized by its ground contact pressure) and dissipates this force or stress through the cover soil thickness to the surface of the geomembrane. A Boussinesq analysis is used (see Poulos and Davis, 1974). This results in an equipment force per unit width of

$$W_e = q \cdot w \cdot I \quad (13.10)$$

where  $W_e$  = equivalent equipment force per unit width at the geomembrane interface;

$$q = W_b / (2 \cdot w \cdot b);$$

$W_b$  = actual weight of equipment (e.g., a bulldozer);

$w$  = length of equipment track;

$b$  = width of equipment track;

$I$  = influence factor at the geomembrane interface (see Figure 13.7).

Upon determining the additional equipment force at the cover soil-to-geomembrane interface, the analysis proceeds as described in Section 13.3.1 for gravitational forces only. In essence, the equipment moving up the slope adds an additional term ( $W_e$ ) to the  $W_A$ -force in Equation 13.4. Note, however, that this involves the generation of a resisting force as well. Thus the net effect of increasing the driving force is

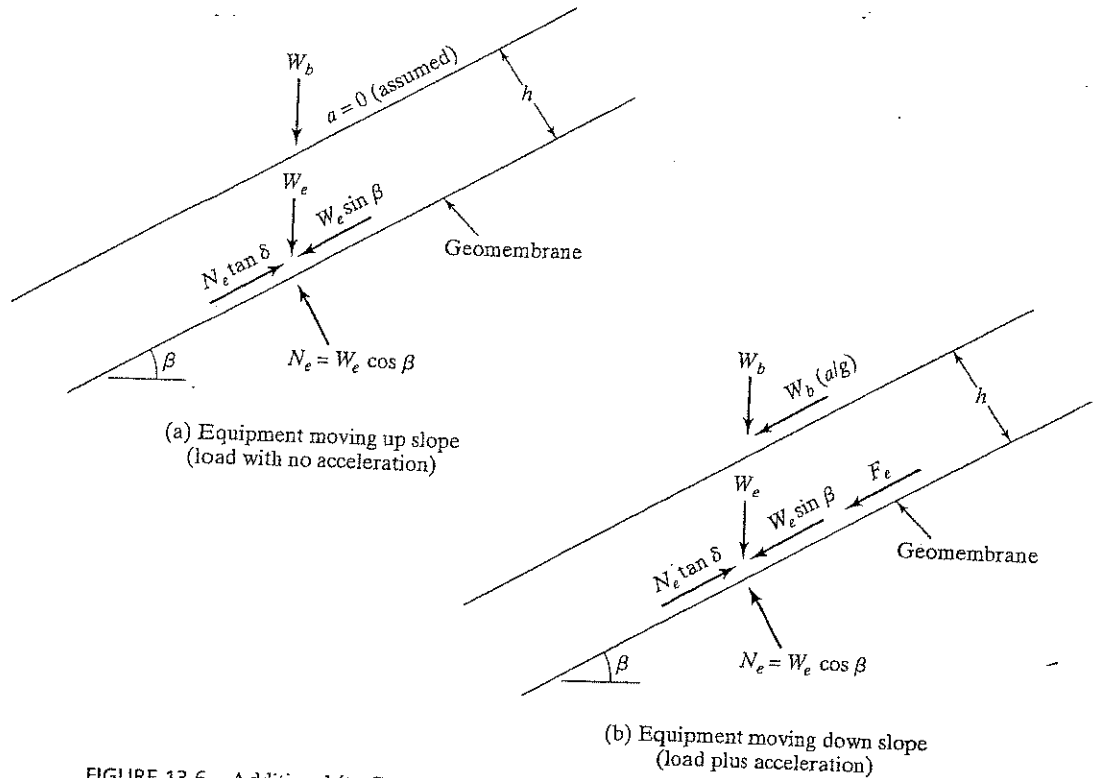


FIGURE 13.6 Additional (to Gravitational Forces) Limit Equilibrium Forces due to Construction Equipment Moving on Cover Soil (see Figure 13.3 for the gravitational soil force to which the above forces are added).

concerned. It should also be noted that no acceleration/deceleration forces are included in this analysis, which is somewhat idealistic. Using these concepts (the same equations used in Section 13.3.1 are used here), typical design curves for various *FS*-values as a function of equivalent ground contact equipment pressures and cover soil thicknesses are given in Figure 13.8. Note that the curves are developed specifically for the variables stated in the legend. Example 13.2 illustrates the use of the formulation.

**EXAMPLE 13.2**

The following are given: a 30-m-long slope with uniform cover soil of 300 mm thickness at a unit weight of 18 kN/m<sup>3</sup>. The soil has a friction angle of 30° and zero cohesion (i.e., it is a sand). It is placed on the slope using a bulldozer moving from the toe of the slope up to the crest. The bulldozer has a ground pressure of 30 kN/m<sup>2</sup> and tracks that are 3.0 m long and 0.6 m wide. The cover soil to geomembrane friction angle is 22° with zero adhesion. What is the *FS*-value at a slope angle 3(H)-to-1(V) (i.e., 18.4°)?

**Solution** This problem follows Example 13.1 exactly except for the addition of the bulldozer moving up the slope. Using the additional equipment load, Equation 13.10 substituted into Equation 13.9 results in the following:

$$a = 73.1 \text{ kN/m}$$

$$b = -104.3 \text{ kN/m}$$

$$c = 17.0 \text{ kN/m}$$

Thus,  $FS = 1.24$

This value can be confirmed using Figure 13.8.

**Comment** While the resulting  $FS$ -value is still low, the result is important to assess by comparing it with Example 13.1 (i.e., the same problem except without the bulldozer). It is seen that the  $FS$ -value has only decreased from 1.25 to 1.24. Thus, in general, a low ground contact pressure bulldozer placing cover soil up the slope with negligible acceleration/deceleration forces does not significantly decrease the factor-of-safety.

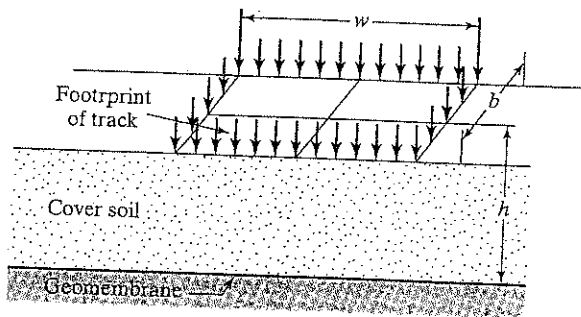
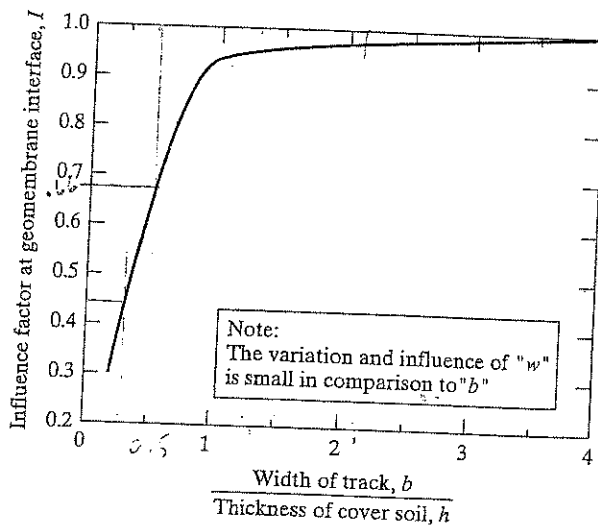


FIGURE 13.7 Values of Influence Factor, "I", for Use in Equation 13.10 to Dissipate Surface Force through the Cover Soil to the Geomembrane Interface (after Soong and Koerner, 1996)



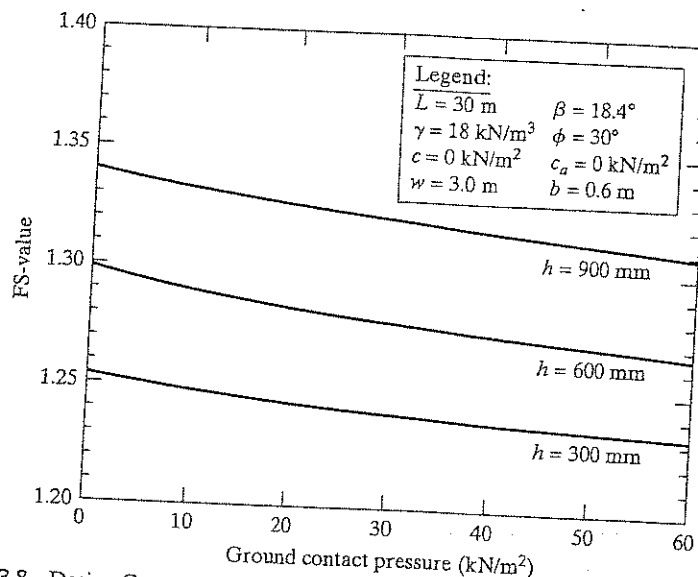


FIGURE 13.8 Design Curves for Stability of Different Thickness of Cover Soil for Various Construction Equipment Ground Contact Pressure

For the *second case* of a bulldozer pushing cover soil down from the crest of the slope to the toe as shown in Figure 13.5b, the analysis uses the force diagram of Figure 13.6(b). While the weight of the equipment is treated as just described, the lack of a passive wedge along with an additional force due to acceleration (or deceleration) of the equipment significantly decreases the resulting *FS*-values. This analysis again uses a specific piece of construction equipment operated in a specific manner. It produces a force parallel to the slope equivalent to  $W_b \cdot (a/g)$ , where  $W_b$  = the weight of the bulldozer,  $a$  = acceleration of the bulldozer, and  $g$  = acceleration due to gravity. Its magnitude is equipment operator dependent and related to both the equipment speed and time to reach such a speed (see Figure 13.9).

The acceleration of the bulldozer, coupled with an influence factor  $I$  from Figure 13.7, results in the dynamic force per unit width at the cover soil to geomembrane interface  $F_e$ . The relationship is given by

$$F_e = W_e \cdot (a/g) \tag{13.11}$$

- where
- $F_e$  = dynamic force per unit width parallel to the slope at the geomembrane interface;
  - $W_e$  = equivalent equipment (e.g., bulldozer) force per unit width at geomembrane interface, recall Equation 13.10;
  - $\beta$  = soil slope angle beneath geomembrane;
  - $a$  = acceleration of the construction equipment;
  - $g$  = acceleration due to gravity.

Using these concepts, the new force parallel to the cover soil surface is dissipated through the thickness of the cover soil to the interface of the geomembrane. Again, a



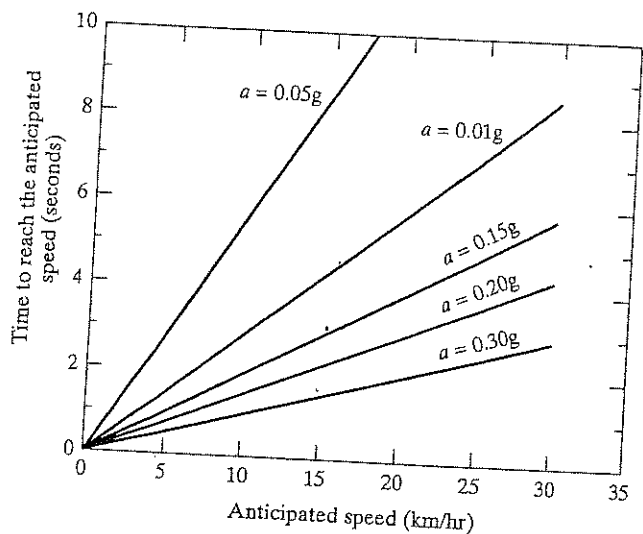


FIGURE 13.9 Graphic Relationship of Construction Equipment Speed and Rise Time to Obtain Equipment Acceleration.

Boussinesq analysis is used (see Poulos and Davis, 1974). The expression for determining the  $FS$ -value is derived next.

Considering the active wedge and balancing the forces in the direction parallel to the slope, the resulting formulation is

$$E_A + \frac{(N_e + N_A) \cdot \tan \delta + C_a}{FS} = (W_A + W_e) \cdot \sin \beta + F_e$$

where

$N_e$  = effective equipment force normal to the failure plane of the active wedge.

$$N_e = W_E \cdot \cos \beta \tag{13.12}$$

Note that all the other symbols have been previously defined.

The interwedge force acting on the active wedge can now be expressed as

$$E_A = \frac{(FS)[(W_A + W_e) \cdot \sin \beta + F_e]}{FS} - \frac{[(N_A + N_e) \cdot \tan \delta + C_a]}{FS}$$

The passive wedge can be treated in a similar manner. The following formulation of the interwedge force acting on the passive wedge results:

$$E_P = \frac{C + W_P \cdot \tan \phi}{\cos \beta \cdot (FS) - \sin \beta \cdot \tan \phi}$$

By setting  $E_A = E_P$ , the resulting equation can be arranged in the form of the quadratic equation  $ax^2 + bx + c = 0$  which in this case, using  $FS$ -values, is

$$a \cdot FS^2 + b \cdot FS + c = 0$$

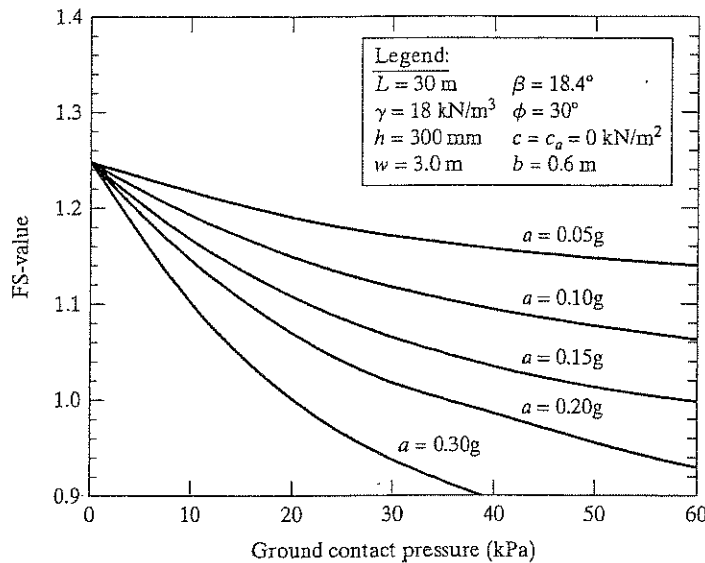


FIGURE 13.10 Design Curves for Stability of Different Construction Equipment Ground Contact Pressure for Various Equipment Accelerations

The resulting  $FS$ -value is then obtained from the conventional solution of the quadratic equation

$$FS = \frac{-b \pm (b^2 - 4 \cdot a \cdot c)^{0.5}}{2 \cdot a} \quad (13.13)$$

where

$$a = [(W_A + W_e) \cdot \sin \beta + F_e] \cdot \cos \beta$$

$$b = -\{[(N_A + N_e) \cdot \tan \delta + C_a] \cdot \cos \beta + [(W_A + W_e) \cdot \sin \beta + F_e] \cdot \sin \beta \cdot \tan \phi + (C + W_P \cdot \tan \phi)\}$$

$$c = [(N_A + N_e) \cdot \tan \delta + C_a] \cdot \sin \beta \cdot \tan \phi$$

Using these concepts, typical design curves for various  $FS$ -values as a function of equipment ground contact pressure and equipment acceleration can be developed (see Figure 13.10). Note that the curves are developed specifically for the variables stated in the legend. Example 13.3 illustrates the use of the formulation.

### EXAMPLE 13.3

The following are given: a 30-m-long slope with uniform cover soil of 300-mm thickness at a unit weight of  $18 \text{ kN/m}^3$ . The soil has a friction angle of  $30^\circ$  and zero cohesion (i.e., it is a sand). It is placed on the slope using a bulldozer moving from the crest of the slope down to the toe. The bulldozer has a ground contact pressure of  $30 \text{ kN/m}^2$  and tracks that are 3.0 m long and 0.6 m wide. The estimated equipment speed is 20 km/hr, and the time to reach this speed is 3.0 seconds. The cover soil to geomembrane friction angle is 22 degrees with zero adhesion. What is the  $FS$ -value at a slope angle of 3(H)-to-1(V) (i.e.,  $18.4^\circ$ )?

**Solution** Using the design curves of Figure 13.10 along with Equation 13.13, the solution can be obtained.

- From Figure 13.9, at 20 km/hr and 3.0 seconds, the bulldozer's acceleration is 0.19g.
- From Equation 13.13,

$$a = 88.8 \text{ kN/m}$$

$$b = -107.3 \text{ kN/m}$$

$$c = 17.0 \text{ kN/m}$$

Thus,  $FS = 1.03$

This value can be confirmed using Figure 13.10.

**Comment** This problem solution can now be compared with those of the previous two examples:

Example 13.1.	Cover soil along with no bulldozer loading:	$FS = 1.25$
Example 13.2.	Cover soil plus bulldozer moving up slope:	$FS = 1.24$
Example 13.3.	Cover soil plus bulldozer moving down slope:	$FS = 1.03$

The inherent danger of a bulldozer moving down the slope is readily apparent. Note, that the same result comes about by the bulldozer decelerating instead of accelerating. The sharp braking action of the bulldozer is arguably the more severe condition, due to the extremely short times involved when stopping forward motion. Clearly, only in unavoidable situations should the cover soil placement equipment be allowed to work down the slope. If it is unavoidable, an analysis should be made of the specific stability situation and the construction specifications should reflect the precise conditions made in the design. The maximum weight and ground contact pressure of the equipment should be stated along with suggested operator movement of the cover soil placement operations. Truck traffic on the slopes can also give stresses as high or even higher than illustrated here and should be avoided in all circumstances.

### 13.4.3 Inclusion of Seepage Forces

The previous sections presented the general problem of slope stability analysis of cover soils placed on slopes under different conditions. The tacit assumption throughout was that either permeable soil or a drainage layer was placed above the barrier layer with adequate flow capacity to efficiently and safely remove permeating water away from the cross section. The amount of water to be removed is obviously a site-specific situation. Note that, in extremely arid areas, or with very low permeability cover soils, drainage may not be required, although this is generally the exception.

Unfortunately, adequate drainage of final covers has sometimes not been available and seepage-induced slope stability problems have occurred. Figure 13.11 shows a final cover slope failure during a heavy raining. The following situations have resulted in seepage-induced slides:

- Drainage soils with hydraulic conductivity (permeability) too low for site-specific conditions.
- Inadequate drainage capacity at the toe of long slopes, where seepage quantities accumulate and are at their maximum.

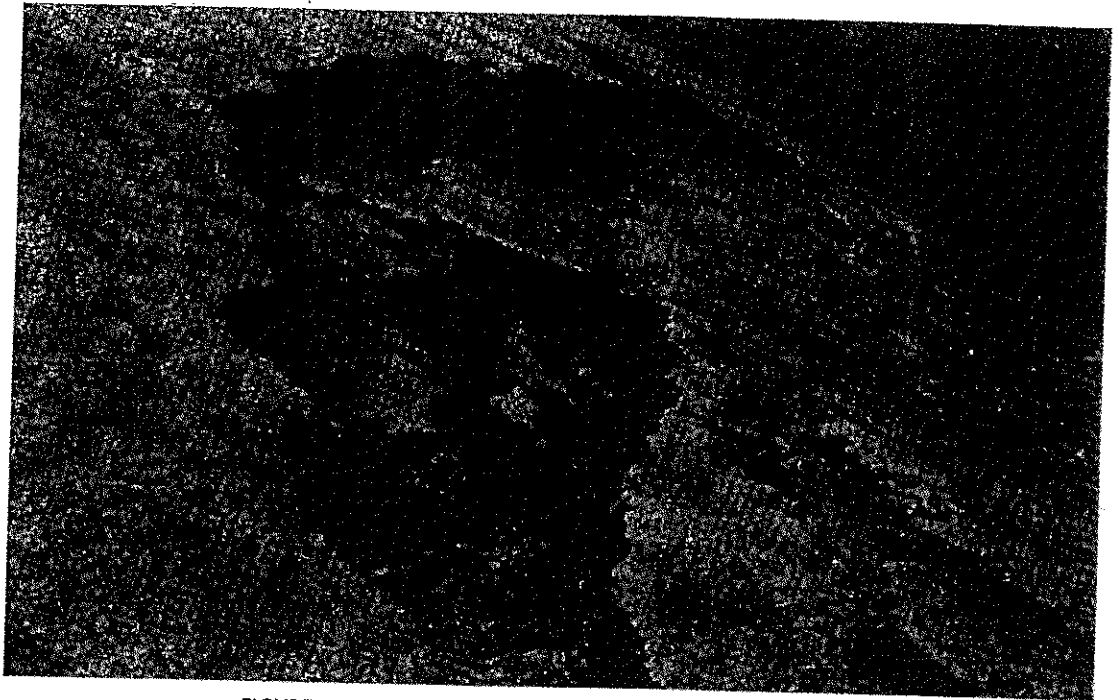


FIGURE 13.11 Final Cover Slope Failure during a Heavy Raining

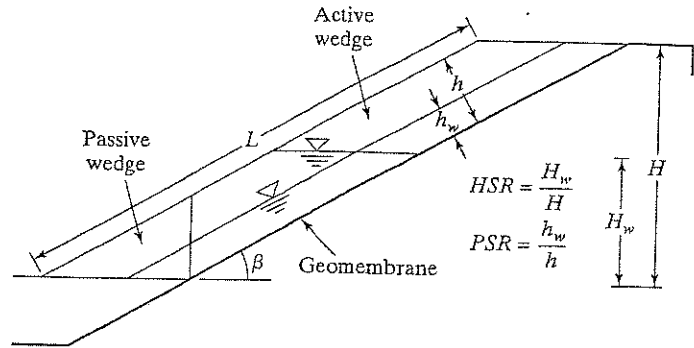
- Fine, cohesionless, cover soil particles migrating through the filter (if one is present) either clogging the drainage layer, or accumulating at the toe of the slope, thereby decreasing the as-constructed outlet permeability over time.
- Freezing of the outlet drainage at the toe of the slope, while the top of the slope thaws, thereby mobilizing seepage forces against the ice wedge at the toe.

If seepage forces of the types described occur, a variation in slope stability design methodology is required. Such an analysis is the focus of this subsection. (See Koerner and Soong, 1998; and Qian, 1997; also, Thiel and Stewart, 1993; and Soong and Koerner, 1996.)

Consider a cover soil of uniform thickness placed directly above a geomembrane at a slope angle of  $\beta$ , as shown in Figure 13.12. What is different from previous examples, however, is that within the cover soil there can exist a saturated soil zone for part or all of the thickness. The saturated boundary is shown as two possibly different phreatic surface orientations. This is because seepage can be built up in the cover soil in two different ways: a horizontal buildup from the toe upward, or a parallel-to-slope buildup outward. These two hypotheses are defined and quantified as a horizontal submergence ratio (HSR) and a parallel submergence ratio (PSR). The dimensional definitions of both ratios are given in Figure 13.12.

When analyzing the stability of slopes using the limit equilibrium method, free-body diagrams of the passive and active wedges are taken with the appropriate forces

FIGURE 13.12 Cross Section of a Uniform Thickness Cover Soil on a Geomembrane Illustrating Different Submergence Assumptions and Related Definitions (Soong and Koerner, 1996)



being applied (now including pore water pressures). The formulation for the resulting factor of safety for horizontal seepage buildup and also for parallel-to-slope seepage buildup is described next.

**13.4.3.1 The Case of the Horizontal Seepage Buildup.** Figure 13.13 shows the free-body diagram of both the active and passive wedge assuming horizontal seepage buildup. Horizontal seepage buildup can occur when toe blockage occurs due to inadequate outlet capacity, contamination or physical blocking of outlets, or freezing conditions at the outlets.

All symbols used in Figure 13.13 were previously defined except the following:

- $\gamma_{sat}$  = saturated unit weight of the cover soil
- $\gamma_t$  = dry unit weight of the cover soil
- $\gamma_w$  = unit weight of water
- $H$  = vertical height of the slope measured from the toe
- $H_w$  = vertical height of the free water surface measured from the toe
- $U_h$  = resultant of the pore pressures acting on the interwedge surfaces
- $U_n$  = resultant of the pore pressures acting perpendicular to the slope
- $U_v$  = resultant of the vertical pore pressures acting on the passive wedge

The expression for determining the factor of safety can be derived as follows:

Considering the active wedge,

$$W_A = \frac{\gamma_{sat} \cdot h \cdot (2 \cdot H_w \cdot \cos \beta - h)}{\sin 2\beta} + \frac{\gamma_{dry} \cdot h \cdot (H - H_w)}{\sin \beta} \quad (13.14)$$

$$U_n = \frac{\gamma_w \cdot h \cdot \cos \beta \cdot (2 \cdot H_w \cdot \cos \beta - h)}{\sin 2\beta} \quad (13.15)$$

$$U_h = 0.5 \cdot \gamma_w \cdot h^2 \quad (13.16)$$

$$N_A = W_A \cdot \cos \beta + U_h \cdot \sin \beta - U_n \quad (13.17)$$

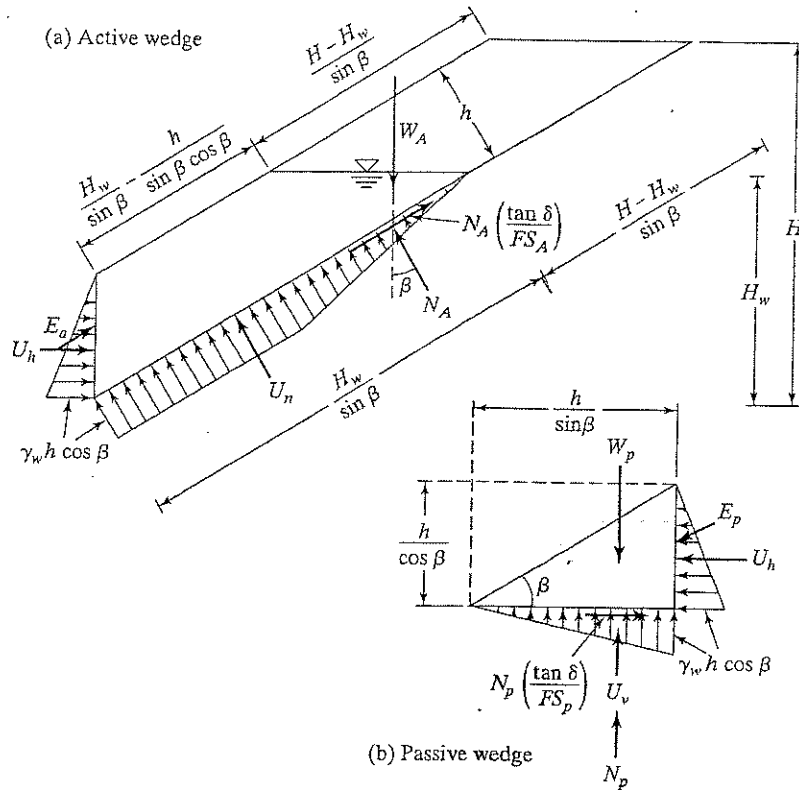


FIGURE 13.13 Limit Equilibrium Forces Involved in a Finite Length Slope of Uniform Cover Soil with Horizontal Seepage Buildup

The interwedge force acting on the active wedge can then be expressed as

$$E_A = W_A \cdot \sin \beta + U_h \cdot \cos \beta - \frac{N_A \cdot \tan \delta}{FS}$$

The passive wedge can be considered in a similar manner and the following expressions result:

$$W_P = \frac{\gamma_{\text{sat}} \cdot h^2}{\sin 2\beta} \tag{13.18}$$

$$U_v = U_h \cdot \cot \beta \tag{13.19}$$

The interwedge force acting on the passive wedge can then be expressed as

$$E_P = \frac{U_h \cdot (FS) - (W_P - U_v) \cdot \tan \phi}{\sin \beta \cdot \tan \phi - \cos \beta \cdot (FS)}$$

By setting  $E_A = E_P$ , the following equation can be arranged in the form of  $ax^2 + bx + c = 0$ , which in this case is

$$a \cdot FS^2 + b \cdot FS + c = 0$$

The resulting *FS*-value is then obtained from the conventional solution of the quadratic equation as

$$FS = \frac{-b \pm (b^2 - 4 \cdot a \cdot c)^{0.5}}{2 \cdot a} \quad (13.20)$$

where

$$a = W_A \cdot \sin \beta \cdot \cos \beta - U_h \cdot \cos^2 \beta + U_h$$

$$b = -W_A \cdot \sin^2 \beta \cdot \tan \phi + U_h \cdot \sin \beta \cdot \cos \beta \cdot \tan \phi - N_A \cdot \cos \beta \cdot \tan \delta - (W_P - U_v) \cdot \tan \phi$$

$$c = N_A \cdot \sin \beta \cdot \tan \delta \cdot \tan \phi$$

**13.4.3.2 The Case of Parallel-to-Slope Seepage Buildup.** Figure 13.14 shows the free body diagrams of both the active and passive wedges with seepage buildup in the direction parallel to the slope. Parallel seepage buildup can occur when soils placed above a geomembrane are initially too low in their hydraulic conductivity, or become too low due to long-term clogging from overlying soils that are not filtered. The individual forces, friction angles, and slope angles involved in Figure 13.14 are listed as follows:

$W_A$  = weight of the active wedge (area times unit weight), lb/ft or kN/m;

$W_P$  = weight of the passive wedge (area times unit weight), lb/ft or kN/m;

$\beta$  = angle of the slope, degree;

$H$  = height of the cover soil slope from the toe of the cover soil to the top of the slope (see Figure 13.14), ft or m;

$h$  = thickness of the soil layer (perpendicular to the slope), ft or m;

$h_w$  = depth of seepage water in the soil layer (perpendicular to the slope), ft or m;

$\gamma$  = moisture unit weight of the soil layer, lb/ft<sup>3</sup> or kN/m<sup>3</sup>;

$\gamma_{sat}$  = saturated unit weight of the soil layer, lb/ft<sup>3</sup> or kN/m<sup>3</sup>;

$\gamma_w$  = unit weight of water, 62.4 lb/ft<sup>3</sup> or 9.81 kN/m<sup>3</sup>;

$\phi$  = friction angle of the cover soil, degree;

$\delta$  = interface friction angle between the soil layer and geomembrane, degree;

$N_A$  = normal force acting on bottom of the active wedge, lb/ft or kN/m;

$F_A$  = frictional force acting on bottom of the active wedge, lb/ft;

$U_{AN}$  = resultant of the pore water pressures acting on bottom of the active wedge (perpendicular to the slope), lb/ft or kN/m;

$U_{AH}$  = resultant of the pore water pressures acting on lower lateral side of the active wedge (perpendicular to the interface between the active and passive wedges), lb/ft or kN/m;

$E_A$  = force from passive wedge acting on active wedge (unknown in magnitude but assumed direction parallel to the slope), lb/ft or kN/m;

$N_P$  = normal force acting on the bottom of passive wedge, lb/ft or kN/m;

$F_P$  = frictional force acting on the bottom of passive wedge, lb/ft or kN/m;

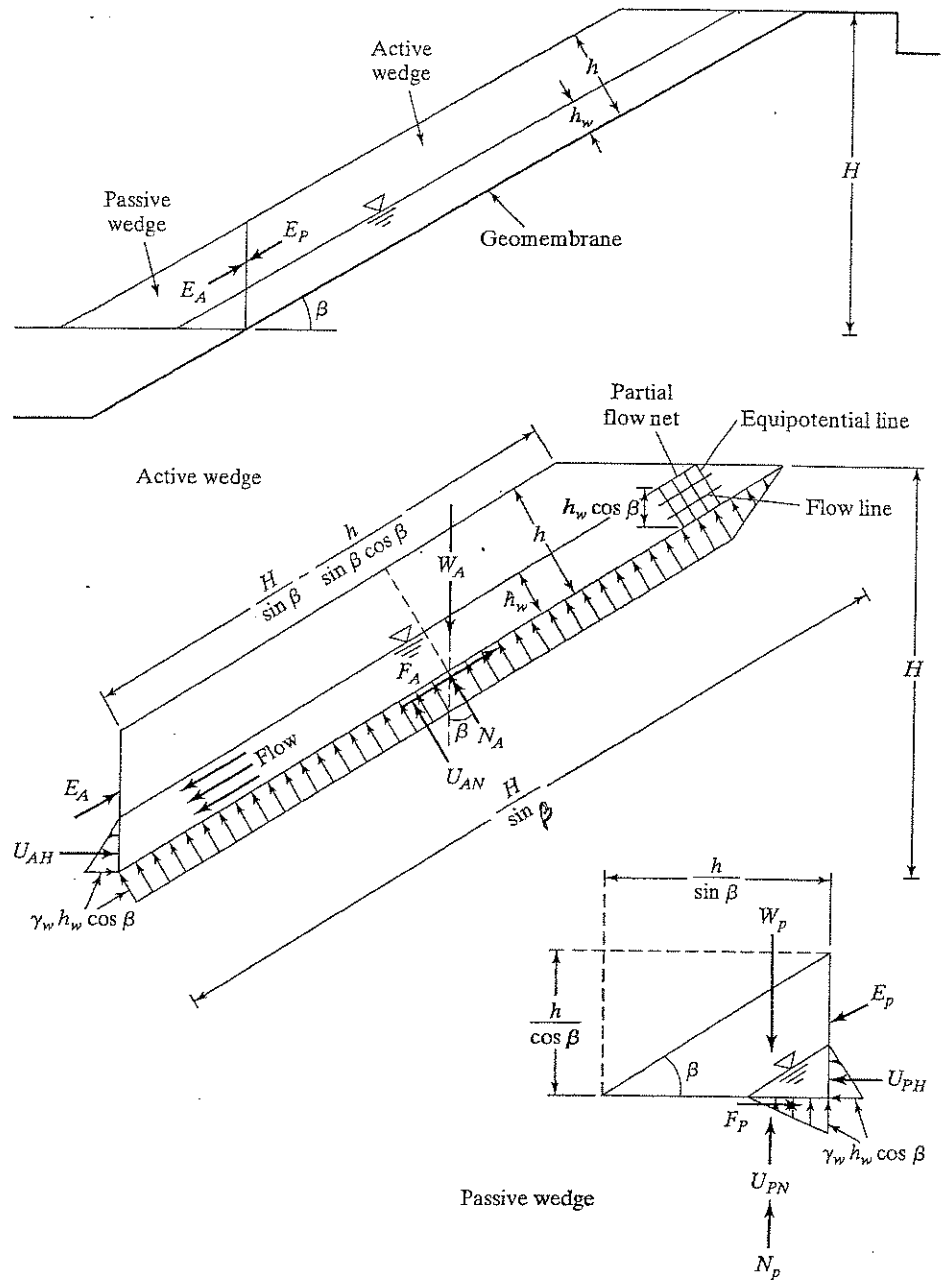


FIGURE 13.14 Cross Section of Sand Layer over Geomembrane on Side Slope with Seepage Parallel to Slope.



$U_H$  = resultant of the pore water pressures acting on lateral side of the active wedge or passive wedge (perpendicular to the lateral side), lb/ft or kN/m,  $U_H = U_{AH} = U_{PH}$ ;

$U_{PN}$  = resultant of the pore water pressures acting on bottom of the passive wedge (perpendicular to bottom of the passive wedge), lb/ft or kN/m;

$E_P$  = force from active wedge acting on passive wedge (unknown in magnitude but assumed direction parallel to the slope), lb/ft or kN/m,  $E_A = E_P$ ;

$FS$  = factor of safety for stability of the cover soil mass.

Considering the force equilibrium of the active wedge (Figure 13.14), we obtain

$$\begin{aligned} \Sigma F_Y = 0: \quad N_A + U_{AN} &= W_A \cdot \cos \beta + U_{AH} \cdot \sin \beta \\ N_A &= W_A \cdot \cos \beta - U_{AN} + U_{AH} \cdot \sin \beta \end{aligned} \quad (13.21)$$

$$\begin{aligned} \Sigma F_X = 0: \quad F_A + E_A + U_{AH} \cdot \cos \beta &= W_A \cdot \sin \beta \\ E_A &= W_A \cdot \sin \beta - U_{AH} \cdot \cos \beta - F_A \end{aligned} \quad (13.22)$$

$$F_A = N_A \cdot \tan \delta / FS \quad (13.23)$$

Substituting Equation 13.21 into Equation 13.23 gives

$$F_A = (W_A \cdot \cos \beta - U_A + U_{AH} \cdot \sin \beta) \cdot \tan \delta / FS \quad (13.24)$$

Substituting Equation 13.24 into Equation 13.22 gives

$$E_A = W_A \cdot \sin \beta - U_{AH} \cdot \cos \beta - (W_A \cdot \cos \beta - U_A + U_{AH} \cdot \sin \beta) \cdot \tan \delta / FS \quad (13.25)$$

Considering the force equilibrium of the passive wedge (Figure 13.14) yields

$$E_P = E_A \quad (13.26)$$

$$\Sigma F_Y = 0: \quad N_P + U_{PN} = W_P + E_P \cdot \sin \beta \quad (13.27)$$

Substituting Equation 13.26 into Equation 13.27 gives

$$N_P = W_P + E_A \cdot \sin \beta - U_{PN} \quad (13.28)$$

Substituting Equation 13.25 into Equation 13.28 gives

$$N_P = W_P - U_{PN} + [W_A \cdot \sin \beta - U_{AH} \cdot \cos \beta - (W_A \cdot \cos \beta - U_A + U_{AH} \cdot \sin \beta) \cdot \tan \delta / FS] \cdot \sin \beta$$

$$N_P = W_P - U_{PN} + W_A \cdot \sin^2 \beta - U_{AH} \cdot \sin \beta \cdot \cos \beta - (W_A \cdot \cos \beta - U_A + U_{AH} \cdot \sin \beta) \cdot \sin \beta \cdot \tan \delta / FS \quad (13.29)$$

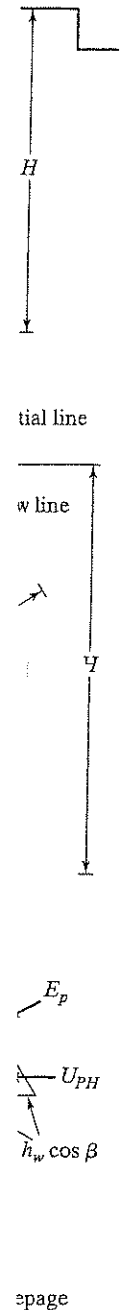
$$\Sigma F_X = 0: \quad F_P = U_{PH} + E_P \cdot \cos \beta \quad (13.30)$$

Substituting Equation 13.26 into Equation 13.30 gives

$$F_P = U_{PH} + E_A \cdot \cos \beta \quad (13.31)$$

Substituting Equation 13.25 into Equation 13.31 gives

$$F_P = U_{PH} + W_A \cdot \sin \beta \cdot \cos \beta - U_{AH} \cdot \cos^2 \beta - (W_A \cdot \cos \beta - U_{AN}$$



$$FS = \frac{N_P \cdot \tan \phi}{F_P} \quad (13.33)$$

Substituting Equations 13.29 and 13.32 into Equation 13.33 gives

$$FS = \frac{(W_P - U_{PN} + W_A \cdot \sin^2 \beta - U_{AH} \cdot \sin \beta \cdot \cos \beta) \cdot \tan \phi - (W_A \cdot \cos \beta - U_A + U_{AH} \cdot \sin \beta) \cdot \sin \beta \cdot \tan \delta \cdot \tan \phi / FS}{U_{PH} + W_A \cdot \sin \beta \cdot \cos \beta - U_{AH} \cdot \cos^2 \beta - (W_A \cdot \cos \beta - U_{AN} + U_{AH} \cdot \sin \beta) \cdot \cos \beta \cdot \tan \delta / FS}$$

$$(U_{PH} + W_A \cdot \sin \beta \cdot \cos \beta - U_{AH} \cdot \cos^2 \beta) \cdot FS - (W_A \cdot \cos \beta - U_{AN} + U_{AH} \cdot \sin \beta) \cdot \cos \beta \cdot \tan \delta = (W_P - U_{PN} + W_A \cdot \sin^2 \beta - U_{AH} \cdot \sin \beta \cdot \cos \beta) \cdot \tan \phi - (W_A \cdot \cos \beta - U_A + U_{AH} \cdot \sin \beta) \cdot \sin \beta \cdot \tan \delta \cdot \tan \phi / FS$$

$$(W_A \cdot \sin \beta \cdot \cos \beta + U_{PH} - U_{AH} \cdot \cos^2 \beta) \cdot FS^2 - (W_A \cdot \cos \beta - U_{AN} + U_{AH} \cdot \sin \beta) \cdot \cos \beta \cdot \tan \delta \cdot FS = (W_P - U_{PN} + W_A \cdot \sin^2 \beta - U_{AH} \cdot \sin \beta \cdot \cos \beta) \cdot \tan \phi \cdot FS - (W_A \cdot \cos \beta - U_A + U_{AH} \cdot \sin \beta) \cdot \sin \beta \cdot \tan \delta \cdot \tan \phi$$

$$(W_A \cdot \sin \beta \cdot \cos \beta + U_{PH} - U_{AH} \cdot \cos^2 \beta) \cdot FS^2 - [W_P \cdot \tan \phi + W_A \cdot (\sin^2 \beta \cdot \tan \phi + \cos^2 \beta \cdot \tan \delta) - U_{AN} \cdot \cos \beta \cdot \tan \delta - U_{PN} \cdot \tan \phi + U_{AH} \cdot \sin \beta \cdot \cos \beta \cdot (\tan \phi - \tan \delta)] \cdot FS + (W_A \cdot \cos \beta - U_A + U_{AH} \cdot \sin \beta) \cdot \sin \beta \cdot \tan \delta \cdot \tan \phi = 0 \quad (13.34)$$

Because  $U_H = U_{PH} = U_{AH}$ ,

$$[W_A \cdot \sin \beta \cdot \cos \beta + U_H \cdot (1 - \cos^2 \beta)] \cdot FS^2 - [W_P \cdot \tan \phi + W_A \cdot (\sin^2 \beta \cdot \tan \phi + \cos^2 \beta \cdot \tan \delta) - U_{AN} \cdot \cos \beta \cdot \tan \delta - U_{PN} \cdot \tan \phi + U_H \cdot \sin \beta \cdot \cos \beta \cdot (\tan \phi - \tan \delta)] \cdot FS + (W_A \cdot \cos \beta - U_{AN} + U_H \cdot \sin \beta) \cdot \sin \beta \cdot \tan \delta \cdot \tan \phi = 0 \quad (13.35)$$

Using  $a \cdot x^2 + b \cdot x + c = 0$

The resulting  $FS$  can be expressed as

$$FS = \frac{-b \pm (b^2 - 4 \cdot a \cdot c)^{0.5}}{2 \cdot a} \quad (13.36)$$

where

$$a = W_A \cdot \sin \beta \cdot \cos \beta + U_H \cdot (1 - \cos^2 \beta)$$

$$b = -[W_P \cdot \tan \phi + W_A \cdot (\sin^2 \beta \cdot \tan \phi + \cos^2 \beta \cdot \tan \delta) - U_{AN} \cdot \cos \beta \cdot \tan \delta - U_{PN} \cdot \tan \phi + U_H \cdot \sin \beta \cdot \cos \beta \cdot (\tan \phi - \tan \delta)]$$

$$c = (W_A \cdot \cos \beta - U_{AN} + U_H \cdot \sin \beta) \cdot \sin \beta \cdot \tan \delta \cdot \tan \phi$$

$$U_{AN} = \gamma_w \cdot h_w \cdot (H - 0.5 h_w \cdot \cos \beta) / \tan \beta \quad (13.37)$$

$$U_H = 0.5 \cdot \gamma_w \cdot h_w^2 \quad (13.38)$$

$$U_{PN} = 0.5 \cdot \gamma_w \cdot h_w^2 / \tan \beta \quad (13.39)$$

$$W_A = 0.5 \cdot [\gamma \cdot (h - h_w) \cdot (2 \cdot H \cdot \cos \beta - h - h_w) + \gamma_{sat} \cdot h_w \cdot (2 \cdot H \cdot \cos \beta - h_w)] / (\sin \beta \cdot \cos \beta) \quad (13.40)$$

$$W_P = 0.5 \cdot [\gamma \cdot (h^2 - h_w^2) + \gamma_{sat} \cdot h_w^2] / (\sin \beta \cdot \cos \beta) \quad (13.41)$$

(13.33)

**EXAMPLE 13.4**

A 44-ft (13.2-m) high and 3(H):1(V) slope has cover sand with a uniform thickness of 2 ft (0.6 m) at a unit weight of 110 lb/ft<sup>3</sup> (17.3 kN/m<sup>3</sup>). The cover sand has a friction angle of 32 degrees and zero cohesion. Seepage occurs parallel to the slope and the seepage water head in the sand layer is 6 inches (0.15 m). The saturated unit weight of sand is 115 lb/ft<sup>3</sup> (18 kN/m<sup>3</sup>). The interface friction angle between sand drainage layer and geomembrane is 22 degrees and zero adhesion. What is the factor of safety at a slope of 3(H)-to-1(V)?

**Solution** The side slope angle is at 18.4° for a 3(H):1(V) slope. Hence,

$$\sin\beta = \sin(18.4^\circ) = 0.316, \cos\beta = \cos(18.4^\circ) = 0.949, \tan\beta = \tan(18.4^\circ) = 0.333.$$

$$H = 44 \text{ ft (13.2 m)}, h = 2 \text{ ft (0.6 m)}, h_w = 0.5 \text{ ft (0.15 m)}, \gamma = 110 \text{ lb/ft}^3 \text{ (17.3 kN/m}^3\text{)},$$

$$\gamma_{\text{sat}} = 115 \text{ lb/ft}^3 \text{ (18 kN/m}^3\text{)}, \gamma_w = 62.4 \text{ lb/ft}^3 \text{ (9.81 kN/m}^3\text{)}, \phi = 32^\circ, \delta = 22^\circ.$$

$$\tan\phi = \tan(32^\circ) = 0.625, \tan\delta = \tan(22^\circ) = 0.404.$$

$$U_{AN} = \gamma_w \cdot h_w \cdot (H - 0.5 h_w \cdot \cos\beta) / \tan\beta \tag{13.37}$$

$$= (62.4)(0.5)[44 - (0.5)(0.5)(0.949)] / (0.333) = 4,100.3 \text{ lb/ft (58.02 kN/m)}$$

$$U_H = 0.5 \cdot \gamma_w \cdot h_w^2 \tag{13.38}$$

$$= (0.5)(62.4)(0.5)^2 = 7.8 \text{ lb/ft (0.11 kN/m)}$$

$$U_{PN} = 0.5 \cdot \gamma_w \cdot h_w^2 / \tan\beta \tag{13.39}$$

$$= (0.5)(62.4)(0.5)^2 / (0.333) = 23.4 \text{ lb/ft (0.33 kN/m)}$$

$$W_A = 0.5 \cdot [\gamma \cdot (h - h_w)(2 \cdot H \cdot \cos\beta - h - h_w) \tag{13.40}$$

$$+ \gamma_{\text{sat}} \cdot h_w \cdot (2 \cdot H \cdot \cos\beta - h_w)] / (\sin\beta \cdot \cos\beta)$$

$$= (0.5)\{(110)(2 - 0.5)[(2)(44)(0.949) - 2 - 0.5]$$

$$+ (115)(0.5)[(2)(44)(0.949) - 0.5]\} / [(0.316)(0.949)]$$

$$= (0.5)(13,366.98 + 4,773.19) / [(0.316)(0.949)] = 30,245.3 \text{ lb/ft (427.6 kN/m)}$$

$$W_P = 0.5 \cdot [\gamma \cdot (h^2 - h_w^2) + \gamma_{\text{sat}} \cdot h_w^2] / (\sin\beta \cdot \cos\beta) \tag{13.41}$$

$$= (0.5)\{(110)[(2)^2 - (0.5)^2] + (115)(0.5)^2\} / [(0.316)(0.949)] = 735.7 \text{ lb/ft (10.4 kN/m)}$$

Using Equation 13.36,

$$a = W_A \cdot \sin\beta \cdot \cos\beta + U_H \cdot (1 - \cos^2\beta)$$

$$= (30,245.3)(0.316)(0.949) + (7.8)[1 - (0.949)^2] = 9,071 \text{ (128 for SI units)}$$

$$b = -[W_P \cdot \tan\phi + W_A \cdot (\sin^2\beta \cdot \tan\phi + \cos^2\beta \cdot \tan\delta) - U_{AN} \cdot \cos\beta \cdot \tan\delta - U_{PN} \cdot \tan\phi$$

$$+ U_H \cdot \sin\beta \cdot \cos\beta \cdot (\tan\phi - \tan\delta)]$$

$$= -\{(735.7)(0.625) + (30,245.3)[(0.316)^2(0.625) + (0.949)^2(0.104)] - (4,100.3)(0.949)(0.404)$$

$$- (23.4)(0.625) + (7.8)(0.316)(0.949)(0.625 - 0.404)\}$$

$$= -(459.8 + 12,892.1 - 1,572.0 - 14.6 + 0.5) = -11,766 \text{ (-166 for SI units)}$$

$$c = (W_A \cdot \cos\beta - U_{AN} + U_H \cdot \sin\beta) \cdot \sin\beta \cdot \tan\delta \cdot \tan\phi$$

$$= [(30,245.3)(0.949) - 4,100.3 + (7.8)(0.316)](0.316)(0.625)(0.404) = 1,963 \text{ (28 for SI units)}$$

$$FS = \frac{-b \pm (b^2 - 4 \cdot a \cdot c)^{0.5}}{2 \cdot a} \tag{13.36}$$

$$11,766 \pm \sqrt{11,766^2 - 4(9,071)(1,963)}$$

33 gives

$$\frac{3 \cdot \cos\beta \cdot \tan\phi}{\cos^2\beta} \cdot \tan\delta / FS$$

$$\frac{U_{AN} + U_{AH} \cdot \sin\beta}{\sin\beta \cdot \tan\delta \cdot \tan\phi / FS} - \frac{U_{AH} \cdot \sin\beta \cdot \cos\beta}{\sin\beta \cdot \tan\delta \cdot \tan\phi / FS} - \frac{U_{AN} + U_{AH} \cdot \sin\beta}{\sin\beta \cdot \tan\delta \cdot \tan\phi} - \frac{U_{AH} \cdot \sin\beta \cdot \cos\beta}{\sin\beta \cdot \tan\delta \cdot \tan\phi} - \frac{W_A \cdot (\sin^2\beta \cdot \tan\phi + \cos^2\beta \cdot \tan\delta)}{\sin\beta \cdot \tan\delta \cdot \tan\phi} = 0 \tag{13.34}$$

$$\frac{(\sin^2\beta \cdot \tan\phi + \cos^2\beta \cdot \tan\delta)}{\tan\delta \cdot \tan\phi} = 0 \tag{13.35}$$

(13.36)

$$U_{AN} \cdot \cos\beta \cdot \tan\delta \tag{13.37}$$

(13.38)

(13.39)

(13.40)



FIGURE 13.15 Sand Layer Failure along Sideslope Caused by Seepage Force

$$\begin{aligned}
 &= \frac{11,766 + 8,198}{(2)(9,071)} \\
 &= 1.10
 \end{aligned}$$

**Comment** The seriousness of seepage forces in a slope of this type is immediately obvious. Had the saturation been 100% of the drainage layer thickness, the FS-value would have been still lower. Furthermore, the result using a horizontal assumption of saturated cover soil with the same saturation ratio will give essentially identical low FS-values. Clearly, the teaching of this example problem is that adequate long-term drainage above the barrier layer in cover soil slopes must be provided to avoid seepage forces from occurring. Figure 13.15 shows a sand layer sliding failure along sideslope caused by seepage force.

An incremental placement method should be implemented for sideslopes higher than the maximum height that can be built in a single lift with a minimum required factor of safety, such as the previous example. Based on the incremental placement method, the first step is to place the sand drainage layer on the sideslope to the maximum unsupported height. As waste is filled against the sideslope to approximately 2 feet (0.6 m) below the protective layer, the next lift of the layer can proceed. This procedure that is illustrated in Figure 13.16 should be continued until the protective layer reaches the top of the sideslope. The heights of the following lifts of the sand drainage layer should not be higher than the calculated maximum unsupported height minus 2

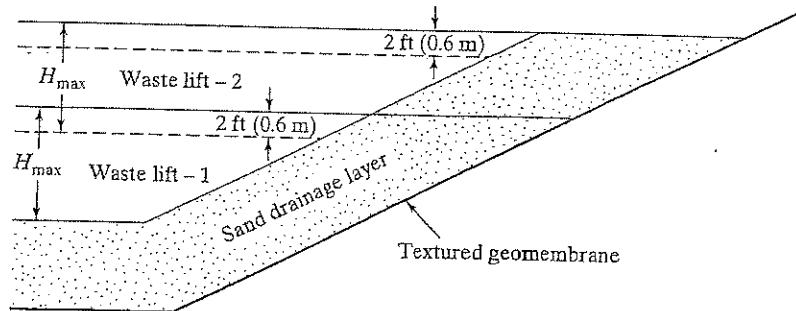


FIGURE 13.16 Incremental Placement of Soil Drainage Layer on Sideslope

feet (0.6 m). The height of the first lift of sand placement can be calculated as shown in the equations that follow (Qian, 1997):

In U.S. units,

$$H = (H_{\text{total}} - 2)/n + 2 \quad (13.42)$$

In SI units,

$$H = (H_{\text{total}} - 0.6)/n + 0.6 \quad (13.43)$$

where  $H$  = height of the first step of sand placement on the sideslope (see Figure 13.14), ft or m;

$H_{\text{total}}$  = total height of the cover sand slope from the toe of the cover sand to the top of the slope (see Figure 13.16), ft or m;

$n$  = number of the placement steps.

### EXAMPLE 13.5

Continue the calculations of Example 13.4 and use the incremental method to achieve a factor of safety no less than 1.2 for the cover sand resting on the sideslope?

**Solution** Use the incremental method to place drainage sand on the side slope to achieve a minimum factor of safety of 1.2. Try three steps of sand placement ( $n = 3$ ) on the sideslope.

$$\begin{aligned} H &= (H_{\text{total}} - 2)/n + 2 \\ &= (44 - 2)/3 + 2 = 14 + 2 = 16 \text{ ft (4.8 m)} \end{aligned} \quad (13.42)$$

So,

$$H = 16 \text{ ft (4.8 m)}, h = 2 \text{ ft (0.6 m)}, h_w = 0.5 \text{ ft (0.15 m)}, \gamma = 110 \text{ lb/ft}^3 (17.3 \text{ kN/m}^3),$$

$$\gamma_{\text{sat}} = 115 \text{ lb/ft}^3 (18 \text{ kN/m}^3), \gamma_w = 62.4 \text{ lb/ft}^3 (9.81 \text{ kN/m}^3), \phi = 32^\circ, \delta = 22^\circ.$$

$$\tan \phi = \tan(32^\circ) = 0.625, \quad \tan \delta = \tan(22^\circ) = 0.404,$$

$$\sin \beta = \sin(18.4^\circ) = 0.316, \quad \cos \beta = \cos(18.4^\circ) = 0.949,$$

$$U_{AN} = \gamma_w \cdot h_w \cdot (H - 0.5 h_w \cdot \cos \beta) / \tan \beta \quad (13.37)$$

$$= (62.4)(0.5)[16 - (0.5)(0.5)(0.949)] / (0.333) = 1,476.9 \text{ lb/ft (20.90 kN/m)}$$

$$U_H = 0.5 \cdot \gamma_w \cdot h_w^2 \quad (13.38)$$

$$= (0.5)(62.4)(0.5)^2 = 7.8 \text{ lb/ft (0.11 kN/m)}$$

$$U_{PN} = 0.5 \cdot \gamma_w \cdot h_w^2 / \tan \beta \quad (13.39)$$

$$= (0.5)(62.4)(0.5)^2 / (0.333) = 23.4 \text{ lb/ft (0.33 kN/m)}$$

$$W_A = 0.5 \cdot [\gamma \cdot (h - h_w)(2 \cdot H \cdot \cos \beta - h - h_w) + \gamma_{sat} \cdot h_w \cdot (2 \cdot H \cdot \cos \beta - h_w)] / (\sin \beta \cdot \cos \beta) \quad (13.40)$$

$$= (0.5)\{(110)(2 - 0.5)[(2)(16)(0.949) - 2 - 0.5] + (115)(0.5)[(2)(16)(0.949) - 0.5]\} / [(0.316)(0.949)]$$

$$= (0.5)(4,598.22 + 1,717.41) / [(0.316)(0.949)] = 10,530.1 \text{ lb/ft (148.9 kN/m)}$$

$$W_P = 0.5 \cdot [\gamma \cdot (h^2 - h_w^2) + \gamma_{sat} \cdot h_w^2] / (\sin \beta \cdot \cos \beta) \quad (13.41)$$

$$= (0.5)\{(110)[(2)^2 - (0.5)^2] + (115)(0.5)^2\} / [(0.316)(0.949)] = 735.7 \text{ lb/ft (10.4 kN/m)}$$

Equation 13.36 yields

$$a = W_A \cdot \sin \beta \cdot \cos \beta + U_H \cdot (1 - \cos^2 \beta)$$

$$= (10,530.1)(0.316)(0.949) + (7.8)[1 - (0.949)^2] = 3,159 \text{ (45 for SI units)}$$

$$b = -[W_P \cdot \tan \phi + W_A \cdot (\sin^2 \beta \cdot \tan \phi + \cos^2 \beta \cdot \tan \delta) - U_{AN} \cdot \cos \beta \cdot \tan \delta - U_{PN} \cdot \tan \phi + U_H \cdot \sin \beta \cdot \cos \beta \cdot (\tan \phi - \tan \delta)]$$

$$= -\{(735.7)(0.625) + (10,530.1)[(0.316)^2(0.625) + (0.949)^2(0.404)] - (1,476.9)(0.949)(0.404) - (23.4)(0.625) + (7.8)(0.316)(0.949)(0.625 - 0.404)\}$$

$$= -(459.8 + 4,488.5 - 566.2 - 14.6 + 0.5) = -4,368 \text{ (-62 for SI units)}$$

$$c = (W_A \cdot \cos \beta - U_{AN} + U_H \cdot \sin \beta) \cdot \sin \beta \cdot \tan \delta \cdot \tan \phi$$

$$= [(10,530.1)(0.949) - 1,476.9 + (7.8)(0.316)](0.316)(0.625)(0.404) = 680 \text{ (10 for SI units)}$$

$$FS = \frac{-b \pm (b^2 - 4 \cdot a \cdot c)^{0.5}}{2 \cdot a} \quad (13.36)$$

$$= \frac{4,368 + [(-4,368)^2 - (4)(3,159)(680)]^{0.5}}{(2)(3,159)}$$

$$= \frac{4,368 + 3,238}{(2)(3,159)}$$

$$= 1.20$$

Thus, based on the above calculation, the first step is to place the drainage sand on the sideslope to a height of 16 feet (4.8 m). As waste is filled against the sideslope to approximately 2 feet (0.6 m) below the protective layer, the next lift of 14 feet (4.2 m) can be placed. This procedure should be continued until the protective layer reaches the top of the sideslope.

#### 13.4.4 Inclusion of Seismic Forces

In areas of anticipated earthquake activity, the slope stability analysis of a final cover soil over an engineered landfill, abandoned dump, or remediated site must consider seismic forces. In the United States, the Environmental Protection Agency (EPA)

# ATTACHMENT B

## DOZER SPECIFICATIONS FROM MANUFACTURER

Specifications | Track-Type Tractors

• Low Ground Pressure (LGP)

1



D5C LGP	
1 kW	90 HP
1000 kg	19,800 lb
3204	
2400	
4	
4 mm	4.5"
7 mm	5"
1.2 L	318 in <sup>3</sup>
6	
10 mm	26"
14 m	7'0.4"
83 m <sup>2</sup>	4389 in <sup>2</sup>
72 m	5'8"
1.75 m	5'9.2"
1.72 m	8'11"
1.9 m	13'4"
1.95 m	9'9.8"
—	
1.38 m	7'10"
1.4 mm	14.2"
—	
—	
1.26 m	10'8"
1.95 m	9'8"
167 L	44 U.S. gal

For D5C LGP Series II

MODEL	D4H LGP Series III		D5H LGP Series II		D6D LGP		D6H LGP Series II	
Flywheel Power	86 kW	116 HP	97 kW	130 HP	104 kW	140 HP	127 kW	170 HP
Operating Weight*								
(Power Shift)	12 196 kg	26,830 lb	15 337 kg	33,818 lb	17 373 kg	38,300 lb	19 814 kg	43,590 lb
(Direct Drive)	12 356 kg	27,180 lb	15 419 kg	33,999 lb	—	—	19 989 kg	43,976 lb
(Power Shift Differential Steer)	—		—		—		20 060 kg 44,131 lb	
Engine Model	3304		3304		3306		3306	
Rated Engine RPM	2200		2200		1900		1900	
No. of Cylinders	4		4		6		6	
Bore	121 mm	4.75"	121 mm	4.75"	121 mm	4.75"	121 mm	4.75"
Stroke	152 mm	6"	152 mm	6"	152 mm	6"	152 mm	6"
Displacement	7 L	425 in <sup>3</sup>	7 L	425 in <sup>3</sup>	10.5 L	638 in <sup>3</sup>	10.5 L	638 in <sup>3</sup>
Track Rollers (Each Side)	7		8		7		8	
Width of Standard Track Shoe	760 mm	30"	860 mm	34"	910 mm	36"	915 mm	36"
Length of Track on Ground	2.62 m	8'7"	3.12 m	10'3"	2.87 m	9'5"	3.27 m	10'8.5"
Ground Contact Area (W/Std. Shoe)	3.98 m <sup>2</sup>	6170 in <sup>2</sup>	5.37 m <sup>2</sup>	8320 in <sup>2</sup>	5.25 m <sup>2</sup>	8136 in <sup>2</sup>	5.97 m <sup>2</sup>	9254 in <sup>2</sup>
Track Gauge	2.00 m	6'6"	2.16 m	7'1"	2.11 m	6'9"	2.23 m	7'3"
GENERAL DIMENSIONS:								
Height (Stripped Top)**	2.20 m	7'3"	2.30 m	7'6.5"	2.05 m	6'8"	2.32 m	7'7"
Height (To Top of ROPS Canopy)	3.63 m	9'11.4"	3.12 m	10'3"	2.92 m	9'7.5"	3.16 m	10'5"
Height (To Top of Cab ROPS)	—	—	3.18 m	10'5"	—	—	3.16 m	10'5"
Overall Length (With P Blade)	4.77 m	15'8"	5.30 m	17'6.3"	—	—	5.18 m	17'0"
(Without Blade)	—	—	4.13 m	13'7"	—	—	4.49 m	14'9"
Overall Length (With S Blade)	—	—	—	—	5.16 m	16'11"	—	—
(Without Blade)	—	—	—	—	3.94 m	12'11"	—	—
Width (Over Trunnion)	—	—	3.26 m	10'8.4"	—	—	3.43 m	11'3"
Width (W/O Trunnion — Std. Shoe)	2.76 m	9'1"	3.02 m	9'11"	—	—	3.14 m	10'3.6"
Width (With Standard Shoe)	—	—	—	—	3.02 m	9'11"	—	—
Ground Clearance	363 mm	14.3"	529 mm	20.8"	310 mm	12.2"	382 mm	15"
Blade Types and Widths:								
Straight	3.26 m	10'8.2"	3.65 m	12'0"	3.71 m	12'2"	3.99 m	13'1"
Angle	—	—	—	—	—	—	—	—
Power Angle & Tilt	—	—	3.98 m	13'0.1"	—	—	—	—
"P". Straight	3.26 m	10'8.2"	—	—	—	—	—	—
Angled	3.00 m	9'10.1"	3.66 m	11'11.9"	—	—	—	—
Fuel Tank Refill Capacity	200 L	52 U.S. gal	246 L	65 U.S. gal	295 L	78 U.S. gal	337 L	89 U.S. gal

\*Operating Weight includes lubricants, coolant, full fuel tank, straight bulldozer, hydraulic controls and fluid, ROPS canopy and operator and rigid drawbar.  
D5H Series II with P-blade.  
\*\*Height (stripped top) — without ROPS canopy, exhaust, seat back or other easily removed encumbrances.  
Note: D4H LGP Series III has P-blade.



**APPENDIX I**

**Anchor Trench Calculation Package**

Date: July 1, 2018  
 Project No.: 1777449  
 Subject: Anchor Trench Design - Top of Slope for 4:1 Slope  
 Project: Plant McDonough AP-1 and AP-3/4 Closure Design

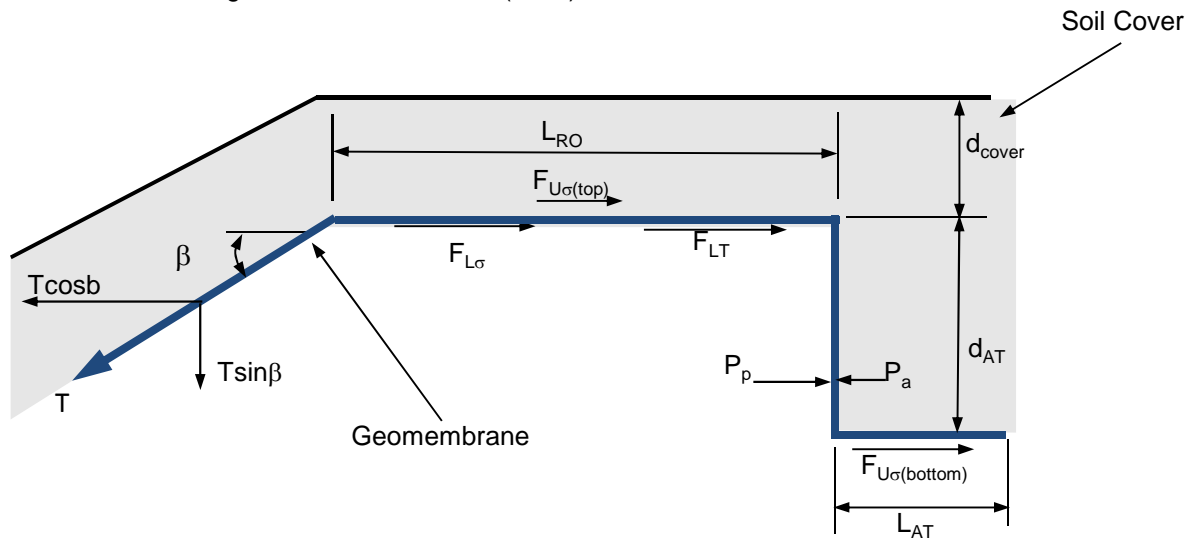
Made by: DM  
 Checked by: LJ / LS  
 Reviewed by: GLH

### OBJECTIVE

Determine the runout length, trench width, and trench depth required to prevent wind and water from moving under the geosynthetic of the final cover system.

### METHOD

The anchor trench design is based on Koerner (1998) and is summarized below:



$$T_{\text{allow}} \cos \beta = F_{U\sigma(\text{top})} + F_{L\sigma} + F_{LT} - P_a + P_p + F_{U\sigma(\text{bottom})}$$

where :  $T_{\text{allow}}$  = allowable force in geomembrane =  $\sigma_{\text{allow}} t$

$\sigma_{\text{allow}}$  = allowable stress in geomembrane

$t$  = thickness of geomembrane

$\beta$  = side slope angle

$F_{U\sigma(\text{top})}$  = shear force above geomembrane due to cover soil (note that for thin cover soils, tensile cracking will occur, and this value will be negligible)

$$F_{U\sigma(\text{top})} = \sigma_n \tan \delta_U (L_{RO})$$

$F_{L\sigma}$  = shear force below geomembrane due to cover soil

$$F_{L\sigma} = \sigma_n \tan \delta_L (L_{RO})$$

$F_{LT}$  = shear force below geomembrane due to vertical component of  $T_{\text{allow}}$

$$F_{LT} = 0.5 \left( \frac{2T_{\text{allow}} \sin \beta}{L_{RO}} \right) (L_{RO}) \tan \delta_L$$

$F_{U\sigma(\text{bottom})}$  = shear force above geomembrane in trench due to cover soil

$$F_{U\sigma(\text{bottom})} = [\gamma_{AT} (d_{AT} + d_{\text{cover}})] \tan \delta_L L_{AT}$$

$L_{RO}$  = length of geomembrane runout

Date:	July 1, 2018	Made by:	DM
Project No.:	1777449	Checked by:	LJ / LS
Subject:	Anchor Trench Design - Top of Slope for 4:1 Slope	Reviewed by:	GLH
Project:	Plant McDonough AP-1 and AP-3/4 Closure Design		

---

$P_a$  = active earth pressure against the backfill side of the anchor trench

$$P_a = (0.5\gamma_{AT}d_{AT} + \sigma_n)K_a d_{AT}$$

$P_p$  = passive earth pressure against the in-situ side of the anchor trench

$\gamma_{AT}$  = unit weight of soil in anchor trench  
 $d_{AT}$  = depth of the anchor trench  
 $\sigma_n$  = applied normal stress from cover soil

$$P_p = (0.5\gamma_{AT}d_{AT} + \sigma_n)K_p d_{AT}$$

$$\sigma_n = \gamma_{AT}d_{cover}$$

$K_a$  = coefficient of active earth pressure

$$K_a = \tan^2\left(45 - \frac{\phi}{2}\right)$$

$K_p$  = coefficient of passive earth pressure

$$K_p = \tan^2\left(45 + \frac{\phi}{2}\right)$$

$\phi$  = angle of shearing resistance of respective soil

$\delta$  = angle of shearing resistance between geomembrane and adjacent material (i.e. soil or geotextile)

## ASSUMPTIONS

The 50-mil LLDPE Super Gripnet® geomembrane will be used as the final cover liner.

### Geomembrane:

$T_{allow} = 9.2$	kN/m	or	52.5 lb/in	for 50-mil LLDPE Geomembrane Tensile Strength at Break = 105 lb/in, for FS = 2, $T_{allow} = 52.5$ lb/in
$t = 1.3$	mm	or	50 mil	for 40-mil LLDPE Geomembrane Tensile Strength at Break = 112 lb/in, for FS = 2, $T_{allow} = 56$ lb/in

### Soil cover:

$d_{cover} = 0$	m	or	0 ft	No Cover soil for Closure Turf System
$\gamma_{AT} = 17.28$	kN/m <sup>3</sup>	or	110 lb/ft <sup>3</sup>	

### Slope angle:

$\beta = 14.0$	deg (4H:1V)	Slopes range from 2.5H:1V to 4H:1V Shallower slope controls the design
----------------	-------------	---------------------------------------------------------------------------

Date: July 1, 2018  
 Project No.: 1777449  
 Subject: Anchor Trench Design - Top of Slope for 4:1 Slope  
 Project: Plant McDonough AP-1 and AP-3/4 Closure Design

Made by: DM  
 Checked by: LJ / LS  
 Reviewed by: GLH

*Friction angle of soil and interface between soil and geomembrane:*

- $\delta_U = 0$  deg (friction angle between geomembrane and soil above geomembrane, set to zero assuming soil cracking occurs)
- $\delta_L = 25$  deg (conservative interface friction angle between geomembrane and materials below geomembrane, based on Technical Specification)
- $\phi = 25$  deg (conservative friction angle of soil)

*Length of runout and length of anchor trench:*

- $L_{RO} = 0.91$  m or 3 ft As no material is above the liner,  $L_{RO}$  does not factor in design, but set to typical minimum of 3 ft.
- $d_{AT} = 0.61$  m or 2 ft Anchor trench depth of 2 ft set

**CALCULATIONS**

Determine the depth of the anchor trench ( $d_{AT}$ ) such that:

$$T_{allow} \cos \beta = F_{U\sigma(top)} + F_{L\sigma} + F_{LT} - P_a + P_p + F_{U\sigma(bottom)}$$

No Cover soil for Closure Turf System

- $T_{allow} = 9.2$  kN/m
- $\sigma_n = 0$  kPa
- $F_{U\sigma} = 0$  kN/m
- $F_{L\sigma} = 0.0$  kN/m
- $F_{LT} = 1.0$  kN/m
- $F_{U\sigma(bottom)} = 4.9 L_{AT}$
- $K_a = 0.406$  kN/m
- $P_a = 1.303$  kN/m
- $K_p = 2.464$  kN/m
- $P_p = 7.911$  kN/m

$$T_{allow} \cos \beta = 8.9 \text{ kN/m}$$

$$8.9 = 0.0 + 0.0 + 1.0 - 1.303 + 7.911 + 4.9 L_{AT}$$

$$1.3 = 4.9 L_{AT}$$

Solve for the minimum width / length of the anchor trench:

Min Calculated  $L_{AT} = 0.3$  m 0.8 ft Minimum anchor trench width must be greater than calculated minimum

Date: July 1, 2018

Made by: DM

Project No.: 1777449

Checked by: LJ / LS

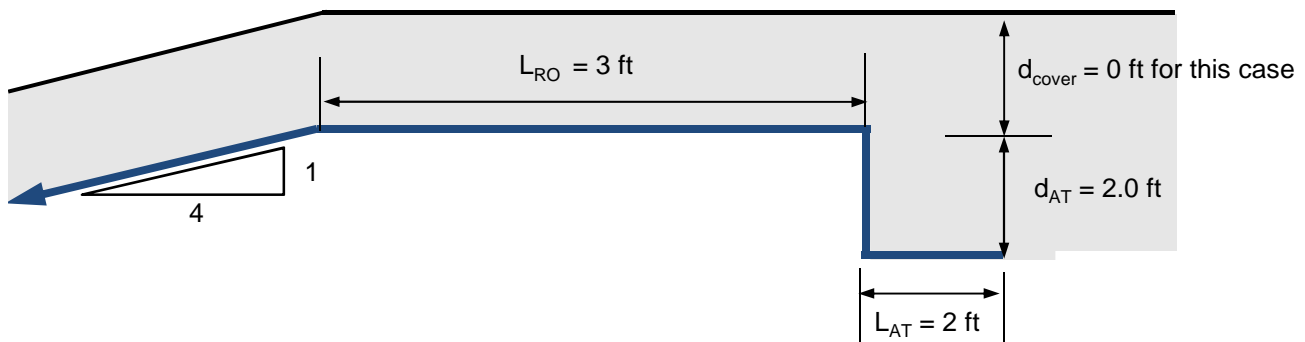
Subject: Anchor Trench Design - Top of Slope for 4:1 Slope

Reviewed by: GLH

Project: Plant McDonough AP-1 and AP-3/4 Closure Design

### SUMMARY

Anchor trenches with a length greater than the calculated minimum of 0.8 ft and a depth of 2 ft are calculated to be adequate. Therefore, the proposed depth and width of the anchor trench 2 ft x 2 ft meet the slope geometry requirements



### REFERENCES

Koerner, R.M. (1998) *Designing with Geosynthetics*, 4th ed., Prentice Hall, New Jersey.

Date: July 1, 2018  
 Project No.: 1777449  
 Subject: Anchor Trench Design - Top of Slope for 2.5:1 Case  
 Project: Plant McDonough AP-1 and AP-3/4 Closure Design

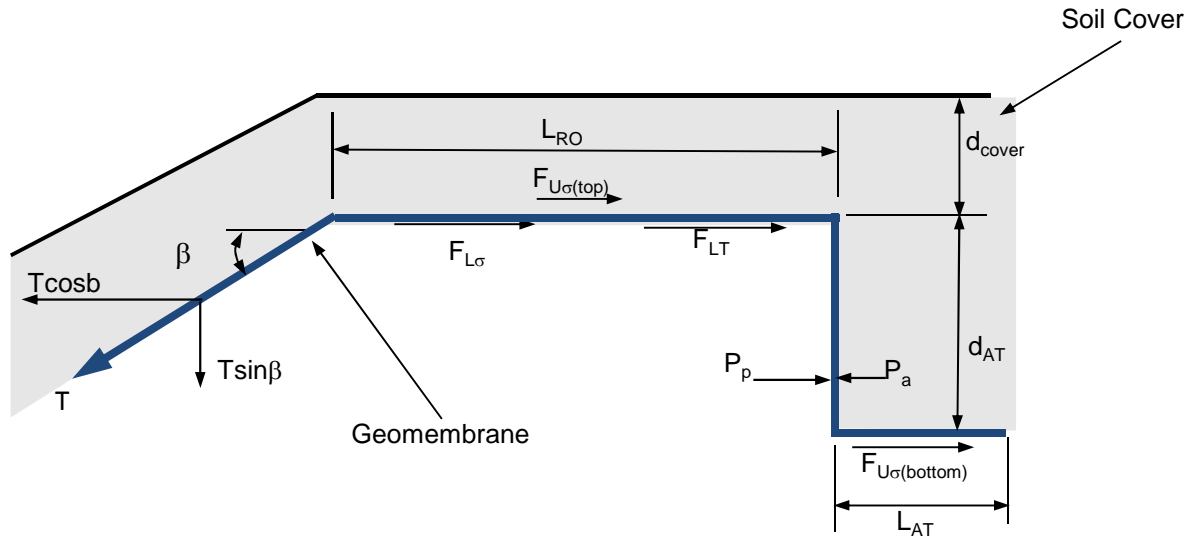
Made by: DM  
 Checked by: LJ / LS  
 Reviewed by: GLH

### OBJECTIVE

Determine the runout length, trench width, and trench depth required to prevent wind and water from moving under the geosynthetic of the final cover system.

### METHOD

The anchor trench design is based on Koerner (1998) and is summarized below:



$$T_{\text{allow}} \cos \beta = F_{U\sigma(\text{top})} + F_{L\sigma} + F_{LT} - P_a + P_p + F_{U\sigma(\text{bottom})}$$

where :  $T_{\text{allow}}$  = allowable force in geomembrane =  $\sigma_{\text{allow}} t$

$\sigma_{\text{allow}}$  = allowable stress in geomembrane

$t$  = thickness of geomembrane

$\beta$  = side slope angle

$F_{U\sigma(\text{top})}$  = shear force above geomembrane due to cover soil (note that for thin cover soils, tensile cracking will occur, and this value will be negligible)

$$F_{U\sigma(\text{top})} = \sigma_n \tan \delta_U (L_{RO})$$

$F_{L\sigma}$  = shear force below geomembrane due to cover soil

$$F_{L\sigma} = \sigma_n \tan \delta_L (L_{RO})$$

$F_{LT}$  = shear force below geomembrane due to vertical component of  $T_{\text{allow}}$

$$F_{LT} = 0.5 \left( \frac{2T_{\text{allow}} \sin \beta}{L_{RO}} \right) (L_{RO}) \tan \delta_L$$

$F_{U\sigma(\text{bottom})}$  = shear force above geomembrane in trench due to cover soil

$$F_{U\sigma(\text{bottom})} = [\gamma_{AT} (d_{AT} + d_{\text{cover}})] \tan \delta_L L_{AT}$$

$L_{RO}$  = length of geomembrane runout

Date: July 1, 2018  
 Project No.: 1777449  
 Subject: Anchor Trench Design - Top of Slope for 2.5:1 Case  
 Project: Plant McDonough AP-1 and AP-3/4 Closure Design

Made by: DM  
 Checked by: LJ / LS  
 Reviewed by: GLH

---

$P_a$  = active earth pressure against the backfill side of the anchor trench

$$P_a = (0.5\gamma_{AT}d_{AT} + \sigma_n)K_a d_{AT}$$

$P_p$  = passive earth pressure against the in-situ side of the anchor trench

$\gamma_{AT}$  = unit weight of soil in anchor trench  
 $d_{AT}$  = depth of the anchor trench  
 $\sigma_n$  = applied normal stress from cover soil

$$P_p = (0.5\gamma_{AT}d_{AT} + \sigma_n)K_p d_{AT}$$

$$\sigma_n = \gamma_{AT}d_{cover}$$

$K_a$  = coefficient of active earth pressure

$$K_a = \tan^2\left(45 - \frac{\phi}{2}\right)$$

$K_p$  = coefficient of passive earth pressure

$$K_p = \tan^2\left(45 + \frac{\phi}{2}\right)$$

$\phi$  = angle of shearing resistance of respective soil

$\delta$  = angle of shearing resistance between geomembrane and adjacent material (i.e. soil or geotextile)

## ASSUMPTIONS

The 50-mil LLDPE Super Gripnet® geomembrane will be used as the final cover liner.

### Geomembrane:

$T_{allow} = 9.2 \text{ kN/m}$  or  $52.5 \text{ lb/in}$  for 50-mil LLDPE Geomembrane Tensile Strength at Break = 105 lb/in, for FS = 2,  $T_{allow} = 52.5 \text{ lb/in}$   
 $t = 1.3 \text{ mm}$  or  $50 \text{ mil}$  for 40-mil LLDPE Geomembrane Tensile Strength at Break = 112 lb/in, for FS = 2,  $T_{allow} = 56 \text{ lb/in}$

### Soil cover:

$d_{cover} = 0 \text{ m}$  or  $0 \text{ ft}$  No Cover soil for Closure Turf System  
 $\gamma_{AT} = 17.28 \text{ kN/m}^3$  or  $110 \text{ lb/ft}^3$

### Slope angle:

$\beta = 21.8 \text{ deg (4H:1V)}$  Slopes range from 2.5H:1V to 4H:1V  
 Shallower slope controls the design



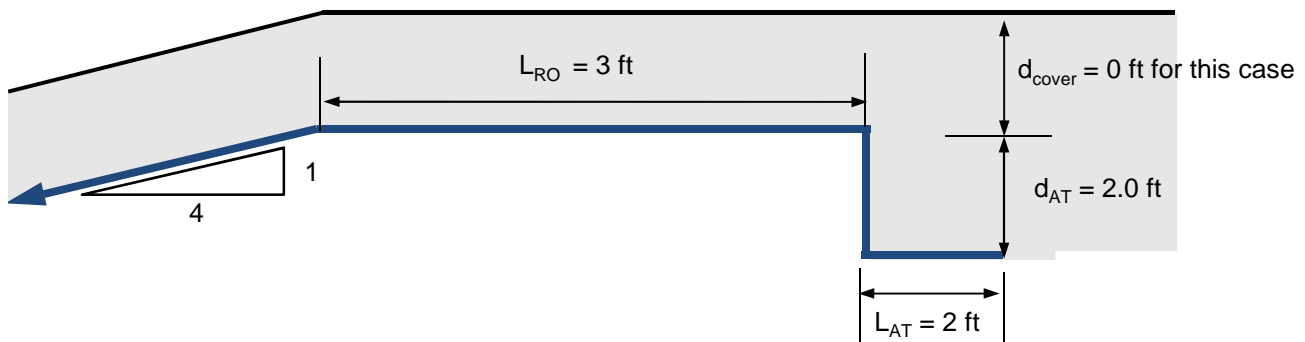


Date: July 1, 2018  
 Project No.: 1777449  
 Subject: Anchor Trench Design - Top of Slope for 2.5:1 Case  
 Project: Plant McDonough AP-1 and AP-3/4 Closure Design

Made by: DM  
 Checked by: LJ / LS  
 Reviewed by: GLH

### SUMMARY

Anchor trenches with a length greater than the calculated minimum of 0.2 ft and a depth of 2 ft are calculated to be adequate. Therefore, the proposed depth and width of the anchor trench 2 ft x 2 ft meet the slope geometry requirements



### REFERENCES

Koerner, R.M. (1998) *Designing with Geosynthetics*, 4th ed., Prentice Hall, New Jersey.

# Super Gripnet® Liner

## LOW DENSITY POLYETHYLENE

AGRU America's structured geomembranes are manufactured on state-of-the-art manufacturing equipment using the flat die calender manufacturing process, a method that produces a more consistent core thickness than other processes, such as the blown film extrusion process. AGRU uses only the highest-grade HDPE and LLDPE resins manufactured in North America.

### PRODUCT DATA

Property	Test Method	Frequency	Minimum Average Values			
Thickness (nominal), mil (mm)	ASTM D5994	Per Roll	50 (1.25)	60 (1.5)	80 (2.0)	100 (2.5)
Thickness (min avg), mil (mm)			47.5 (1.19)	57 (1.43)	76 (1.9)	95 (2.38)
Thickness (min 8 of 10), mil (mm)			45 (1.12)	54 (1.35)	72 (1.8)	90 (2.25)
Thickness (lowest individual), mil (mm)			42.5 (1.06)	51 (1.28)	68 (1.7)	85 (2.13)
Drainage Stud Height, mil (mm)	ASTM D7466	2nd Roll	130 (3.3)	130 (3.3)	130 (3.3)	130 (3.3)
Friction Spike Height, mil (mm)	ASTM D7466	2nd Roll	175 (4.45)	175 (4.45)	175 (4.45)	175 (4.45)
Density, g/cc, maximum	ASTM D792, Method B	200,000 lb	0.939	0.939	0.939	0.939
Tensile Properties (both directions) Strength @ Break, lb/in width (N/mm) Elongation @ Break, % (GL=2.0in)	ASTM D6693, Type IV 2 in/minute	20,000 lb	105 (18.4)	126 (22.1)	168 (29.4)	210 (36.8)
			300	300	300	300
Tear Resistance, lb.s. (N)	ASTM D1004	45,000 lb	30 (133)	40 (178)	53 (236)	64 (285)
Puncture Resistance, lbs. (N)	ASTM D4833	45,000 lb	55 (245)	70 (311)	90 (400)	110 (489)
Carbon Black Content, % (range)	ASTM D4218	20,000 lb	2-3	2-3	2-3	2-3
Carbon Black Dispersion (Category)	ASTM D5596	45,000 lb	Only near spherical agglomerates: 10 views Cat. 1 or 2			
Oxidative Induction Time, minutes	ASTM D3895, 200°C, 1 atm O <sub>2</sub>	200,000 lb	≥140	≥140	≥140	≥140

AGRU America's geomembranes are certified to pass Low Temp. Brittleness via ASTM D746 (-80°C), Dimensional Stability via ASTM D1204 (±2% @ 100°C). Oven Aging and UV Resistance are tested per GRI GM 17. These product specifications meet or exceed GRI GM 17.

### SUPPLY INFORMATION (STANDARD ROLL DIMENSIONS)

THICKNESS		WIDTH		LENGTH		AREA (APPROX.)	
mil	mm	ft	m	ft	m	ft <sup>2</sup>	m <sup>2</sup>
50	1.25	23	7	500	152	11,500	1,068
60	1.5	23	7	500	152	11,500	1,068
80	2.0	23	7	300	91.4	6,900	640
100	2.5	23	7	300	91.4	6,900	640

Note:

Average roll weight is 5,000 lbs (2,268 kg) for 50 and 60 mil and 4,000 lbs (1,814 kg) for other thicknesses. All rolls are supplied with two slings. Rolls are wound on a 6" core. Special length available upon request. Roll length and width have a tolerance of ±1%. The weight values may change due to project specifications (i.e. absolute minimum thickness or special length) or shipping requirements (i.e. international containerized shipments).

All information, recommendations and suggestions appearing in this literature concerning the use of our products are based upon tests and data believed to be reliable; however, it is the users responsibility to determine the suitability for their own use of the products described herein. Since the actual use by others is beyond our control, no guarantee or warranty of any kind, expressed or implied, is made by AGRU America as to the effects of such use or the results to be obtained, nor does AGRU America assume any liability in connection herewith. Any statement made herein may not be absolutely complete since additional information may be necessary or desirable when particular or exceptional conditions or circumstances exist or because of applicable laws or government regulations. Nothing herein is to be construed as permission or as a recommendation to infringe any patent.



# MicroSpike® Liner

## LINEAR LOW DENSITY POLYETHYLENE

AGRU America's structured geomembranes are manufactured on state-of-the-art manufacturing equipment using the flat die calender manufacturing process, a method that produces a more consistent core thickness than other processes, such as the blown film extrusion process. AGRU uses only the highest-grade HDPE and LLDPE resins manufactured in North America.

### PRODUCT DATA

Property	Test Method	Frequency	Minimum Average Values			
Thickness (nominal ), mil (mm)	ASTM D5994	Per Roll	40 (1.0)	60 (1.5)	80 (2.0)	100 (2.5)
Thickness (min avg ), mil (mm)			38 (0.95)	57 (1.43)	76 (1.9)	95 (2.38)
Thickness (min 8 of 10), mil (mm)			36 (0.90)	54 (1.35)	72 (1.8)	90 (2.25)
Thickness (lowest individual), mil (mm)			34 (0.85)	51 (1.28)	68 (1.7)	85 (2.13)
Asperity Height mils, (mm)	ASTM D7466	2nd Roll	20 (0.51)	20 (0.51)	18 (0.46)	18 (0.46)
Density, g/cc, maximum	ASTM D792, Method B	200,000 lb	0.939	0.939	0.939	0.939
Tensile Properties (both directions)	ASTM D6693, Type IV 2 in/minute	20,000 lb	112 (19.6)	168 (29.4)	224 (39.2)	280 (49)
Strength @ Break, lb/in width (N/mm)			400	400	400	400
Elongation @ Break, % (GL=2.0in)						
Tear Resistance, lb.s. (N)	ASTM D1004	45,000 lb	25 (111)	36 (160)	50 (222)	60 (267)
Puncture Resistance, lbs. (N)	ASTM D4833	45,000 lb	50 (222)	70 (310)	90 (400)	115 (512)
Carbon Black Content, % (range)	ASTM D4218	20,000 lb	2-3	2-3	2-3	2-3
Carbon Black Dispersion (Category)	ASTM D5596	45,000 lb	Only near spherical agglomerates: 10 views Cat.1 or 2			
Oxidative Induction Time, minutes	ASTM D3895, 200°C, 1 atm O <sub>2</sub>	200,000 lb	≥140	≥140	≥140	≥140

AGRU America's geomembranes are certified to pass Low Temp. Brittleness via ASTM D746 (-80°C), Dimensional Stability via ASTM D1204 (±2% @ 100°C). Oven Aging and UV Resistance are tested per GRI GM 17. These product specifications meet or exceed GRI's GM17.

### SUPPLY INFORMATION (STANDARD ROLL DIMENSIONS)

THICKNESS		WIDTH			LENGTH		AREA (APPROX.)	
mil	mm	ft	m		ft	m	ft <sup>2</sup>	m <sup>2</sup>
40	1.0	23	7	Double-Sided	750	229	17,250	1,603
				Single-Sided	800	244	18,400	1,709
60	1.5	23	7	Double-Sided	540	165	12,420	1,154
				Single-Sided	560	171	12,880	1,197
80	2.0	23	7	Double-Sided	410	125	9,430	876
				Single-Sided	425	130	9,775	908
100	2.5	23	7	Double-Sided	335	102	7,705	716
				Single-Sided	340	104	7,820	726

Note:

Average roll weight is 3,900 lbs (1,770 kg). All rolls are supplied with two slings. Rolls are wound on a 6" core. Special length available upon request. Roll length and width have a tolerance of ±1%. The weight values may change due to project specifications (i.e. average or absolute minimum thickness) or shipping requirements (i.e. international containerized shipments).

All information, recommendations and suggestions appearing in this literature concerning the use of our products are based upon tests and data believed to be reliable; however, it is the users responsibility to determine the suitability for their own use of the products described herein. Since the actual use by others is beyond our control, no guarantee or warranty of any kind, expressed or implied, is made by AGRU America as to the effects of such use or the results to be obtained, nor does AGRU America assume any liability in connection herewith. Any statement made herein may not be absolutely complete since additional information may be necessary or desirable when particular or exceptional conditions or circumstances exist or because of applicable laws or government regulations. Nothing herein is to be construed as permission or as a recommendation to infringe any patent.



**APPENDIX J**

**Hydrology and Hydraulic Design for  
AP-3/4**

---

<b>Date:</b>	01 November 2017	<b>Made by:</b>	Jimmy Grimes
<b>Project No.:</b>	1539180 – SCS Project ID MCD15017	<b>Checked by:</b>	Joshua K. Myers
<b>Subject:</b>	Final Closure Hydrology and Hydraulic Design	<b>Reviewed by:</b>	Gregory L. Hebeler
<b>Project:</b>	<b>SOUTHERN COMPANY / MCDONOUGH ASH PONDS 3 AND 4 CLOSURE / GA</b>		

---

## 1.0 OBJECTIVE

The objective of this memo is to outline the design process and present engineering calculations for the proposed storm water system of the Plant McDonough Ash Pond 3 and 4 closure landfill.

## 2.0 METHODOLOGY

Golder is developing a hydrologic and hydraulic model within the AutoCAD Civil 3D Storm and Sanitary Analysis (SSA) program to analyze the proposed landfill closure site. Proposed grading information has been created in order to remove all ash above the existing ash pond pipe culvert (see Figure 1) and relocate the ash to the western portion of the site. For the landfill cap, SCS/GPC have chosen the use of AgruTurf closure turf, a non-permeable liner consisting of fiber "grass" strands and a sand infill overlying an integrated geomembrane or structured geomembrane. Because the liner is non permeable, almost all rainfall on the site will be directly generated into storm runoff. Golder proposes a series of three permanent detention ponds to attenuate this runoff while leaving existing outfall infrastructure in place. The first outfall from the proposed closure site will remain the existing ash culvert, which will handle flow from the basin north of the closure site (see previous technical memo documenting the analysis of this basin) as well as flow from the landfill via an outflow pipe culvert in detention pond 2 (previous calculations had presented a riser structure which is now changed to a culvert with headwall). The second outfall from the closure site will be flow exiting the riser structure of detention pond 3.



### 3.0 PRECIPITATION

NOAA's Atlas 14 is used to determine storm depths for 24 hour storms ranging from the 2 year to 100 year storm events as shown in Table 1. An SCS Type II distribution was used in all subsequent modeling efforts. The design storm used to size all storm infrastructure was taken as the 100 year, 24 hour storm event.

**Table 1: 24 Hour Storm Depths**

Storm Event	Depth (in)
2 year	3.73
5 year	4.45
10 year	5.09
25 year	6.00
50 year	6.74
100 year	7.52
500 year	9.47
1000 year	10.40

### 4.0 FINAL POND STAGE STORAGE

Golder proposes three permanent detention ponds to provide storage capacity and attenuation of floods. Detention Pond 1 and Detention Pond 3 will also serve as sediment basins during various construction phases. Figure 1 shows the location of each pond on site. Tables 2 through 4 give the stage storage curve for each pond.

**Table 2: Stage-Storage Curve for Detention Pond 1**

Elevation	Area (ft <sup>2</sup> )	Area (acres)	Volume (acre-ft)
824	20110	0.46	0.0
826	25336	0.58	1.0
828	34926	0.80	2.4
830	43341	0.99	4.2
832	54936	1.26	6.5
834	65604	1.51	9.2
836	76014	1.75	12.5
838	86821	1.99	16.2

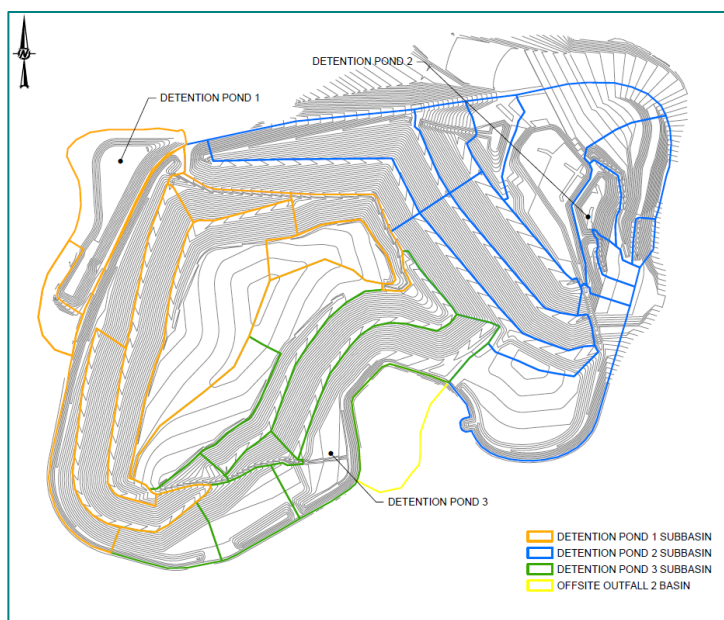
**Table 3: Stage-Storage Curve for Detention Pond 2**

Elevation	Area (ft <sup>2</sup> )	Area (acres)	Volume (acre-ft)
771	0	0.00	0.0
772	1365	0.03	0.0
774	7864	0.18	0.2
776	11858	0.27	0.7
778	14533	0.33	1.3
780	17389	0.40	2.0
782	20420	0.47	2.9
784	23650	0.54	3.9

**Table 4: Stage-Storage Curve for Detention Pond 3**

Elevation	Area (ft <sup>2</sup> )	Area (acres)	Volume (acre-ft)
832.8	100	0.00	0
834	2905	0.07	0.0
836	11594	0.27	0.4
838	27361	0.63	1.3
840	58791	1.35	3.2
842	80138	1.84	6.4
844	97141	2.23	10.5

## 5.0 HYDROLOGY



**Site and Basin Layout; For Expanded View See Next Page**

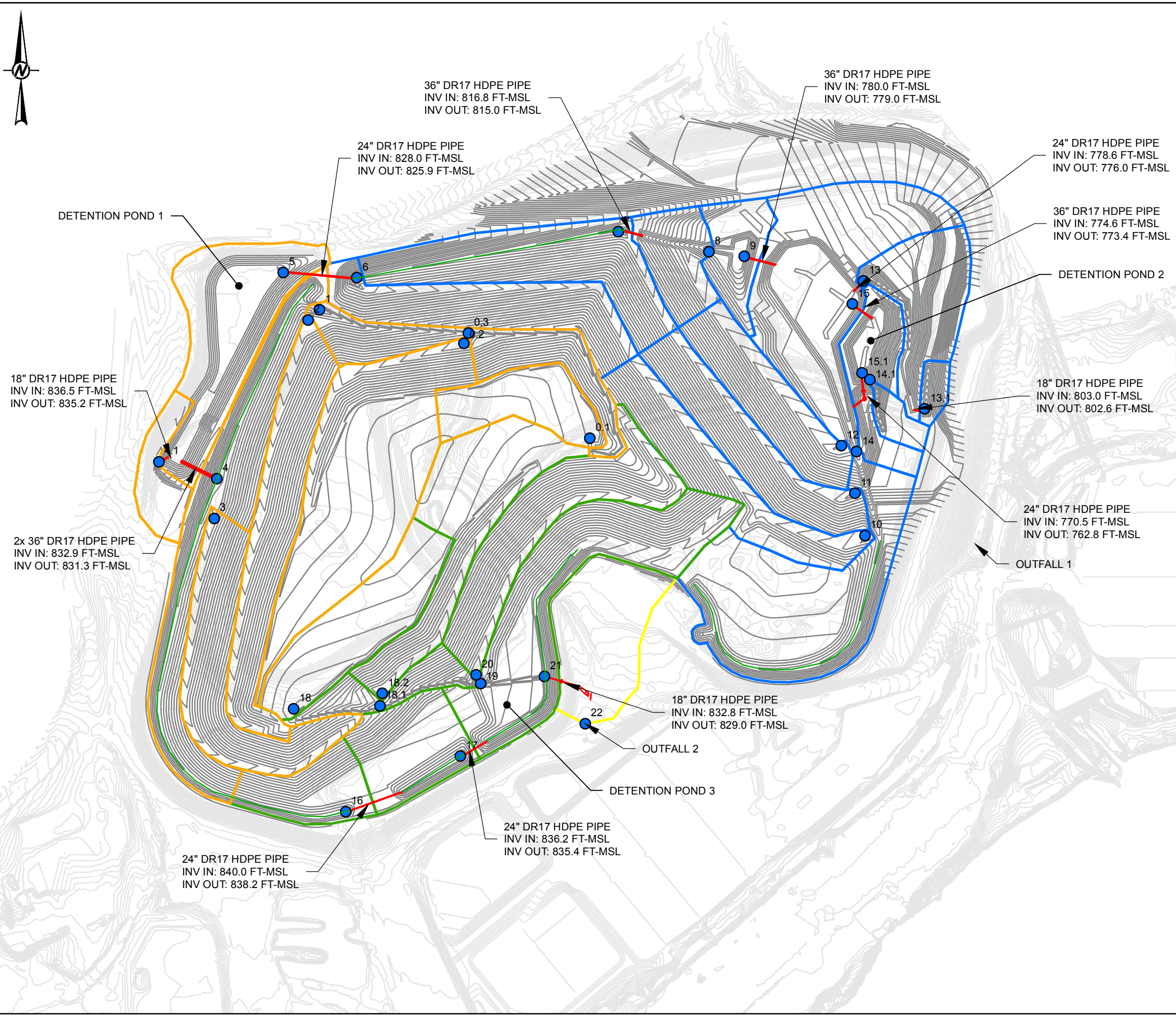
Golder has performed an analysis of the hydrology of the closure system. Watersheds are delineated at multiple "study points" (see Figure 1) so that each hydraulic component in the stormwater system can be sized and checked for adequate stormwater capacity. Curve numbers for each basin consisting of landfill cap are taken to be a value of 95 based on design guidelines provided by AgruTurf (see Attachment A). Areas of landfill which are not be enclosed with closure turf are

also taken to be 95 in order to provide a conservative runoff estimate and to

account for drainage patterns during construction before final grass cover has been established. Curve numbers for off-landfill basins are developed based on existing ground cover conditions and type B soils. Time of concentration values are calculated via the velocity method (see Attachment D). A minimum time of concentration of six minutes was used as recommended by the TR-55 manual (see Attachment B). Storm runoff values were taken directly from the SSA model.

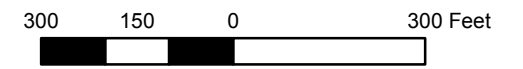
### 5.1 Detention Pond 1

The total watershed contributing to Pond 1 is divided into eight sub-basins. Pond 1 is fed by a culvert at point 4 which transmits runoff from the western side of the landfill. Table 5 shows the hydrologic parameters associated with each basin.



**LEGEND**

- PROPOSED 2' CONTOURS
- EXISTING 2' CONTOURS
- PROPOSED CULVERT
- OFFSITE OUTFALL 2 BASIN
- DETENTION POND 1 SUBBASIN
- DETENTION POND 3 SUBBASIN
- DETENTION POND 2 SUBBASIN



**NOTES**

**REFERENCE**

THE EXISTING TOPOGRAPHY AND CONTOUR ELEVATIONS WERE PROVIDED BY GEORGIA LAND DEPARTMENT AND METRO ENGINEERING AND SURVEYING CO., INC. THE DATE OF THE SURVEY PROVIDED AND SHOWN ON THIS SET OF PLANS IS 10-16-2012. REFER TO THE SURVEY DRAWING TITLED "TOPOGRAPHIC MAP PREPARED FOR GEORGIA POWER COMPANY PLANT MCDONOUGH - GEORGIA STATE PLANE WEST SURVEY FEET - DATE OF PHOTOGRAPHY 10-26-12. PROJECT NO. 13225 - 01-13-2013."

CLIENT  
 GEORGIA POWER COMPANY/  
 SOUTHERN COMPANY SERVICES

PROJECT  
 PLANT MCDONOUGH  
 ASH POND NO. 3 & 4 CLOSURE PLAN

**TITLE**  
**WORKING STORMWATER DESIGN AND BASIN LAYOUT**

CONSULTANT	YYYY-MM-DD	2017-02-02
	PREPARED	JDG
	DESIGN	JDG
	REVIEW	JKM
	APPROVED	GLH

PROJECT No. 1539180 CONTROL Rev. 0 FIGURE 1

Path: C:\GIS\Southern Company\1539180\Plant McDonough\Closure PLAN PROJECT\Closure Phases\Basemap.dwg

1 in IF THIS MEASUREMENT DOES NOT MATCH WHAT IS SHOWN, THE SHEET HAS BEEN MODIFIED FROM ANS/B



**Table 5: Hydrology Parameters for Detention Pond 1**

	Size (acres)	Time of Concentration (mins)	Curve Number	100 Year Storm Peak Runoff (cfs)
Basin 0.1	1.31	10.7	95	11
Basin 0.2	7.22	28.8	95	41
Basin 0.3	1.53	6.0	95	15
Basin 1	1.10	6.1	95	10
Basin 2	3.89	9.1	95	34
Basin 3	3.36	10.0	95	29
Basin 4	4.42	11.7	95	36
Basin 4.1	1.0	6.0	95	9.5
Basin 5	4.1	6.0	95	39

## 5.2 Detention Pond 2

The total watershed contributing to Pond 2 is divided into thirteen sub-basins. Outflow from Pond 1 flows through the northern segment of perimeter ditch and down the northern downslope channel into the pond. Flow generated from runoff on the east side of the landfill is directed into the pond via the southern downslope channel. Runoff from the northeast corner of landfill flows directly into the pond. Table 6 shows the hydrologic parameters associated with each basin.

**Table 6: Hydrology Parameters for Detention Pond 2**

	Size (acres)	Time of Concentration (mins)	Curve Number	100 Year Storm Peak Runoff (cfs)
Basin 6	3.22	12.8	95	26
Basin 7	4.00	6.0	95	38
Basin 8	1.71	7.8	95	16
Basin 9	2.56	6.0	95	24
Basin 10	2.82	7.4	95	26
Basin 11	2.76	7.8	95	25
Basin 12	2.45	6.9	95	23
Basin 13	2.39	6.0	95	5
Basin 13.1	0.34	6.5	95	12
Basin 14	5.61	18.8	95	40
Basin 14.1	0.47	6.0	95	4
Basin 15	5.40	13.1	95	45
Basin 15.1	1.62	6.0	95	15

### 5.3 Detention Pond 3

The total watershed contributing to Pond 3 is broken into eight sub-basins. Several sections of perimeter ditch and roadside channels contribute runoff from the south and west sections of landfill cap. Table 7 shows the hydrologic parameters of each sub-basin.

**Table 7: Hydrology Parameters for Detention Pond 3**

	Size (acres)	Time of Concentration (mins)	Curve Number	100 Year Storm Peak Runoff (cfs)
Basin 16	1.59	13.0	95	13
Basin 17	2.17	11.6	95	18
Basin 18	3.45	22.1	95	23
Basin 18.1	0.48	6.0	95	5
Basin 18.2	3.10	26.4	95	19
Basin 19	0.57	5.3	95	5
Basin 20	3.72	7.0	95	34
Basin 21	5.20	6.8	95	48

### 5.4 South Offsite Basin

Golder performed a hydrologic analysis of the basin contributing to the culvert beneath the road south of the pond 3 outlet. With the addition of outflow from detention pond 3, this culvert and basin are analyzed to ensure existing infrastructure could remain in place. Table 8 gives the hydrologic parameters for the south offsite basin.

**Table 8: Hydrology Parameters for Offsite Basin**

	Size (acres)	Time of Concentration (mins)	Curve Number	100 Year Storm Peak Runoff (cfs)
Basin 22	3.00	6.0	82	24

## 6.0 HYDRAULIC ANALYSES

Golder proposes a stormwater conveyance system to convey water off the landfill surface through a series of ditches, ponds, and culverts. Each component of the system was sized to meet minimum performance and freeboard criteria within the SSA model.

All culvert pipes are shown on the plans to be SDR26 HDPE pipes. For the purpose of this study, all pipes are assumed to be SDR17 pipes, as the contractor has requested to use SDR 17 pipes as conditions in the field dictate. As SDR17 pipes have reduced flow capacity, the entire system is modeled with this

configuration in order to provide a conservative design and allow the contractor to use this pipe configuration as needed.

## 6.1 Detention Pond Outlet Structures

In detention Pond 1 and Pond 3 Golder proposes a riser structure to maximize storage potential while maintaining a minimum of 1 feet of freeboard during the 100 year storm event. The risers in Pond 1 and Pond 3 are designed to be 4 foot by 4 foot box risers. Each riser consists of a low flow conduit at the pond invert, which in each case is a 3" orifice. A mid-level weir and emergency level weir are present at heights which vary between each structure. For a detailed rating curve for each structure see Attachment C. The proposed outlet structure for detention Pond 2 consists of a concrete headwall and pipe culvert. The pipe culvert consists of a 24" SDR17 HDPE pipe which drains to a junction (manhole), after which a separate 24" HDPE pipe conveys flow into the existing culvert located beneath Ash Pond 4. The rating curve for the outlet culvert is calculated within the SSA model. Table 9 shows a summary of the characteristics and performance of each outlet structure.

**Table 9: Summary of Pond Outlet Structures**

	Pond 1	Pond 2	Pond 3
Low Level Conduit Elevation (ft-msl)	828.00	-	832.80
Top of Pond Elevation (ft-msl)	840.0	784.0	846.0
Weir Elevation (ft-msl)	836.0	-	841.0
Top of Riser/Emergency Weir Invert (ft-msl)	838.0	-	843.0
Weir Length (ft)	2.00	-	2.00
Emergency Weir Length (ft)	12.0	-	12.0
Outlet Pipe Size (ft)	2.0	2.0	1.5
100 Year Storm Max Inflow to Pond (cfs)	106	58	121
100 Year Storm Max Outflow (cfs)	12	30	9
100 Year Storm Max Water Level (ft-msl)	837.5	782.4	842.3
100 Year Storm Freeboard (ft)	2.5	1.6*	3.7
1000 Year Storm Max Inflow to Pond (cfs)	123	96	165
1000 Year Storm Max Outflow (cfs)	30	35	20
1000 Year Storm Max Water Level (ft-msl)	838.7	785.8	843.4
1000 Year Storm Freeboard (ft)	1.3	Overtopped*	2.6

\*Pond 2 Freeboard calculated to the top elevation of the Detention Pond 2 splitter dike

## 6.2 Channel Capacity

Golder proposes a series of ditches to convey flow off of the landfill surface. Flow depths are taken directly from the SSA model. When a channel is not directly modeled in the SSA program flow depth was calculated using the Manning equation (Equation 1) with a discharge equal to any direct discharge from the contributing basin. The Manning's N values for hydroturf and armorflex are taken, respectively, from AgruTurf design guidelines (Attachment A) and factor of safety calculations provided by Armortech (Attachment E). Table 10 shows a summary of the various channel configurations in use throughout the system. A minimum freeboard of at least 1 foot is required in all perimeter ditches. In terrace channels there is no freeboard requirement (depth of terrace channel is 1 foot).

**Table 10: Summary of Channel Type Geometries**

	Channel Type	Base Width (ft)	Side Slope 1 (h:v)	Side Slope 2 (h:v)	Total Depth(ft)	Manning's N	Liner Type
Triangular Terrace	Type 1	N/A	4	20	1	0.030	Riprap
Trapezoidal Side Channel	Type 2	2.7	4	2.5	2	0.030	Riprap
Perimeter Channel	Type 3	4.0	2.5	4	4	0.069	Riprap
Downslope Channels	Type 4	4.0	3	3	4	0.025	Armorflex

$$Equation\ 1: Q = \frac{1.49}{n} S^{0.5} x A x R h^{0.67}$$

**Table 11: Summary of Available Freeboard in Each Channel**

	Channel Type	Peak Flow (cfs)	Channel Slope (%)	Flow Depth (ft)	Freeboard (ft)
<b>Terrace Channels</b>					
Flow into Point 0.2	Type 1	41	3	0.6	0.4
Flow into Point 2	Type 1	34	3	0.9	0.1
Flow into Point 3	Type 1	29	3	0.5	0.6
Flow into Point 6	Type 1	26	3	0.5	0.5
Flow into Point 7	Type 1	38	3	0.6	0.4
Flow into Point 10	Type 1	26	3	0.4	0.6
Flow into Point 11	Type 1	25	3	0.4	0.6
Flow into Point 13.1	Type 1	15	6.8	0.2	0.8
<b>Trapezoidal Side Channels</b>					
Flow into Point 0.1	Type 2	11	1	0.3	1.7
Flow into Point 0.3	Type 2	25	5	1.2	0.8
Flow into Point 1	Type 2	97	5	1.8	0.2
Flow into Point 9	Type 2	24	8	0.6	1.4
Flow into Point 12	Type 2	23	11	0.6	1.4
Flow into Point 13	Type 2	5	0.08	1.1	0.9
Flow into Point 14.1	Type 2	4	20	.1	1.9
Flow into Point 18	Type 2	15	1	1.1	0.9
Flow into Point 18.1	Type 2	39	8	1.0	1.0
Flow into Point 18.2	Type 1	32	3	1.3	0.8
Flow into Point 19	Type 2	92	17	1.1	0.9
<b>Perimeter Channel</b>					
Flow into Point 4	Type 3	106	0.75	2.2	0.8
Flow into Point 7	Type 3	80	1	2.3	0.7
<b>Downslope Channel</b>					
Flow into Point 8	Type 4	59	16	.7	3.3
Flow into Point 14	Type 4	82	21	.8	3.2
Flow into Point 22	*	25	3	1.6	2.1

\*Flow into point 22 runs through an existing paved channel and is taken directly from SSA model. Freeboard is calculated using a top of road elevation of 824.7 and channel invert elevation of 820.5 ft-msl.

### 6.3 Ditch Stability

Golder has checked each proposed conveyance ditch for its ability to withstand shear stress from flow within the channel with methodology from HEC-15. Equation 2 gives the shear stress for a straight channel. The hydroturf liner is reinforced with grout and is highly resistant to erosion. For a more detailed calculation regarding Armortech lined channels see Attachment E. Table 12 shows the calculated shear stress in each channel section.

$$\text{Equation 2: } \tau = \gamma dS$$

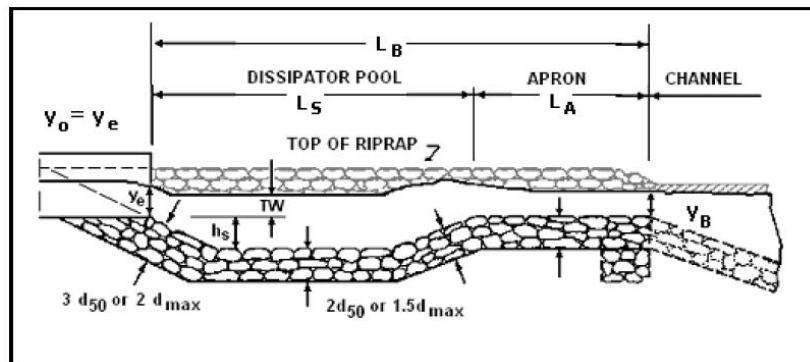
**Table 12: Summary of Shear Stress on Each Ditch Lining**

	Flow Height (ft)	Channel Slope (%)	Shear Stress (lb/ft <sup>2</sup> )	Channel Lining	Permissible Shear Stress (lb/ft <sup>2</sup> )	Safety Factor
Flow into Point 0.2	0.6	3.0	1.2	Riprap	4.6	3.8
Flow into Point 2	0.9	3.0	1.7	Riprap	4.6	2.7
Flow into Point 3	0.5	3.0	0.8	Riprap	4.6	5.5
Flow into Point 6	0.5	3.0	0.9	Riprap	4.6	4.9
Flow into Point 7	0.6	3.0	1.1	Riprap	4.6	4.1
Flow into Point 10	0.4	3.0	0.7	Riprap	4.6	6.1
Flow into Point 11	0.4	3.0	0.7	Riprap	4.6	6.1
Flow into Point 13.1	0.2	6.8	0.8	Riprap	4.6	5.4
Flow into Point 0.1	0.3	0.3	0.1	Riprap	4.6	81.9
Flow into Point 0.3	1.2	1.2	0.9	Riprap	4.6	5.1
Flow into Point 1	1.8	0.9	1.0	Riprap	4.6	4.8
Flow into Point 9	0.6	0.6	0.2	Riprap	4.6	20.1
Flow into Point 12	0.6	0.6	0.2	Riprap	4.6	21.2
Flow into Point 13	1.1	1.1	0.8	Riprap	4.6	6.1
Flow into Point 14.1	0.1	0.1	0.0	Riprap	4.6	921.5
Flow into Point 18	1.1	1.0	0.7	Riprap	4.6	6.7
Flow into Point 18.1	1.0	1.0	0.6	Riprap	4.6	7.1
Flow into Point 18.2	1.3	1.3	1.0	Riprap	4.6	4.5
Flow into Point 19	1.1	1.2	0.8	Riprap	4.6	5.6
Flow into Point 4	2.2	0.8	1.4	Riprap	4.6	4.3
Flow into Point 7	2.3	1.0	1.4	Riprap	4.6	4.3
Flow into Point 8	0.7	16.0	7.0	Armorflex	25	3.2
Flow into Point 14	0.8	21.0	10.5	Armorflex	25	2.4

## 6.4 Energy Dissipation

### 6.4.1 Stilling Basins

Golder proposes an energy dissipation system to remove energy from flow traveling along each downslope channel. Golder proposes a riprap basin at the end of each downslope channel in line with the methodology in Chapter 10 of HEC-14. Figure 2 shows a profile view of a typical riprap basin as



proposed. The proposed design however uses armorflex articulated block the length of the basin (L<sub>S</sub>) and transitions to riprap for the apron section (L<sub>A</sub>). Equations 4-10 outline the necessary steps and information required to size a basin as outlined in Figure 2.

Figure 2: Profile View of Energy Dissipation Basin

$$\text{Equation 3: } Fr_o = \frac{v_o}{\sqrt{gy_o}}$$

$$\text{Equation 4: } C_o = 1.4 \quad \frac{TW}{y_e} < 0.75$$

$$C_o = 4.0 \left( \frac{TW}{y_e} \right) - 1.6 \quad 0.75 < \frac{TW}{y_e} < 1.0$$

$$C_o = 2.4 \quad 1.0 < \frac{TW}{y_e}$$

$$\text{Equation 5: } \frac{h_s}{y_e} = 0.86 \left( \frac{D_{50}}{y_e} \right)^{-0.55} \left( \frac{v_o}{\sqrt{gy_e}} \right) - C_o$$

$$\text{Equation 6: } \frac{Q^2}{g} = \frac{A_c^3}{T_c} = (y_c(W_B + zy_c))^3 / (W_B + 2zy_c)$$

$$\text{Equation 7: } L_S = 10h_s \text{ must be minimum of } 3W_o$$

$$\text{Equation 8: } L_A = 5h_s \text{ must be minimum of } W_o$$

$$\text{Equation 9: } W_B = 2W_o + 2(L_S + L_A)/3$$

6.4.1.1 North Downslope Channel

Entrance Flow	Q	62.4	cfs	
Initial Flow Depth	$y_o$	1.1	ft	
Initial Flow Velocity	$v_o$	14.0	ft/s	
Channel Flow Width	$W_o$	10.6	ft	
Froude Number	Fr	2.3		
Trial Riprap Size	$D_{50}$	0.4	ft	
	$D_{50}/y_o$	0.4		must be greater than 0.1
Tailwater Height	TW	2.6	ft	
	$TW/y_o$	2.4		
	$C_o$	2.4		taken from Equation 4
Stilling Basin Height	$h_s$	1.2	ft	
	$h_s/D_{50}$	3.1		must be greater than 2
Riprap Lining Thickness	$2*D_{50}$	0.8	ft	
Dissipator Pool Length*	$L_s$	12.3	ft	32 ft
Apron Length*	$L_A$	6.1	ft	11 ft
Basin Width	$W_B$	38.9	ft	
*Use minimum value				
	$Q^2/g$	120.9		
Trial Exit Flow Depth	$y_c$	2.6	ft	
Basin Side Slope	z	3.0		
Confirm	$Q^2/g$	120.9		
Exit Area	$A_c$	121.3	ft <sup>2</sup>	
Exit Velocity	$V_c$	0.5	ft/s	



6.4.1.2 South Downslope Channel

Entrance Flow	Q	81.8	cfs	
Initial Flow Depth	$y_o$	0.8	ft	
Initial Flow Velocity	$v_o$	14.7	ft/s	
Channel Top Flow Width	$W_o$	8.7	ft	
Froude Number	Fr	2.9		
Trial Riprap Size	$D_{50}$	0.6	ft	
	$D_{50}/y_o$	0.8		must be greater than 0.1
Tailwater Height	TW	0.1	ft	
	$TW/y_o$	0.1		
	$C_o$	1.4		taken from Equation 4
Stilling Basin Height	$h_s$	1.2	ft	
	$h_s/D_{50}$	2.0		must be greater than 2
Riprap Lining Thickness	$2*D_{50}$	1.2	ft	
Dissipator Pool Length*	$L_s$	11.9	ft	26 ft
Apron Length*	$L_A$	6.0	ft	9 ft
Basin Width	$W_B$	32.0	ft	
*Use minimum value				
	$Q^2/g$	283.2		
Trial Exit Flow Depth	$y_c$	3.1	ft	
Basin Side Slope	z	3.0		
Confirm	$Q^2/g$	283.2		
Exit Area	$A_c$	128.2	ft <sup>2</sup>	
Exit Velocity	$V_c$	0.7	ft/s	

**6.4.1.3 Stilling Basin Summary and HEC-RAS Modelling**

Table 13 gives a summary of all relevant basin dimensions as determined in sections 6.4.1.1 and 6.4.1.2. Using the values from Table 13, Golder has developed a HEC-RAS model for both the north and south downslope channels. Cross sections were developed using the proposed channel geometry. A maximum stilling basin height of 6 feet is proposed to give adequate freeboard within the basin. Table 14 gives the HEC-RAS results.

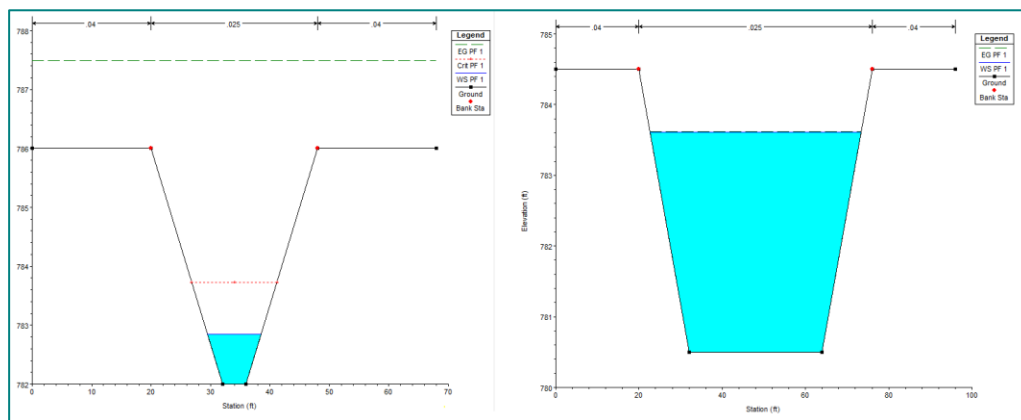
**Table 13: Summary of Stilling Basin Dimensions**

	North Channel	South Channel	
Riprap Size (D <sub>50</sub> )	0.4	0.6	ft
Initial Basin Width	10.6	8.7	ft
Final Basin Width	38.9	32.0	ft
Stilling Basin Depth	1.2	1.2	ft
Stilling Basin Length	31.8	26.2	ft
Apron Length	10.6	8.7	ft
Total Length	42.4	35.0	ft

**Table 14: Summary of Jump Height in Each Stilling Basin**

	Hydraulic Jump Height (ft)	Basin Height (ft)	Freeboard in Basin (ft)
South Channel	3.1	6.0	2.9
North Channel	2.7	6.0	3.3

Figure 3 shows a depiction of the southern downslope channel before and after the hydraulic jump as modelled in the HEC-RAS program.



**Figure 3: View of Flow in Southern Downslope Channel Before (Left) and After (Right) Hydraulic Jump**

### 6.4.2 Riprap Aprons

Energy dissipation is also required at all pipe culvert outlets. Golder designed riprap aprons at each outlet based on the design guidelines set forth in the Georgia Stormwater Management Manual Volume 2. Figure 4 and Figure 5 show the apron sizing criteria under different tailwater conditions.

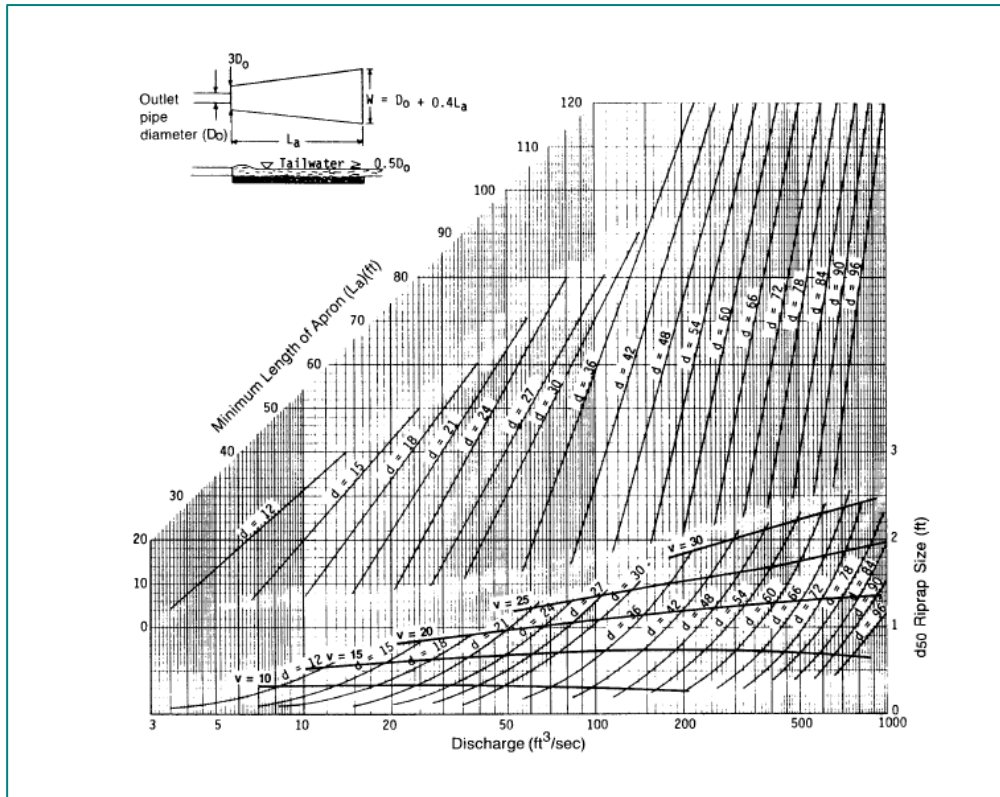
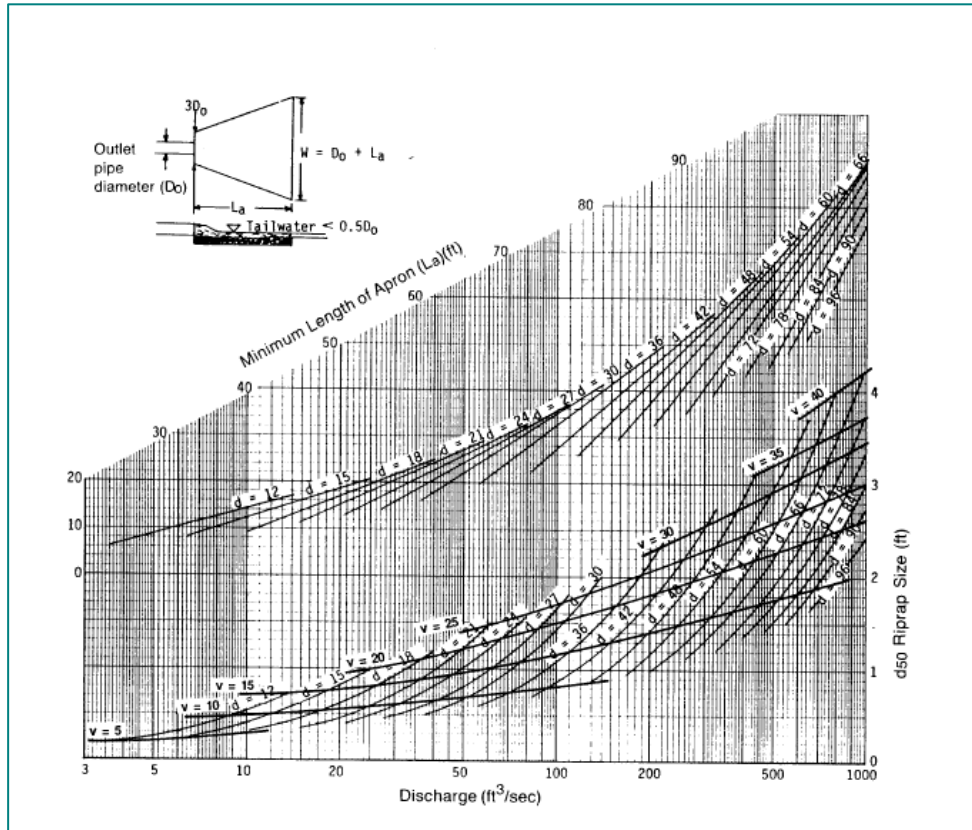


Figure 4: Riprap Apron Dimensions Under Maximum Tailwater Conditions



**Figure 5: Riprap Apron Dimensions Under Minimum Tailwater Conditions**

Table 15 shows the riprap apron dimensions at each applicable culvert outlet, meaning outlets discharging onto clean-closed, non HydroTurf, sections of landfill. Tailwater conditions at each outlet were determined individually based on results from the SSA model. All riprap aprons will use GDOT Type III riprap (D50 = .75 feet) and a riprap thickness of 1.5 feet.

**Table 15: Riprap Apron Dimensions**

	Pipe Diameter or Flow Depth (in)	Outlet Flow (cfs)	Outlet Velocity (ft/s)	Min Riprap Size D50 (ft)	Apron Initial Width (ft)	Apron Final Width (ft)	Minimum Apron Length (ft)
Culvert Outlet Downstream of Point 9 (Max Tailwater)	36	48	14	0.5	9	33	20
Culvert Outlet Downstream of Point 13 (Max Tailwater)	24	21	9	0.5	6	14	20
Culvert Outlet Downstream of Point 13.1 (Min Tailwater)	7	5	9	0.5	6	10	10
Culvert Outlet Into Pond 1 (Max Tailwater)	36	68	6	0.5	18	38	20
Culvert Outlet Out of Pond 3 (Min Tailwater)	16	11	6	0.5	4.5	8.5	10
Culvert Outlet Downstream of Point 4.1 (Max Tailwater)	16	10	9	0.4	4.5	16.5	12
Culvert Outlet Out of Pond 1 (Min Tailwater)	22	12	7	0.5	6	16	10

### 6.5 Maximum AgruTurf Drainage Length

Golder determined the maximum permissible flow length on the proposed AgruTurf liner. Based on design guidelines from Agruturf, there exists a maximum flow length before the sand infill within the liner will be displaced. Figure 6 shows the maximum permissible drainage length over Agruturf. Rainfall intensity was taken from the NOAA Atlas 14. To ensure that flow remained below the maximum flow lengths below, bench channels were added at set intervals down the 4:1 side slope of the landfill. These channels are to be lined with Hydroturf, which has no maximum drainage length.

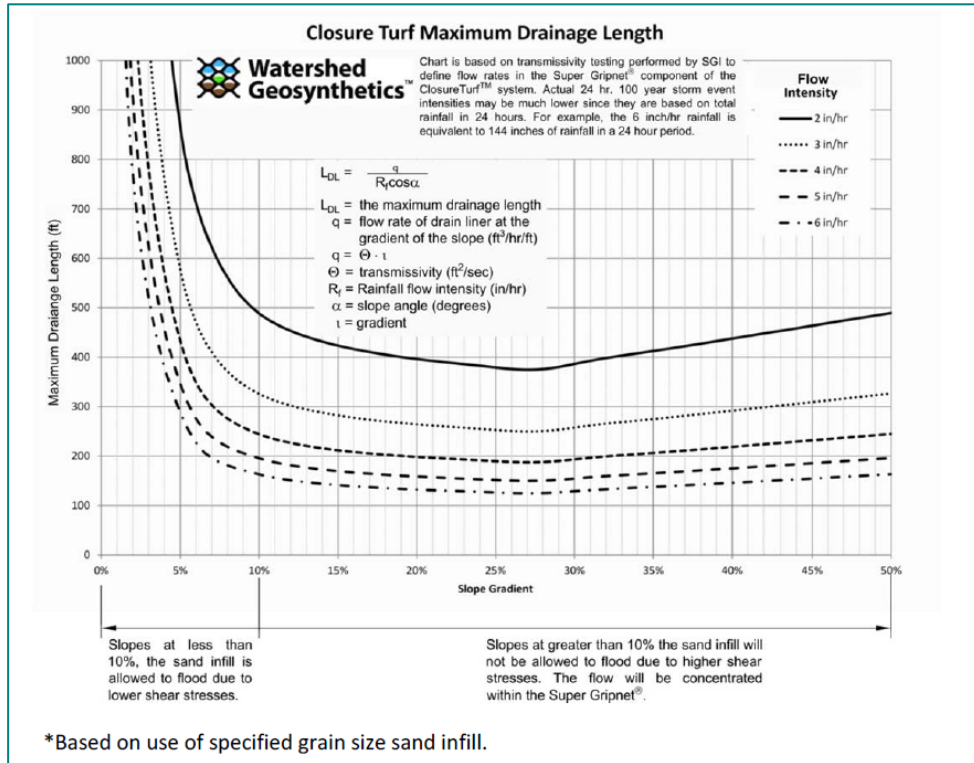


Figure 6: Maximum Drainage Lengths Over AgruTurf

Rainfall Intensity	4 in/hr	For 60 minute duration
For 4% slope (liner top)	N/A	ft maximum flow length
For 25% slope	190	ft maximum flow length
Maximum Proposed Sheet Flow Length	160 ft	At interface between basin 1 and basin 2

## 7.0 GA SAFE DAMS STORAGE REQUIREMENTS

Golder has examined the existing available site storage to determine the site's capacity to store runoff from the GA Safe Dams design storm for a large category dam. The existing conditions are seen as the worst case scenario during construction as ash will be gradually excavated from area around Detention Pond 2 increasing site storage through the construction process. The design storm for this category of dam is the 6 hour half probable maximum precipitation (PMP) storm. This storm depth as taken from the HMR 51 manual is 15.25 inches. To make a conservative estimate it was assumed that all precipitation from the storm event was converted to runoff and in need of storage capacity. The following calculation details the necessary storage requirement for this design storm under the given assumptions:

PMP Depth	30.5 in	from HMR51
1/2 PMP	15.25 in	
Drainage Area	63.6 acre	On-site basins as described in Section 5.0, without area draining to Detention Pond 3
Assuming 100% Runoff, 1/2 PMP Total Runoff Volume	80.8 acre-ft	

An existing site storage curve was generated from topography provided by the Georgia Land Department and Metro Engineering and Surveying Co, INC. from 10-16-2012, and can be seen in Table 16. With a top of dam elevation of 846 ft-msl there is approximately 7 feet of freeboard during the half PMP storm event. See Attachment F for an existing conditions plan view which shows the existing topography.

**Table 16: Existing Stage-Storage**

Elevation (ft-msl)	Area (sf)	Area (acres)	Volume (acre-ft)
819	3507	0.08	0.00
820	14955	0.34	0.21
822	46359	1.06	1.62
824	77147	1.77	4.45
826	103201	2.37	8.60
828	133084	3.06	14.02
830	196467	4.51	21.58
835	355750	8.17	53.28
838	687041	15.77	89.19
840	716129	16.44	121.40
842	750817	17.24	155.08
844	1049756	24.10	196.41

In order to maintain storage ash excavation must proceed to certain levels as the outer dam is lowered. At the onset of construction the prescribed storm event is the half PMP, as previously described. Once the dam height is lowered to below 35 feet, the dam transitions to a medium category dam size and the design storm transitions to the one-third PMP storm (storm depth of 10.17 inches). Table 17 shows the minimum excavation level (at the proposed grading configuration) in the pond as the outer berm is lowered. To excavate the outer dam below an elevation of 795 ft-msl the Pond 2 outlet structure must be in place and operational. In order to reach the final embankment elevation of 790 ft-msl, the outlet structure must be functioning and all ash must be excavated.

**Table 17: Required Pond Excavation Levels During Outer Berm Lowering**

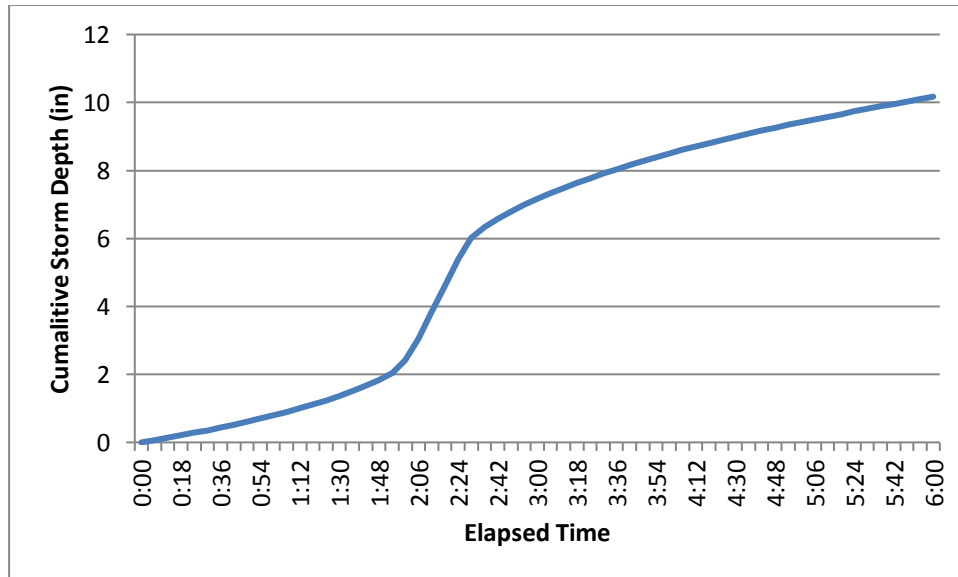
DAM ELEVATION (FT-MSL)	DAM HEIGHT TO LOWEST DOWNSTREAM GRADE OF 763 FT-MSL (FT)	GEORGIA SAFE DAMS PROGRAM DESIGN STORM	DESIGN STORM RUN-ON VOLUME (ACRE-FT)	INTERIOR ASH MAXIMUM ELEVATION ADJACENT TO DAM REMOVAL AREAS (FT-MSL)
846.0	83.0	50% PMP	80.8	N/A
840.0	77.0	50% PMP	80.8	835
835.0	72.0	50% PMP	80.8	830.0
830.0	67.0	50% PMP	80.8	824.0
825.0	62.0	50% PMP	80.8	819.0
820.0	57.0	50% PMP	80.8	813.0
815.0	52.0	50% PMP	80.8	807.0
810.0	47.0	50% PMP	80.8	801.0
805.0	42.0	50% PMP	80.8	794.0
800.0	37.0	50% PMP	80.8	784.0
795.0	32.0	33% PMP	53.9	780.0
790.0	27.0	33% PMP	53.9	ASH REMOVED

Golder has also routed the one-third PMP storm event through the proposed final closure plan SSA model. A SITES storm distribution (as taken from the National Resources Conservation Service SITES hydrology program) is used to create a storm hyetograph as shown in Figure 7. Because all proposed stormwater infrastructure is sized for the 100 year, 24 hour storm the SSA model was updated to ensure that all stormwater at each study point is conveyed to the downstream node (not flooded out of the system). Table 18 summarizes the resulting storage during the one-third PMP storm event in Pond 2.



**Table 18: One-Third PMP Required Storage in Proposed System**

	Peak Elevation (ft-msl)	Top of Dam Elevation (ft-msl)	Freeboard (ft)	Peak Storage Volume (ft <sup>3</sup> )	Peak Storage Volume (acre-ft)
Pond 2	787.8	790	2.2	1,170,369	26.9



**Figure 7: SITES One-Third PMP Storm Distribution**

## 8.0 REFERENCES

Georgia Stormwater Management Manual Volume 2

NOAA Atlas 14 Online Database

Agru Closure Turf Design Guidelines

TR55 Urban Hydrology for Small Watersheds

HEC-15 Design of Roadside Channels with Flexible Linings

HEC-14 Energy Dissipators

HMR 51 Probable Maximum Precipitation Estimates, United States East of the 105<sup>th</sup> Meridian

## APPENDIX A

## 5.0 Hydrology

### 5.1 ClosureTurf® Hydrology Parameters

Currently, many regulatory agencies are requiring run-off curve numbers (RCN) of 95-98 of a typical landfill closure. ClosureTurf's RCN should be calculated between 92 and 95. This number was derived by TRI Environmental, Inc. and Colorado State University Hydraulics Laboratory in separate tests. Table 2 below shows the typical TR-55 design parameters for Hydrology using ClosureTurf®.

Closure Turf® Hydrology		
	TR-55 Data	
		Curve Number Depends on Rain Intensity
Sheet Flow	Manning's n	
	Slopes >10%	0.12
	Slopes <10%	0.22
	Flow Length	100'-300' dependent on Manning's n until a depth of not more than 0.1 foot is attained in the 2yr 24hr rainfall
	2yr-24hr Rain	SCS
	Land Slope	design
Shallow Concentrated Flow	Flow Length	design
	Slope	design
	Surface (paved/unpaved)	Paved
	X-Sect Area	ft <sup>2</sup>
Channel Flow	Wetted Perimeter	Linear Feet
	Channel Slope	ft/ft
	Manning's n	0.03 <sup>2</sup>
	Flow Length	design

1. RCN ranging from 92 in High Intensity Rainfalls to 95 in normal rainfall events.

2. Manning's n for channel flow will vary with depth of flow.

Table 2: ClosureTurf® TR-55 Data

## **APPENDIX B**

Manning's equation is:

$$V = \frac{1.49r^{\frac{2}{3}}s^{\frac{1}{2}}}{n} \quad [\text{eq. 3-4}]$$

where:

- V = average velocity (ft/s)
- r = hydraulic radius (ft) and is equal to  $a/p_w$
- a = cross sectional flow area (ft<sup>2</sup>)
- $p_w$  = wetted perimeter (ft)
- s = slope of the hydraulic grade line (channel slope, ft/ft)
- n = Manning's roughness coefficient for open channel flow.

Manning's n values for open channel flow can be obtained from standard textbooks such as Chow (1959) or Linsley et al. (1982). After average velocity is computed using equation 3-4,  $T_t$  for the channel segment can be estimated using equation 3-1.

### Reservoirs or lakes

Sometimes it is necessary to estimate the velocity of flow through a reservoir or lake at the outlet of a watershed. This travel time is normally very small and can be assumed as zero.

### Limitations

- Manning's kinematic solution should not be used for sheet flow longer than 300 feet. Equation 3-3 was developed for use with the four standard rainfall intensity-duration relationships.
- In watersheds with storm sewers, carefully identify the appropriate hydraulic flow path to estimate  $T_c$ . Storm sewers generally handle only a small portion of a large event. The rest of the peak flow travels by streets, lawns, and so on, to the outlet. Consult a standard hydraulics textbook to determine average velocity in pipes for either pressure or nonpressure flow.
- The minimum  $T_c$  used in TR-55 is 0.1 hour.

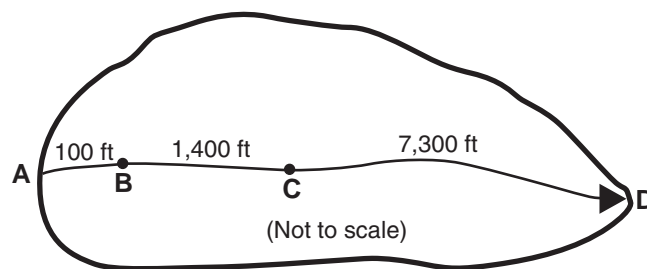
- A culvert or bridge can act as a reservoir outlet if there is significant storage behind it. The procedures in TR-55 can be used to determine the peak flow upstream of the culvert. Detailed storage routing procedures should be used to determine the outflow through the culvert.

### Example 3-1

The sketch below shows a watershed in Dyer County, northwestern Tennessee. The problem is to compute  $T_c$  at the outlet of the watershed (point D). The 2-year 24-hour rainfall depth is 3.6 inches. All three types of flow occur from the hydraulically most distant point (A) to the point of interest (D). To compute  $T_c$ , first determine  $T_t$  for each segment from the following information:

Segment AB: Sheet flow; dense grass; slope ( $s$ ) = 0.01 ft/ft; and length ( $L$ ) = 100 ft. Segment BC: Shallow concentrated flow; unpaved;  $s$  = 0.01 ft/ft; and  $L$  = 1,400 ft. Segment CD: Channel flow; Manning's  $n$  = .05; flow area ( $a$ ) = 27 ft<sup>2</sup>; wetted perimeter ( $p_w$ ) = 28.2 ft;  $s$  = 0.005 ft/ft; and  $L$  = 7,300 ft.

See figure 3-2 for the computations made on worksheet 3.



## APPENDIX C

Detention Pond 1

<u>Low Flow Orifice</u>			<u>High Flow Weir</u>			<u>Pipe/Barrel</u>			<u>Emergency Spillway</u>		
Calculated Average Cpv Flow	0.48	cfs	Weir Invert Elev	836	ft msl	Barrel Diameter	1.750583	ft	Emergency Invert	838	ft msl
Low Orifice Diameter, D	0.25	ft	Weir Length	2	ft	Manning's n	0.012	SDR17 HDPE	Weir Length	12	ft
Orifice Discharge Coefficient, C <sub>o</sub>	0.6		Weir Height	2	ft	XS Area	2.406886	sq ft	XS Area of Riser	16	ft <sup>2</sup>
XS Area of Orifice, A	0.049087	sq. ft	Weir XS Area	4	sq ft	Outlet Inv	825.9	ft msl			
Acceleration due to gravity, g	32.2	ft/s <sup>2</sup>	road-Crested Weir Coefficient, C <sub>w</sub>	3.1		Coefficient of minor losses, km	1				
						pipe friction loss coef, kp	0.012638		Length	4	ft
						Pipe Length	214.54	ft	Width	4	ft

Elevation	Riser										Barrel							Total Outflow	
	Low Flow		Q <sub>p25</sub> / High Flow					Q <sub>i</sub> / Emerg. Spillway			Inlet			Outlet		Barrel			
			Weir		Orifice						Geometry		Orifice		Pipe				
	H	Q <sub>low</sub>	H	Q	H	Q	Q <sub>high</sub>	H	Q	Q <sub>riser</sub>	H	θ	Area	H	Q	H	Q		Q <sub>barrel</sub>
ft msl	ft	cfs	ft	cfs	ft	cfs		ft	cfs		ft	radians	sq ft	ft	cfs	ft	cfs	cfs	cfs
828	-0.125	0	0	0	0	0	0	0	0	0	0	0	0	0	--	1.224708	9.85	9.85	0.00
829	0.875	0.221089	0	0	0	0	0	0	0	0.221089	1	3.427518	1.42	0.124708	2.416242	2.224708	13.27	2.42	0.22
830	1.875	0.323642	0	0	0	0	0	0	0	0.323642	2	6.283185	2.41	1.124708	12.2905	3.224708	15.98	12.29	0.32
831	2.875	0.400759	0	0	0	0	0	0	0	0.400759	3	6.283185	2.41	2.124708	16.89271	4.224708	18.29	16.89	0.40
832	3.875	0.465265	0	0	0	0	0	0	0	0.465265	4	6.283185	2.41	3.124708	20.48587	5.224708	20.34	20.34	0.47
833	4.875	0.521857	0	0	0	0	0	0	0	0.521857	5	6.283185	2.41	4.124708	23.53674	6.224708	22.20	22.20	0.52
834	5.875	0.572886	0	0	0	0	0	0	0	0.572886	6	6.283185	2.41	5.124708	26.23519	7.224708	23.92	23.92	0.57
835	6.875	0.619727	0	0	0	0	0	0	0	0.619727	7	6.283185	2.41	6.124708	28.68087	8.224708	25.52	25.52	0.62
836	7.875	0.663268	0	0	0	0	0	0	0	0.663268	8	6.283185	2.41	7.124708	30.93379	9.224708	27.03	27.03	0.66
837	8.875	0.704123	1	5.704	0	0	5.704	0	0	6.408123	9	6.283185	2.41	8.124708	33.03342	10.22471	28.45	28.45	6.41
838	9.875	0.742733	2	16.13335	0	0	16.13335	0	0	16.87608	10	6.283185	2.41	9.124708	35.00734	11.22471	29.81	29.81	16.88
839	10.875	0.779433	2	16.13335	0	0	16.13335	1	34.224	51.13678	11	6.283185	2.41	10.12471	36.87575	12.22471	31.11	31.11	31.11
840	11.875	0.814481	2	16.13335	0	0	16.13335	2	96.80009	113.7479	12	6.283185	2.41	11.12471	38.65396	13.22471	32.36	32.36	32.36
841	12.875	0.848082	2	16.13335	0	0	16.13335	3	177.8331	194.8146	13	6.283185	2.41	12.12471	40.35388	14.22471	33.56	33.56	33.56
842	13.875	0.880401	2	16.13335	0	0	16.13335	4	273.792	290.8057	14	6.283185	2.41	13.12471	41.98503	15.22471	34.72	34.72	34.72
843	14.875	0.911575	2	16.13335	0	0	16.13335	5	382.636	399.6809	15	6.283185	2.41	14.12471	43.55514	16.22471	35.84	35.84	35.84



**Detention Pond 3**

<u>Low Flow Orifice</u>		<u>High Flow Weir</u>		<u>Pipe/Barrel</u>		<u>Emergency Spillway</u>	
Calculated Average Cpv Flow	0.48 cfs	Weir Invert Elev	841 ft msl	Barrel Diameter	1.312917 ft	Emergency Invert	843 ft msl
Low Orifice Diameter, D	0.25 ft	Weir Length	2 ft	Manning's n	0.012 SDR17 HDPE	Weir Length	12 ft
Orifice Discharge Coefficient, C <sub>o</sub>	0.6	Weir Height	2 ft	XS Area	1.35383 sq ft	XS Area of Riser	16 ft <sup>2</sup>
XS Area of Orifice, A	0.049087 sq. ft	Weir XS Area	4 sq ft	Outlet Inv	829 ft msl		
Acceleration due to gravity, g	32.2 ft/s <sup>2</sup>	road-Crested Weir Coefficient, C <sub>w</sub>	3.1	Coefficient of minor losses, km	1		
				pipe friction loss coef, kp	0.018547	<u>Riser Dimensions</u>	
				Pipe Length	97.2 ft	Length	4 ft
						Width	4 ft

Elevation	Riser										Barrel							Total Outflow	
	Low Flow		High Flow					Emergency Spillway	Riser	Inlet			Orifice		Outlet		Barrel		
			Weir		Orifice			Weir			Geometry					Pipe			
	H	Q <sub>low</sub>	H	Q	H	Q	Q <sub>high</sub>	H	Q	Q <sub>riser</sub>	H	θ	Area	H	Q	H	Q		Q <sub>barrel</sub>
ft msl	ft	cfs	ft	cfs	ft	cfs	ft	cfs	ft	cfs	ft	radians	sq ft	ft	cfs	ft	cfs	cfs	cfs
832.8	-0.125	0	0	0	0	0	0	0	0	0	0	0	0	0	--	3.143542	9.88	9.88	0.00
833	0.075	0.064728	0	0	0	0	0	0	0.064728	0.2	1.603821	0.23	0	--	3.343542	10.19	10.19	0.06	
834	1.075	0.245058	0	0	0	0	0	0	0.245058	1.2	5.092624	2.31	0.543542	8.18784	4.343542	11.61	8.19	0.25	
835	2.075	0.340466	0	0	0	0	0	0	0.340466	2.2	6.283185	2.41	1.543542	14.39822	5.343542	12.88	12.88	0.34	
836	3.075	0.414464	0	0	0	0	0	0	0.414464	3.2	6.283185	2.41	2.543542	18.48286	6.343542	14.03	14.03	0.41	
837	4.075	0.47712	0	0	0	0	0	0	0.47712	4.2	6.283185	2.41	3.543542	21.81566	7.343542	15.10	15.10	0.48	
838	5.075	0.532454	0	0	0	0	0	0	0.532454	5.2	6.283185	2.41	4.543542	24.70284	8.343542	16.09	16.09	0.53	
839	6.075	0.582555	0	0	0	0	0	0	0.582555	6.2	6.283185	2.41	5.543542	27.28622	9.343542	17.03	17.03	0.58	
840	7.075	0.628677	0	0	0	0	0	0	0.628677	7.2	6.283185	2.41	6.543542	29.64532	10.34354	17.92	17.92	0.63	
841	8.075	0.671638	0	0	0	0	0	0	0.671638	8.2	6.283185	2.41	7.543542	31.83005	11.34354	18.76	18.76	0.67	
842	9.075	0.712012	1	5.704	0	0	5.704	0	6.416012	9.2	6.283185	2.41	8.543542	33.87417	12.34354	19.57	19.57	6.42	
843	10.075	0.750216	2	16.13335	0	0	16.13335	0	16.88356	10.2	6.283185	2.41	9.543542	35.80176	13.34354	20.35	20.35	16.88	
844	11.075	0.786567	2	16.13335	0	0	16.13335	1	34.224	51.14392	11.2	6.283185	2.41	10.54354	37.63075	14.34354	21.10	21.10	21.10
845	12.075	0.821311	2	16.13335	0	0	16.13335	2	96.80009	113.7547	12.2	6.283185	2.41	11.54354	39.37487	15.34354	21.82	21.82	21.82
846	13.075	0.854643	2	16.13335	0	0	16.13335	3	177.8331	194.8211	13.2	6.283185	2.41	12.54354	41.04495	16.34354	22.52	22.52	22.52

**APPENDIX D**

## Time of Concentration Calculations

### Node 0.1 Basin

#### Sheet Flow

*Mannings coefficient	n	0.22	*Mannings coefficient taken from Attachment A
Sheet Flow Length	l	33 ft	
2 yr, 24 hr Rainfall	P <sub>2</sub>	3.73 in	
**Slope of Land Surface	S	0.03 ft/ft	
Travel Time	T <sub>t1</sub>	0.07 hr	

#### Shallow Concentrated Flow

Segment Length	l	610 ft	
Slope of Land Surface	S	0.01 ft/ft	
Short Grass Landuse			
*Flow Velocity	V	1.6 ft/s	*Flow velocity taken from NEH Part 630, Figure 15-4
Travel Time	T <sub>t2</sub>	0.11 hr	

TOTAL TIME  
0.18 hr  
10.67 mins

### Node 0.2 Basin

#### Sheet Flow

*Mannings coefficient	n	0.22	*Mannings coefficient taken from Attachment A
Sheet Flow Length	l	200 ft	
2 yr, 24 hr Rainfall	P <sub>2</sub>	3.73 in	
**Slope of Land Surface	S	0.03 ft/ft	
Travel Time	T <sub>t1</sub>	0.30 hr	

#### Shallow Concentrated Flow

Segment Length	l	740 ft	
Slope of Land Surface	S	0.01 ft/ft	
Short Grass Landuse			
*Flow Velocity	V	1.6 ft/s	*Flow velocity taken from NEH Part 630, Figure 15-4
Travel Time	T <sub>t2</sub>	0.13 hr	

**Channel Flow 1**

Up Invert		894.00 ft-msl
Down Invert		866.00 ft-msl
Length	l	915.00 ft
Slope	s	0.03 ft/ft

Bottom Width	a	0.00 ft
Side Slope 1		4.00 :1
Side Slope 2		20.00 :1
Channel Height	h	1.00 ft
Wetted Perimeter	$P_w$	24.15 ft
Channel Area	A	12.00 ft <sup>2</sup>
Hydraulic Radius	r	0.50 ft

Mannings Coefficient n 0.03

Velocity V 5.45 ft/s

Travel Time  $T_{13}$  0.05 hr

TOTAL TIME 0.48 hr  
28.76 mins

**Node 0.3 Basin**

Node 0.3 basin assumed to have minimum TOC of 6 mins

**Node 1 Basin****Sheet Flow**

*Mannings coefficient	n	0.22	*Mannings coefficient taken from Attachment A
Sheet Flow Length	l	140 ft	
2 yr, 24 hr Rainfall	$P_2$	3.73 in	
**Slope of Land Surface	S	0.25 ft/ft	
Travel Time	$T_{11}$	0.10 hr	

**Channel Flow 1**

Up Invert		846.00 ft-msl
Down Invert		838.00 ft-msl
Length	l	140.00 ft
Slope	s	0.06 ft/ft

Bottom Width	a	2.70 ft
Side Slope		3.00
Channel Height	h	1.00 ft
Wetted Perimeter	$P_w$	7.32 ft
Channel Area	A	5.70 ft <sup>2</sup>
Hydraulic Radius	r	0.78 ft

Mannings Coefficient n 0.03

Velocity V 10.04 ft/s

Travel Time  $T_{13}$  0.00 hr

TOTAL TIME 0.10 hr  
6.11 mins



**Shallow Concentrated Flow**

Segment Length	I	0 ft	
Slope of Land Surface	S	0.25 ft/ft	
Short Grass Landuse			
*Flow Velocity	V	8.5 ft/s	*Flow velocity taken from NEH Part 630,
Travel Time	$T_{12}$	0.00 hr	Figure 15-4

**Channel Flow 2**

Up Invert		841.00 ft-msl	
Down Invert		834.00 ft-msl	
Length	I	1115.00 ft	
Slope	s	0.01 ft/ft	
Bottom Width	a	5.60 ft	
Side Slope		3.00	
Channel Height	h	6.00 ft	
Wetted Perimeter	$P_w$	43.95 ft	
Channel Area	A	141.60 ft <sup>2</sup>	
Hydraulic Radius	r	3.22 ft	
Mannings Coefficient	n	0.04	
Velocity	V	7.36 ft/s	
Travel Time	$T_{13}$	0.04 hr	
TOTAL TIME		0.20 hr	
		11.73 mins	

### Node 5 Basin

Node 5 basin assumed to have minimum TOC of 6 mins

### Node 6 Basin

#### Sheet Flow

*Mannings coefficient	n	0.22	*Mannings coefficient taken from Attachment A
Sheet Flow Length	l	95 ft	
2 yr, 24 hr Rainfall	P <sub>2</sub>	3.73 in	
**Slope of Land Surface	S	0.03 ft/ft	
Travel Time	T <sub>t1</sub>	0.17 hr	

#### Shallow Concentrated Flow

Segment Length	l	0 ft	
Slope of Land Surface	S	0.25 ft/ft	
Short Grass Landuse			
*Flow Velocity	V	8.5 ft/s	*Flow velocity taken from NEH Part 630, Figure 15-4
Travel Time	T <sub>t2</sub>	0.00 hr	

#### Channel Flow 1

Up Invert		860.00 ft-msl
Down Invert		832.00 ft-msl
Length	l	912.00 ft
Slope	s	0.03 ft/ft
Bottom Width	a	0.00 ft
Side Slope 1		4.00 :1
Side Slope 2		20.00 :1
Channel Height	h	1.00 ft
Wetted Perimeter	P <sub>w</sub>	24.15 ft
Channel Area	A	12.00 ft <sup>2</sup>
Hydraulic Radius	r	0.50 ft
Mannings Coefficient	n	0.03
Velocity	V	5.46 ft/s
Travel Time	T <sub>t3</sub>	0.05 hr

TOTAL TIME  
0.21 hr  
12.85 mins





### Node 8 Basin

#### Sheet Flow

*Mannings coefficient	n	0.22	*Mannings coefficient taken from Attachment A
Sheet Flow Length	l	200 ft	
2 yr, 24 hr Rainfall	P <sub>2</sub>	3.73 in	
**Slope of Land Surface	S	0.25 ft/ft	
Travel Time	T <sub>t1</sub>	0.13 hr	
TOTAL TIME		0.13 hr	
		7.82 mins	

### Node 9 Basin

#### Sheet Flow

*Mannings coefficient	n	0.22	*Mannings coefficient taken from Attachment A
Sheet Flow Length	l	102 ft	
2 yr, 24 hr Rainfall	P <sub>2</sub>	3.73 in	
**Slope of Land Surface	S	0.25 ft/ft	
Travel Time	T <sub>t1</sub>	0.08 hr	

#### Channel Flow 2

Up Invert		816.00 ft-msl
Down Invert		782.00 ft-msl
Length	l	360.00 ft
Slope	s	0.09 ft/ft
Bottom Width	a	2.70 ft
Side Slope		3.00
Channel Height	h	1.00 ft
Wetted Perimeter	P <sub>w</sub>	7.32 ft
Channel Area	A	5.70 ft <sup>2</sup>
Hydraulic Radius	r	0.78 ft
Mannings Coefficient	n	0.03
Velocity	V	12.91 ft/s
Travel Time	T <sub>t3</sub>	0.01 hr
TOTAL TIME		0.08 hr
		5.03 mins

### Node 10 Basin

#### Sheet Flow

*Mannings coefficient	n	0.22	*Mannings coefficient taken from Attachment A
Sheet Flow Length	l	100 ft	
2 yr, 24 hr Rainfall	P <sub>2</sub>	3.73 in	
**Slope of Land Surface	S	0.25 ft/ft	
Travel Time	T <sub>t1</sub>	0.07 hr	

### Shallow Concentrated Flow

Segment Length	I	0 ft	
Slope of Land Surface	S	0.25 ft/ft	
Short Grass Landuse			
*Flow Velocity	V	8.5 ft/s	*Flow velocity taken from NEH Part 630,
Travel Time	$T_{12}$	0.00 hr	Figure 15-4

### Channel Flow 1

Up Invert		860.00 ft-msl
Down Invert		832.00 ft-msl
Length	I	950.00 ft
Slope	s	0.03 ft/ft

Bottom Width	a	0.00 ft
Side Slope 1		4.00 :1
Side Slope 2		20.00 :1
Channel Height	h	1.00 ft
Wetted Perimeter	$P_w$	24.15 ft
Channel Area	A	12.00 ft <sup>2</sup>
Hydraulic Radius	r	0.50 ft

Mannings Coefficient n 0.03

Velocity V 5.35 ft/s

Travel Time  $T_{13}$  0.05 hr

TOTAL TIME 0.12 hr  
7.45 mins

### Node 11 Basin

#### Sheet Flow

*Mannings coefficient	n	0.22	*Mannings coefficient taken from Attachment
Sheet Flow Length	I	125 ft	A
2 yr, 24 hr Rainfall	$P_2$	3.73 in	
**Slope of Land Surface	S	0.25 ft/ft	
Travel Time	$T_{11}$	0.09 hr	

**Channel Flow 1**

Up Invert		832.00 ft-msl
Down Invert		808.00 ft-msl
Length	l	800.00 ft
Slope	s	0.03 ft/ft

Bottom Width	a	0.00 ft
Side Slope 1		4.00 :1
Side Slope 2		20.00 :1
Channel Height	h	1.00 ft
Wetted Perimeter	$P_w$	24.15 ft
Channel Area	A	12.00 ft <sup>2</sup>
Hydraulic Radius	r	0.50 ft

Mannings Coefficient n 0.03

Velocity V 5.40 ft/s

Travel Time  $T_{13}$  0.04 hr

TOTAL TIME 0.13 hr  
7.84 mins

**Node 12 Basin****Sheet Flow**

*Mannings coefficient	n	0.22	*Mannings coefficient taken from Attachment A
Sheet Flow Length	l	120 ft	
2 yr, 24 hr Rainfall	$P_2$	3.73 in	
**Slope of Land Surface	S	0.25 ft/ft	
Travel Time	$T_{11}$	0.09 hr	

**Channel Flow 1**

Up Invert		802.00 ft-msl
Down Invert		784.00 ft-msl
Length	l	570.00 ft
Slope	s	0.03 ft/ft

Bottom Width	a	0.00 ft
Side Slope 1		4.00 :1
Side Slope 2		20.00 :1
Channel Height	h	1.00 ft
Wetted Perimeter	$P_w$	24.15 ft
Channel Area	A	12.00 ft <sup>2</sup>
Hydraulic Radius	r	0.50 ft

Mannings Coefficient n 0.03

Velocity V 5.54 ft/s

Travel Time  $T_{13}$  0.03 hr

TOTAL TIME 0.12 hr  
6.91 mins

### Node 13.0 Basin

#### Sheet Flow

*Mannings coefficient	n	0.22	*Mannings coefficient taken from Attachment A
Sheet Flow Length	l	148 ft	
2 yr, 24 hr Rainfall	P <sub>2</sub>	3.73 in	
**Slope of Land Surface	S	0.25 ft/ft	
Travel Time	T <sub>11</sub>	0.10 hr	

#### Channel Flow 2

Up Invert		800.00 ft-msl
Down Invert		780.00 ft-msl
Length	l	300.00 ft
Slope	s	0.07 ft/ft

Bottom Width	a	4.00 ft
Side Slope		3.00
Channel Height	h	2.00 ft
Wetted Perimeter	P <sub>w</sub>	14.65 ft
Channel Area	A	20.00 ft <sup>2</sup>
Hydraulic Radius	r	1.37 ft

Mannings Coefficient	n	0.03
----------------------	---	------

Velocity	V	15.78 ft/s
----------	---	------------

Travel Time	T <sub>13</sub>	0.01 hr
-------------	-----------------	---------

TOTAL TIME		0.11 hr
		6.46 mins

### Node 14 Basin

#### Sheet Flow

*Mannings coefficient	n	0.22	*Mannings coefficient taken from Attachment A
Sheet Flow Length	l	200 ft	
2 yr, 24 hr Rainfall	P <sub>2</sub>	3.73 in	
**Slope of Land Surface	S	0.04 ft/ft	
Travel Time	T <sub>11</sub>	0.27 hr	

#### Shallow Concentrated Flow

Segment Length	l	21 ft	
Slope of Land Surface	S	0.04 ft/ft	
Short Grass Landuse			
*Flow Velocity	V	3.5 ft/s	*Flow velocity taken from NEH Part 630, Figure 15-4
Travel Time	T <sub>12</sub>	0.00 hr	

**Channel Flow 2**

Up Invert		840.00 ft-msl
Down Invert		830.00 ft-msl
Length	l	923.00 ft
Slope	s	0.01 ft/ft
Bottom Width	a	4.00 ft
Side Slope		3.00
Channel Height	h	2.00 ft
Wetted Perimeter	$P_w$	14.65 ft
Channel Area	A	20.00 ft <sup>2</sup>
Hydraulic Radius	r	1.37 ft
Mannings Coefficient	n	0.03
Velocity	V	6.36 ft/s
Travel Time	$T_{13}$	0.04 hr
TOTAL TIME		0.31 hr
		18.79 mins



### Node 16 Basin

#### Sheet Flow 1

*Mannings coefficient	n	0.22
Sheet Flow Length	l	145 ft
2 yr, 24 hr Rainfall	P <sub>2</sub>	3.73 in
<b>**Slope of Land Surface</b>	<b>S</b>	<b>0.25 ft/ft</b>
Travel Time	T <sub>t1</sub>	0.10 hr

\*Mannings coefficient taken from Attachment A

#### Sheet Flow 2

*Mannings coefficient	n	0.22
Sheet Flow Length	l	50 ft
2 yr, 24 hr Rainfall	P <sub>2</sub>	3.73 in
<b>**Slope of Land Surface</b>	<b>S</b>	<b>0.025 ft/ft</b>
Travel Time	T <sub>t1</sub>	0.11 hr

\*Mannings coefficient taken from Attachment A

TOTAL TIME  
0.21 hr  
12.52 mins

### Node 17 Basin

#### Sheet Flow

*Mannings coefficient	n	0.22
Sheet Flow Length	l	142 ft
2 yr, 24 hr Rainfall	P <sub>2</sub>	3.73 in
<b>**Slope of Land Surface</b>	<b>S</b>	<b>0.25 ft/ft</b>
Travel Time	T <sub>t1</sub>	0.10 hr

\*Mannings coefficient taken from Attachment A

#### Sheet Flow

*Mannings coefficient	n	0.22
Sheet Flow Length	l	53 ft
2 yr, 24 hr Rainfall	P <sub>2</sub>	3.73 in
<b>**Slope of Land Surface</b>	<b>S</b>	<b>0.04 ft/ft</b>
Travel Time	T <sub>t1</sub>	0.09 hr

\*Mannings coefficient taken from Attachment A

TOTAL TIME  
0.19 hr  
11.57 mins





**Channel Flow 1**

Up Invert		894.00 ft-msl
Down Invert		870.00 ft-msl
Length	l	900.00 ft
Slope	s	0.03 ft/ft
Bottom Width	a	0.00 ft
Side Slope 1		4.00 :1
Side Slope 2		20.00 :1
Channel Height	h	1.00 ft
Wetted Perimeter	$P_w$	24.15 ft
Channel Area	A	12.00 ft <sup>2</sup>
Hydraulic Radius	r	0.50 ft
Mannings Coefficient	n	0.03
Velocity	V	5.09 ft/s
Travel Time	$T_{13}$	0.05 hr
TOTAL TIME		0.44 hr 26.40 mins

**Node 19 Basin****Sheet Flow**

*Mannings coefficient	n	0.22	*Mannings coefficient taken from Attachment A
Sheet Flow Length	l	122 ft	
2 yr, 24 hr Rainfall	$P_2$	3.73 in	
**Slope of Land Surface	S	0.25 ft/ft	
Travel Time	$T_{11}$	0.09 hr	
TOTAL TIME		0.09 hr 5.26 mins	

**Node 20 Basin****Sheet Flow**

*Mannings coefficient	n	0.22	*Mannings coefficient taken from Attachment A
Sheet Flow Length	l	70 ft	
2 yr, 24 hr Rainfall	$P_2$	3.73 in	
**Slope of Land Surface	S	0.25 ft/ft	
Travel Time	$T_{11}$	0.06 hr	

**Channel Flow 1**

Up Invert		884.00 ft-msl
Down Invert		848.00 ft-msl
Length	l	1190.00 ft
Slope	s	0.03 ft/ft

Bottom Width	a	0.00 ft
Side Slope 1		4.00 :1
Side Slope 2		20.00 :1
Channel Height	h	1.00 ft
Wetted Perimeter	$P_w$	24.15 ft
Channel Area	A	12.00 ft <sup>2</sup>
Hydraulic Radius	r	0.50 ft

Mannings Coefficient n 0.03

Velocity V 5.42 ft/s

Travel Time  $T_{13}$  0.06 hr

TOTAL TIME 0.12 hr  
7.03 mins

**Node 21 Basin****Sheet Flow**

*Mannings coefficient	n	0.22	*Mannings coefficient taken from Attachment A
Sheet Flow Length	l	130 ft	
2 yr, 24 hr Rainfall	$P_2$	3.73 in	
**Slope of Land Surface	S	0.25 ft/ft	
Travel Time	$T_{11}$	0.09 hr	

**Channel Flow 1**

Up Invert		852.00 ft-msl
Down Invert		840.00 ft-msl
Length	l	410.00 ft
Slope	s	0.03 ft/ft

Bottom Width	a	0.00 ft
Side Slope 1		4.00 :1
Side Slope 2		20.00 :1
Channel Height	h	1.00 ft
Wetted Perimeter	$P_w$	24.15 ft
Channel Area	A	12.00 ft <sup>2</sup>
Hydraulic Radius	r	0.50 ft

Mannings Coefficient n 0.03

Velocity V 5.33 ft/s

Travel Time  $T_{13}$  0.02 hr

TOTAL TIME 0.11 hr  
6.82 mins

## APPENDIX E

## **Factor of Safety Hydraulic Analysis**

These calculations are an application of the Moment Stability Analysis technique presented in Julien (2010) and as illustrated in the NCMA Manual (2010), listed in the References.

The factor of safety method is used in the selection of block sizes for ACB's for revetments or bed armor.

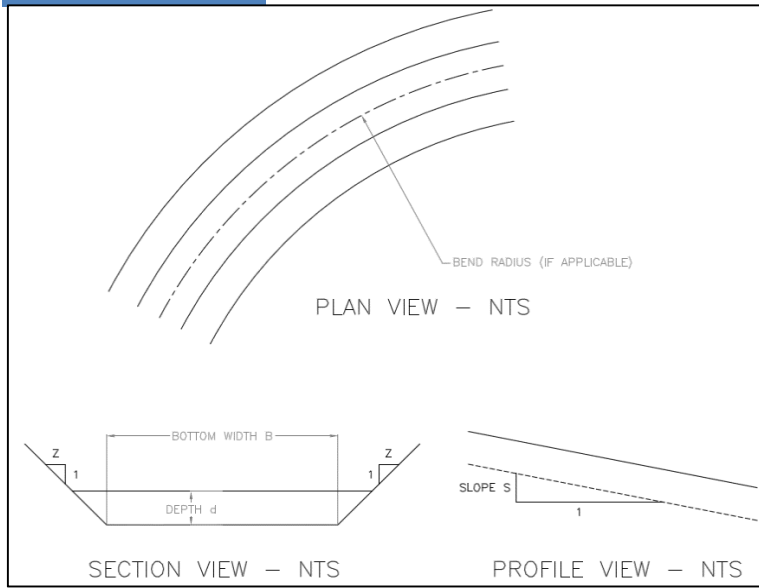
The following assumes that hydraulic testing has been performed for the block system to quantify a critical shear stress; the use of Manning's equation conservatively assumes normal depth and critical velocity.

### References

1. Julien, Pierre Y. (2010) "Erosion and Sedimentation", 2nd Edition, Cambridge University Press
  
2. National Concrete Masonry Association (2010), "Design Manual for Articulating Concrete Block (ACB) Revetment Systems", NCMA Publication TR220A.
  
3. USDOT Federal Highway Administration Hydraulic Engineering Circular No. 15, Third Edition (2005) "Design of Roadside Channels with Flexible Linings", National Highway Institute.
  
4. FHWA Hydraulic Engineering Circular No. 23: Bridge Scour and Stream Instability Countermeasures: Experience, Selection and Design Guidance - Third Edition, Volume II, Design Guideline 8.
  
5. ASTM D 7276 & D7277 Testing and Analysis Compliant, See Contech Tapered Testing Report

# Factor of Safety Hydraulic Analysis

## Project Data



Channel Bottom Width, B	4	ft
Bed Slope, $S_o$	0.21	ft/ft
Left Side Slope, $Z_L$	3	(_H:1V)
Right Side Slope, $Z_R$	3	(_H:1V)
Bend Radius, r	0	ft
Depth of Flow d	0.79	ft

*The Depth of Flow is varied iteratively to obtain a given volumetric flow rate.*

Top Surface Width, T	8.76	ft
Other Constants		

Density of Water, $\gamma$	62.4	pcf
Density of Concrete, Dry-Cast	130	pcf
Sp. Gr. Of Concrete, $S_c$	2.083	--
Gravitational Constant, g	32.2	ft/s <sup>2</sup>

### Calculated Channel Geometry Factors

Flow Area, A	5.07	ft <sup>2</sup>
Wetted Perimeter, P	9.02	ft
Hydraulic Radius = $R_H = A/P =$	0.56	ft
Bend Coefficient, $K_b$	1	--
Froude Number, Fr	3.67	--
Flow Type	Supercritical	
Largest Side Slope Angle, $\theta_1$	18.435	°
Bed Slope Angle, $\theta_0$	11.860	°

Volumetric Flow Rate, Q	94.00	cfs
-------------------------	-------	-----

*The Volumetric Flow Rate is determined using Manning's equation:*

$$Q = 1.486 / (n * A * R^{2/3} * S^{1/2})$$

Velocity, V	18.55	ft/sec
Friction Slope, S	0.210	ft/ft

*The Friction slope is assumed to be equal to the bed slope, which further assumes uniform flow.*

### ArmorFlex Block parameters

Class	40-T
SF	1.97

$\vartheta_1$	0.198	ft
$\vartheta_2$	0.971	ft
$\vartheta_3$	0.317	ft
$\vartheta_4$	0.971	ft

Weight	58.1	lbs
Width	1.292	ft
$\tau_c$	25.0	psf
$\Delta Z$	0.0	in
n	0.025	--



## Factor of Safety Hydraulic Analysis

### Detailed Calculations

### REFERENCE

Flow Area,  $A = A_L + A_B + A_R$

$A_L = \frac{1}{2} * d^2 * Z_L =$	0.95	ft <sup>2</sup>
$A_B = B * d =$	3.18	ft <sup>2</sup>
$A_R = \frac{1}{2} * d^2 * Z_R =$	0.95	ft <sup>2</sup>
$A =$	5.07	ft <sup>2</sup>

Wetted Perimeter,  $P = P_L + P_B + P_R$

$P_L = d * (Z_L^2 + 1)^{0.5} =$	2.51	ft
$P_B = B =$	4	ft
$P_R = d * (Z_R^2 + 1)^{0.5} =$	2.51	ft
$P =$	9.02	ft

Volumetric Flow Rate,  $Q$

$$Q = 1.486 / n * A * R_H^{2/3} * S^{1/2} = \boxed{94.00} \text{ cfs}$$

(Ref. 3 Eqn. 2.1)

Compute Factor of Safety Parameters

Submerged Weight,  $W_s$

$$W_s = W * ((S_c - 1) / S_c) = \boxed{30.2} \text{ lb}$$

(Ref. 2 Eqn 4.13a)

Applied Shear Stress,  $\tau_o$

$$\tau_o = \gamma * d * S_o = \boxed{10.41} \text{ psf}$$

(Ref. 3 Eqn. 2.4)

Bend Coefficient Calculation

$X = r/B = (\text{Constrained to between 1.984 and 10})$	1.984	--
Calculated $K_b = 2.38 - 0.206(X) + 0.0073(X)^2 =$	2.00	--
Constrained $K_b: 1.05 \leq K_b \leq 2 \rightarrow$	1.00	--

(If no bend radius is present,  $K_b = 1$ )

(Ref. 3 Eqn. 3.7)

Step 1: Compute Factor of Safety Parameters

(Design Shear Stress)

$$\tau_o = K_b \gamma y \sin(\tan^{-1} S_o) = \boxed{10.18} \text{ lbs/ft}^2$$

(Ref. 3 Eqn 3.1 & 3.6)

(Stability Number for Horizontal Surface)

$$\eta_o = \tau_o / \tau_c = \boxed{0.41} \text{ --}$$

(Ref. 2 Eqn 4.12a)

$$a_\theta = (\cos^2 \theta_1 - \sin^2 \theta_0)^{1/2} = \boxed{0.93} \text{ }^\circ$$

(Ref. 2 Eqn 4.10a)

$$\theta = \arctan((\sin \theta_0 * \cos \theta_1) / (\sin \theta_1 * \cos \theta_0)) = \boxed{32.2} \text{ }^\circ$$

(Ref. 2 Eqn 4.9a)

$$\beta = \arctan((\cos(\theta_0 + \theta) / ((\vartheta_4 / \vartheta_3 + 1) * (1 - a_\theta^2)^{1/2} / (\eta_o * \vartheta_2 / \vartheta_1) + \sin(\theta_0 + \theta))) = \boxed{26.15} \text{ }^\circ$$

(Ref. 2 Eqn 4.8a)

(Stability Number for Slope Surface)

$$\eta_1 = ((\vartheta_4 / \vartheta_3 + \sin(\theta_0 + \theta + \beta)) / (\vartheta_4 / \vartheta_3 + 1)) * \eta_o = \boxed{0.40} \text{ --}$$

(Ref. 2 Eqn 4.7a)

$$\delta = 90^\circ - \beta - \theta = \boxed{31.64} \text{ }^\circ$$

(Ref. 2 Eqn 4.6a)

Step 2: Consider Effects for Specified Projection (Assumes lift and drag forces are equal)

$$F_L = F_D = 0.5 \Delta Z b \rho V_{des}^2 = \boxed{0.00} \text{ lbs}$$

(Ref. 2 Eqn. 2.2)

Step 3: Compute Factor of Safety

$$SF = (\vartheta_2 / \vartheta_1 * a_\theta) / ((1 - a_\theta^2)^{1/2} * \cos \beta + \eta_1 * (\vartheta_2 / \vartheta_1) + (\vartheta_3 * F_D' * \cos \delta + \vartheta_4 * F_L') / (\vartheta_1 * W_s)) =$$

$$\boxed{1.97} \text{ --}$$

(Ref. 2 Eqn 4.5a)

## Factor of Safety Hydraulic Analysis

### Detailed Calculations

If H = horizontal component of side slope, then  $\theta_1 = \tan^{-1} (1/H)$

If S = bed slope, then  $\theta_0 = \tan^{-1} (S)$

**For  $\tau_0$ :**

$$\tan^{-1} S_0 = 11.86$$

$$\sin (\tan^{-1} S_0) = 0.206$$

**For  $a_\theta$ :**

$$\cos \theta_1 = 0.949$$

$$\cos^2 \theta_1 = 0.900$$

$$\sin \theta_0 = 0.206$$

$$\sin^2 \theta_0 = 0.042$$

**For  $\theta$ :**

$$\sin \theta_0 * \cos \theta_1 = 0.195$$

$$(\sin \theta_0 * \cos \theta_1) / (\sin \theta_1 * \cos \theta_0) = 0.630$$

$$\sin \theta_1 = 0.316$$

$$\cos \theta_0 = 0.979$$

$$\sin \theta_1 * \cos \theta_0 = 0.309$$

**For  $\beta$ :**

$$\cos (\theta_0 + \theta) = 0.718$$

$$(\vartheta_4 / \vartheta_3 + 1) * (1 - a_0^2)^{1/2} / (\eta_0 * \vartheta_2 / \vartheta_1) = 0.7677$$

$$\vartheta_4 / \vartheta_3 + 1 = 4.063$$

$$(\vartheta_4 / \vartheta_3 + 1) * (1 - a_0^2)^{1/2} / (\eta_0 * \vartheta_2 / \vartheta_1) + \sin (\theta_0 + \theta) = 1.463$$

$$(1 - a_0^2)^{1/2} = 0.377$$

$$\cos (\theta_0 + \theta) / ((\vartheta_4 / \vartheta_3 + 1) * (1 - a_0^2)^{1/2} / (\eta_0 * \vartheta_2 / \vartheta_1) + \sin (\theta_0 + \theta)) = 0.491$$

$$\eta_0 * \vartheta_2 / \vartheta_1 = 1.996$$

$$\sin (\theta_0 + \theta) = 0.696$$

**For  $\eta_1$ :**

$$\vartheta_4 / \vartheta_3 = 3.063$$

$$\vartheta_4 / \vartheta_3 + \sin (\theta_0 + \theta + \beta) = 4.004$$

$$\sin (\theta_0 + \theta + \beta) = 0.941$$

$$(\vartheta_4 / \vartheta_3 + \sin (\theta_0 + \theta + \beta)) / (\vartheta_4 / \vartheta_3 + 1) = 0.9855$$

$$\vartheta_4 / \vartheta_3 + 1 = 4.063$$

$$\eta_0 = 0.407$$

**For SF:**

$$\vartheta_2 / \vartheta_1 * a_0 = 4.542$$

$$(\vartheta_3 * F_D' * \cos \delta + \vartheta_4 * F_L') / (\vartheta_1 * W_s) = 0.000$$

$$(1 - a_0^2)^{1/2} * \cos \beta = 0.339$$

$$(1 - a_0^2)^{1/2} * \cos \beta + \eta_1 * (\vartheta_2 / \vartheta_1) + (\vartheta_3 * F_D' * \cos \delta + \vartheta_4 * F_L') / (\vartheta_1 * W_s) = 2.3056$$

$$\eta_1 * (\vartheta_2 / \vartheta_1) = 1.967$$

$$\cos \delta = 0.851$$

$$\vartheta_3 * F_D' * \cos \delta + \vartheta_4 * F_L' = 0.000$$

$$\vartheta_1 * W_s = 5.984$$

## Factor of Safety Hydraulic Analysis

<i>Parameters for Factor of Safety Calculations</i>								
Block Class	Submerged	$\vartheta_1$	$\vartheta_2$	$\vartheta_3$	$\vartheta_4$	$\tau_c$	Width	Weight
	Weight					0 Degrees		
	(lbs)	(ft)	(ft)	(ft)	(ft)	(psf)	(ft)	(lbs)
30-S	17.10	0.198	0.726	0.317	0.726	5.180	0.967	32.89
40	30.69	0.198	0.971	0.317	0.971	11.200	1.292	59.02
40-L	50.53	0.198	1.222	0.317	1.222	19.460	1.967	97.18
40-T	30.22	0.198	0.971	0.317	0.971	25.022	1.292	58.12
45	37.05	0.198	0.971	0.317	0.971	13.530	1.292	71.25
45-L	56.76	0.198	1.222	0.317	1.222	21.860	1.967	109.15
45-S	20.38	0.198	0.726	0.317	0.726	6.170	0.967	39.20
50	39.67	0.250	0.971	0.400	0.971	13.610	1.292	76.29
50-L	60.33	0.250	1.222	0.400	1.222	22.050	1.967	116.02
50-S	21.86	0.250	0.726	0.400	0.726	6.130	0.967	42.03
50-T	39.20	0.250	0.971	0.400	0.971	30.500	1.292	75.39
55	47.51	0.250	0.971	0.400	0.971	16.290	1.292	91.37
55-L	71.91	0.250	1.222	0.400	1.222	26.280	1.967	138.29
55-S	26.13	0.250	0.726	0.400	0.726	7.330	0.967	50.25
60	48.45	0.313	0.971	0.500	0.971	15.490	1.292	93.17
60-T	48.58	0.313	0.971	0.500	0.971	35.200	1.292	93.42
70	59.23	0.375	0.971	0.600	0.971	17.730	1.292	113.90
70-L	90.72	0.375	1.222	0.600	1.222	29.520	1.967	174.46
70-T	56.66	0.375	0.971	0.600	0.971	38.500	1.292	108.96
75	58.25	0.313	0.971	0.500	0.971	18.620	1.292	112.02
85	70.51	0.375	0.971	0.600	0.971	21.100	1.292	135.60
85-L	107.76	0.375	1.222	0.600	1.222	35.060	1.967	207.23

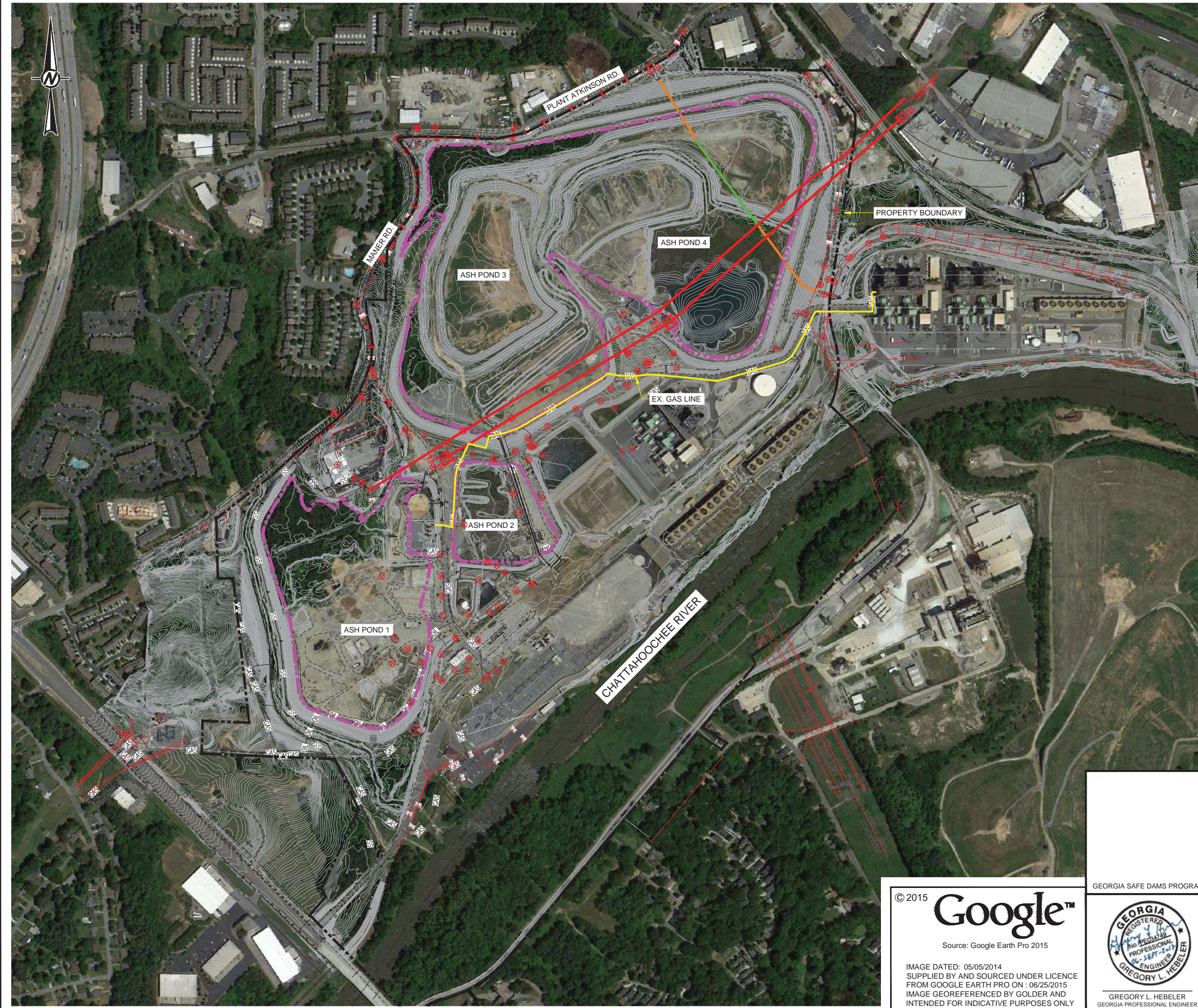
NOTE: Moment Arms and critical shear stresses assume blocks are oriented with the long axis parallel to the flow direction.

NOTE: Submerged weight assumes minimum concrete density of 130 lbs/CF and water density of 62.4 lbs/CF.

	$\vartheta_1$	$\vartheta_2$	$\vartheta_3$	$\vartheta_4$	$\tau_c$	Width	Weight
40-T	0.198	0.971	0.317	0.971	25.022	1.292	58.120



## APPENDIX F



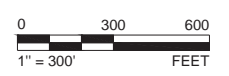
**LEGEND**

- EXISTING CONTOURS
- PROPERTY BOUNDARY MARKERS/LIMITS
- EXISTING UNPAVED PLANT ROAD
- EXISTING STREAM DIVERSION CULVERT UNDER EMBANKMENTS
- EXISTING STREAM DIVERSION CULVERT-CONCRETE ENCASED SECTION
- EXISTING OVERHEAD ELECTRIC LINES IN ASH POND 3 & 4 AREA TO REMAIN & TO BE PROTECTED
- APPROXIMATE EXISTING ASH LIMITS
- EXISTING GAS LINE

**REFERENCES**

1. THE EXISTING TOPOGRAPHY AND CONTOUR ELEVATIONS WERE PROVIDED BY GEORGIA LAND DEPARTMENT AND METRO ENGINEERING AND SURVEYING CO, INC. THE DATE OF THE SURVEY PROVIDED AND SHOWN ON THIS SET OF PLANS IS 10-16-2012. REFER TO THE SURVEY DRAWING TITLED "TOPOGRAPHIC MAP PREPARED FOR GEORGIA POWER COMPANY PLANT MCDONOUGH - GEORGIA STATE PLANE WEST SURVEY FEET - DATE OF PHOTOGRAPHY 10-26-12. PROJECT NO. 13225 - 01-13-2013."
2. THE REVISED TOPOGRAPHY & CONTOUR ELEVATIONS WERE PROVIDED BY GEORGIA POWER LAND DEPARTMENT. THE DATA SHOWN IS AN UPDATE TO THE PLANS DONE ON 10-16-2012 & THE ONSITE CHANGES SINCE THAT 2012 SURVEY. THE REVISED SURVEY WAS DONE ON 1-12-2016 & MERGED WITH THE DATA ON 10-16-2012. GEORGIA POWER COMPANY PLANT MCDONOUGH ASH PONDS - GEORGIA STATE PLANE WEST SURVEY FEET - DATE OF SURVEY 1-12-2016 - LAND ENG. PROJECT # 20160020.
3. IMAGE TAKEN FROM GOOGLE EARTH PRO ON JUNE 25, 2015. IMAGE DATED MAY 05, 2014.

**SEPTEMBER 2017 - ISSUED FOR APPROVAL & CONSTRUCTION**



CLIENT  
**GEORGIA POWER COMPANY / SOUTHERN COMPANY SERVICES**

PROJECT  
**PLANT MCDONOUGH ASH POND NO. 3 & 4 CLOSURE PLAN**

TITLE  
**EXISTING CONDITIONS MAY 2014 SITE AERIAL**

CONSULTANT	YYYY-MM-DD	2016/01/21
DESIGNED	GLH	
PREPARED	RMS	
REVIEWED	GLH	
APPROVED	WRS	

PROJECT NO. 1539180	PROJECT ID MCD15017	REV. 2	SHEET 2
------------------------	------------------------	-----------	------------

© 2015 **Google™**  
 Source: Google Earth Pro 2015

IMAGE DATED: 05/05/2014  
 SUPPLIED BY AND SOURCED UNDER LICENCE FROM GOOGLE EARTH PRO ON : 06/25/2015  
 IMAGE GEOREFERENCED BY GOLDBER AND INTENDED FOR INDICATIVE PURPOSES ONLY

GEORGIA SAFE DAMS PROGRAM

GREGORY L. HEBELER  
 GEORGIA PROFESSIONAL ENGINEER  
 CERTIFICATE NUMBER 034749



Path: \\atlanta-cad\gs-southern\Company\1525193\_2015\Plant McDonough\PRODUCTION\DESIGN - File Name: 1525193\_02\_EX-COND - AERIAL.dwg

1 in IF THIS MEASUREMENT DOES NOT MATCH WHAT IS SHOWN, THE SHEET SIZE HAS BEEN MODIFIED FROM .ANSI D

**APPENDIX K**

**Analysis of Permanent Detention  
Pond 3 Outlet Structure**

## TECHNICAL MEMORANDUM

**DATE** August 2020

**Project No.** 1777449

**TO** Mr. Morgan French, SCS; Ms. Virginia Pantano, GPC; Ms. Alex Wild, GPC

**FROM** Greg Hebel, PE; James Grimes, PE; Lizmarie Steel, PE      **EMAIL** lizmarie\_steel@golder.com

### ANALYSIS OF PERMANENT POND 3 OUTLET STRUCTURE ATTENUATION / RETENTION TIMES

Golder has conducted an analysis to determine the time required to drain the permanent Pond 3 after a variety of 24-hour storm events for a variety of outlet configurations in order to determine the optimal outlet configuration to drain the pond completely in less than a day. The pond outlet design includes a multi-stage outlet including (1) a low-level orifice (the size of the low level orifice is determined in this analysis), (2) an elevated overflow weir in one side of the outlet structure, and (3) an upper overflow weir allowing inflow through the top grating of the Pond 3 outlet structure. The low-level outlet in the Pond 3 outlet riser drains the majority of the pond storage volume over an extended period of time after a storm event. This analysis examines a variety of low-level orifice conditions and examines the effect of each on the time required to drain Pond 3.

Golder estimated the time required to fully drain Pond 3 using the AP-3/4 final closure stormwater model utilizing the Autodesk Storm and Sanitary Analysis (SSA) Program. A detailed explanation of the site hydrology/hydraulics and stormwater model is provided in the Engineering Report for Plant McDonough CCR Unit AP-2 and AP-3/4 (Part B Section 2 of Permit Application) and Appendix J of this report. The SSA model provides estimated outlet times based on a Pond 3 outlet rating curve developed by Golder, combining the total flow through the low flow orifice/overflow weir and through the 18" SDR 17 HDPE riser outlet pipe. The rating curve for each analyzed condition is provided in Table 1. The provided storage in Pond 3 is based on the Golder final closure design.

**Table 1: Pond 3 Outlet Rating Curves**

Elevation (ft-msl)	Outflow (cfs)				Notes
	1 - 3" Orifice Outlet	1 - 6" Orifice Outlet	6 x 3" Orifice Outlets	Full Outlet Pipe Orifice Outlet*	
832.8	0.00	0.00	0.00	0.00	Orifice Invert
833	0.06	0.46	0.39	2.40	
834	0.25	0.92	1.47	4.81	
835	0.34	1.32	2.04	8.10	
836	0.41	1.62	2.49	10.40	

Elevation (ft-msl)	Outflow (cfs)				Notes
	1 - 3" Orifice Outlet	1 - 6" Orifice Outlet	6 x 3" Orifice Outlets	Full Outlet Pipe Orifice Outlet*	
837	0.48	1.88	2.86	12.27	
838	0.53	2.10	3.19	13.89	
839	0.58	2.31	3.50	15.35	
840	0.63	2.49	3.77	16.67	
841	0.67	2.67	4.03	17.90	Overflow Weir invert
842	6.42	8.53	9.98	19.57	
843	16.88	19.12	20.35	20.35	Upper Overflow Weir Invert
844	21.10	21.10	21.10	21.10	
845	21.82	21.82	21.82	21.82	
846	22.52	22.52	22.52	22.52	

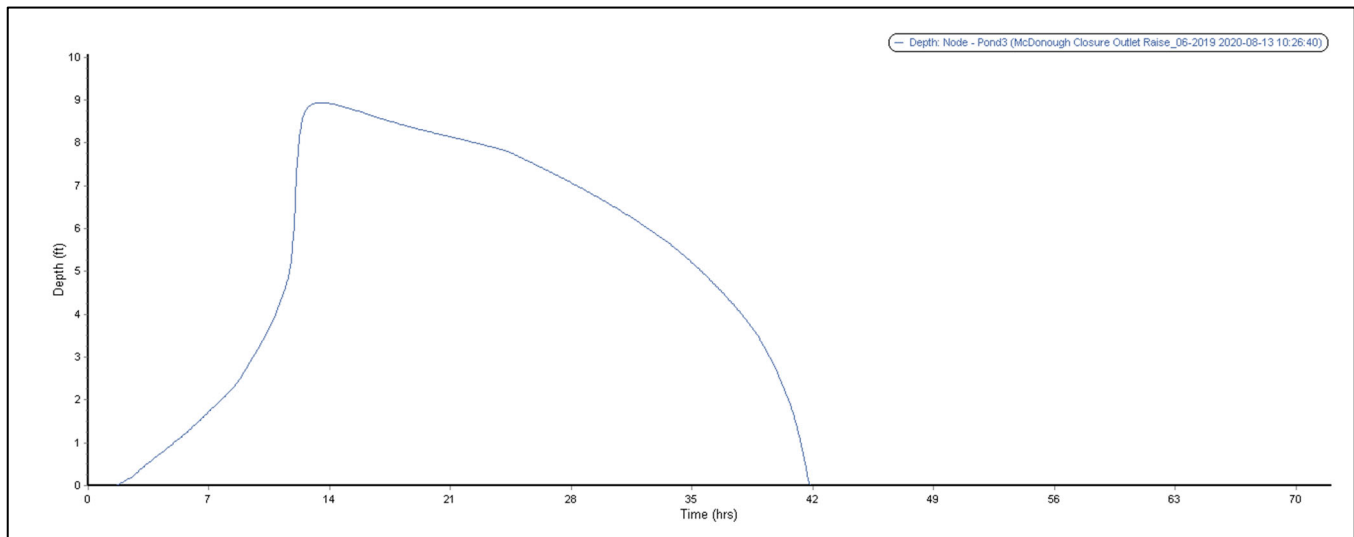
Table 2 provides the estimated times required for Pond 3 to drain for each analyzed storm event and low level orifice option. The times provided indicate the amount of time required to drain counting after the termination of the 24 hour storm event, as shown in Figure 1 for the recommended orifice condition. Golder has recommended the 6 x 3" orifice outlet configuration as it provides a drainage time under 1 day during the 100-year, 24-hour storm event while provided enough attenuation to protect the plant stormwater infrastructure downstream of the Pond 3 stormwater outlet.

**Table 2: Pond 3 Outlet Drain Time Periods 24 Hour Storms**

	Time Required to Fully Drain Pond 3 (Days After Rain Event Ends)			
	1 - 3" Orifice Outlet	1 - 6" Orifice Outlet	6 x 3" Orifice Outlets	Full Outlet Pipe Orifice Outlet*
0.75 in. Rain Event	0.4	0.0	0.0	0.0
1.5 in. Rain Event	1.5	0.0	0.0	0.0
2 year, 24 Hour (3.73 in)	4.3	0.7	0.3	0.0

	Time Required to Fully Drain Pond 3 (Days After Rain Event Ends)			
	1 - 3" Orifice Outlet	1 - 6" Orifice Outlet	6 x 3" Orifice Outlets	Full Outlet Pipe Orifice Outlet*
5 year, 24 Hour (4.45 in)	5.0	0.8	0.4	0.0
10 year, 24 Hour (5.06 in)	5.1	1.1	0.5	0.0
25 year, 24 Hour (6.00 in)	5.1	1.1	0.6	0.0
50 year, 24 Hour (6.74 in)	5.1	1.2	0.7	0.0
100 year, 24 Hour (7.52 in)	5.2	1.2	0.8	0.0

\*Current outlet modelled as inner diameter of the SDR17 18" culvert pipe (~15.8") – This change would require modification to the Pond 3 outlet armoring.



**Figure 1: Pond 3 Water Depth During the 100 Year, 24 Hour Storm Event (6 x 3" Low Level Orifice Configuration)**